



Purification of Parthenolide in Feverfew by Supercritical Fluid Extraction and Supercritical Fluid Chromatography with Evaporative Light Scattering Detection

Introduction

An evaporative light scattering detector (ELSD) is a versatile detector for use with a wide variety of compounds particularly those that are not readily measurable using UV absorption or fluorescence (with the exception of volatile compounds).

When an ELSD is used with supercritical fluid chromatography (SFC), the ELSD detection parameters should be optimized for the specific requirements of SFC separations.

In this application note we evaluated the effects on the chromatogram caused by changes to the ELSD detection parameters.

Feverfew (*Tanacetum parthenium*, Figure 1 picture of the Feverfew flower) is a medicinal herb and contains sesquiterpene lactone (Parthenolide structure Figure 2), which is reportedly the principle active component.

In this presentation, Parthenolide was purified from Feverfew using Supercritical fluid extraction (SFE) with a subsequent analysis by SFC with ELS detection.



JASCO Semi-preparative SFC/PDA/ELSD System



Figure 1. Feverfew

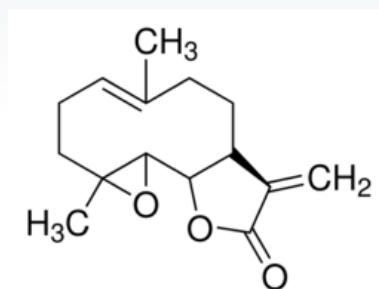

Figure 2. Structure of Parthenolide

Experimental

Instrument Figure 3. JASCO Semi-preparative SFC/PDA/ELSD system (JASCO Co., Tokyo, Japan)

Figure 4. Schematic of the SFC/PDA/ELSD System

Figure 5. Flow diagram of the SFE System.

Columns SFCpak SIL-5, 5 μ m, 4.6 mm ID x 250 mmL and SFCpak SIL-5SP, 5 μ m, 10.0 mm ID x 250 mmL

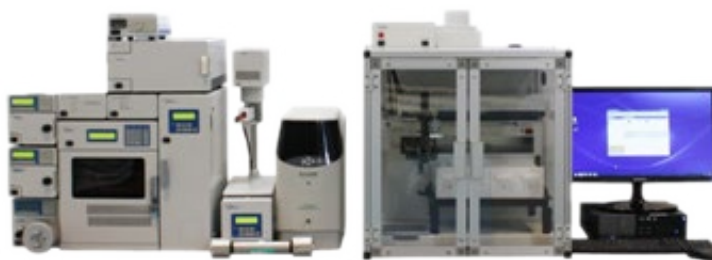
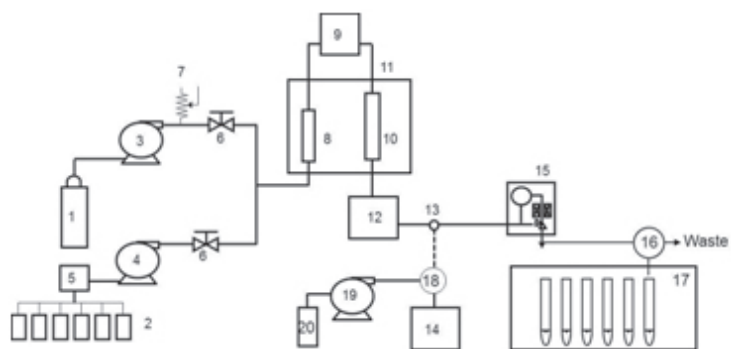

Figure 3. JASCO Semi-preparative SFC/PDA/ELSD System



1. CO₂ Cylinder

2. Modifier Solvent

3. PU-2086-CO₂

4. PU-2086 Modifier

5. LV-2080-03 Solvent Valve

6. SV-500 Stop Valve

7. Safety Valve

8. Mixer

9. AS-2059-SF Autosampler

10. Column

11. CO-2060 Column Oven

12. MD-2018 PDA Detector

13. Splitter

14. ELS-2041 ELSD Detector

15. BP-2080 Back Pressure Regulator

16. HV-2088-06 Fraction Valve

17. Fraction Collector

18. HV-2080-01 Switching Valve

19. PU-2080 Make-up Pump

20. Make-up Solvent

Figure 4. Schematic of the JASCO Semi-preparative SFC/PDA/ELSD System

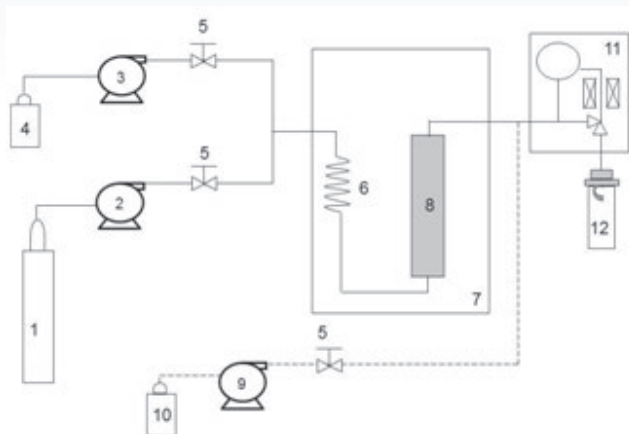

- | | |
|---------------------------------|-------------------------------------|
| 1. CO ₂ Cylinder | 7. CO-2060 Extraction Oven |
| 2. PU-2080-CO ₂ Pump | 8. EV-2 Extraction Vessel |
| 3. PU-2085 Modifier Pump | 9. PU-2080 Make-up Pump |
| 4. Modifier Solvent | 10. Make-up Solvent |
| 5. SV-500 Stop Valve | 11. BP-2080 Back Pressure Regulator |
| 6. Preheater Coil | 12. MCS-1 Micro Cyclone Separator |

Figure 5. Flow diagram of the JASCO SFE System

Results and Discussion

Firstly, the parameters for the gas flow rate, evaporator temperature and nebulizer temperature were optimized for SFC. These parameters are specific to the ELSD when used with SFC. Ethylparaben (Figure 6) and caffeine (Figure 7) were used as standard samples.

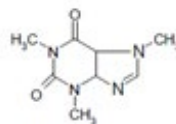
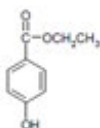

Figure 8 shows the chromatograms of Ethylparaben and caffeine when the gas flow rate is varied. Figure 9 shows the effect of gas flow rate on the peak areas for Ethylparaben and caffeine. The peak areas for Ethylparaben and caffeine were decreased as the nebulizer gas flow rate increased.

In the case of SFC, the mobile phase becomes gaseous CO₂ in the ELSD, and hence the gas flow rate is the total of CO₂ and nebulizer gas flow rates. For this reason, it is thought that the sensitivity becomes higher as the nebulizer gas flow rate is reduced.

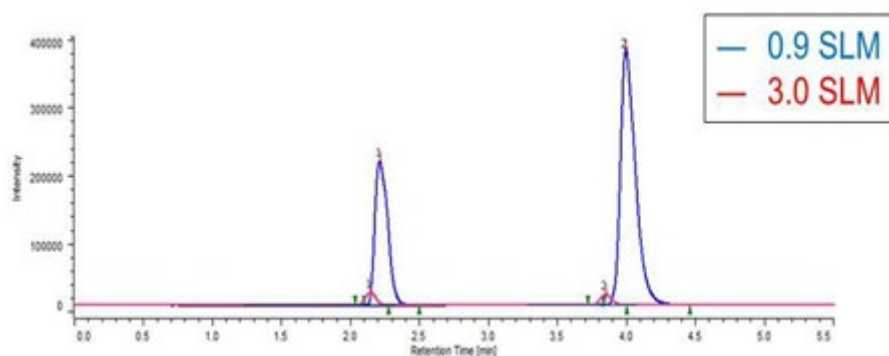

Figure 8. Chromatograms of Ethylparaben and Caffeine when the gas flow rate is varied.

Separation Conditions

Column:	SFCPak SIL-5 (4.6 mm ID x 250 mmL, 5 μm)
CO ₂ Flow Rate:	2 mL/min at -10°C
Modifier:	methanol @ flow rate 0.5 mL/min
Make Up Solvent:	methanol @ flow rate 0.5mL/min
Pressure:	20 MPa
Column Temperature:	40 °C
ELSD Evaporator Temperature:	40 °C
Nebulizer Temperature:	40 °C
Gas Flow:	0.9 and 3.0 SLM
Injection Volume:	5 μL
Splitter :	I.D. 50μm x 505 mm
Sample:	Ethylparaben and Caffeine (1mg/mL in MeOH.)

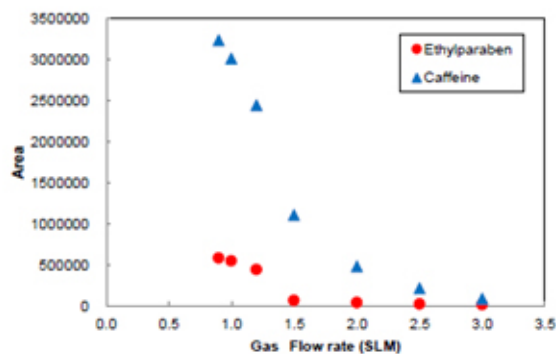

Figure 9. Effect of gas flow rate.

Separation Conditions

Column:	SFCPak SIL-5 (4.6 mm ID x 250 mmL, 5 μ m)
CO ₂ Flow Rate:	2 mL/min at -10°C;
Modifier:	methanol @ flow rate 0.5 mL/min
Make Up Solvent:	methanol @ flow rate 0.5mL/min
Pressure:	20 MPa
Column Temperature:	40 °C
ELSD Evaporator Temperature:	40 °C
Nebulizer Temperature:	40 °C
Gas Flow:	0.9, 1.0, 1.2, 1.5, 2.0, 2.5, 3.0 SLM
Injection Volume:	5 μ L
Splitter :	I.D. 50 μ m x 505 mm
Sample:	Ethylparaben and Caffeine (1mg/mL in MeOH.)

Figure 10 shows the chromatograms of Ethylparaben and caffeine when the evaporator temperature is varied. Figure 11 shows the effect of evaporator temperature on the peak areas for Ethylparaben and caffeine. The evaporator temperature is set according to the volatility of sample.

The peak area for Ethylparaben, which is a semi-volatile organic compound, was decreased as the temperature was increased. On the other hand, the area for caffeine, which has low volatility, was almost the same when the temperature was 30 °C or greater.

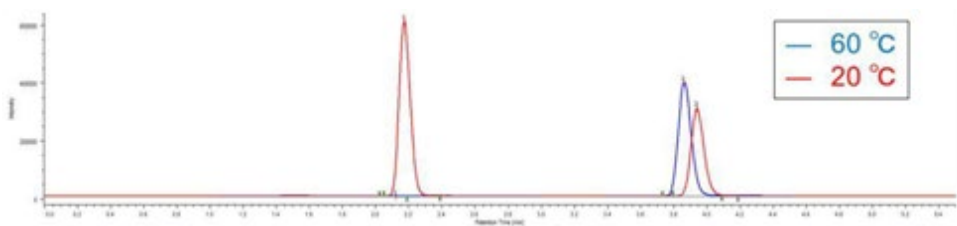

Figure 10. Chromatograms of Ethylparaben and Caffeine when the evaporator temperature is varied.

Separation Conditions

Column:	SFCPak SIL-5 (4.6 mm ID x 250 mmL, 5 μ m)
CO ₂ Flow Rate:	2 mL/min at -10°C;
Modifier:	methanol @ flow rate 0.5 mL/min
Make Up Solvent:	methanol @ flow rate 0.5mL/min
Pressure:	20 MPa
Column Temperature:	40 °C
ELSD Evaporator Temperature:	20, 60 °C
Nebulizer Temperature:	40 °C
Gas Flow:	0.9 SLM
Injection Volume:	5 μ L
Splitter :	I.D. 50 μ m x 505 mm
Sample:	Ethylparaben and Caffeine (1mg/mL in MeOH.)

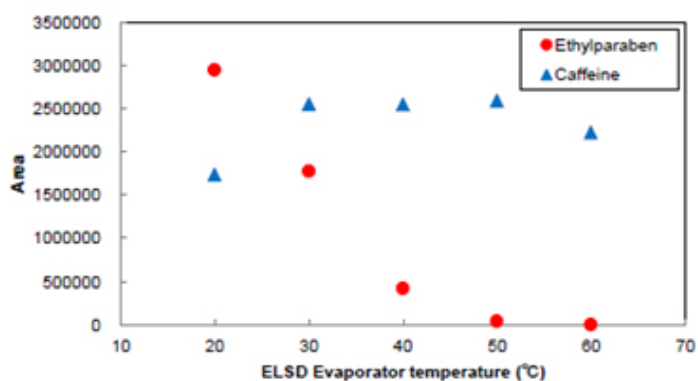

Figure 11. Effect of evaporator temperature.

Separation Conditions

Column:	SFCPak SIL-5 (4.6 mm ID x 250 mmL, 5 μm)
CO ₂ Flow Rate:	2 mL/min at -10°C;
Modifier:	methanol @ flow rate 0.5 mL/min
Make Up Solvent:	methanol @ flow rate 0.5mL/min
Pressure:	20 MPa
Column Temperature:	40 °C
ELSD Evaporator Temperature:	20, 30, 40, 50, 60 °C
Nebulizer Temperature:	40 °C
Gas Flow:	0.9 SLM
Injection Volume:	5 μL
Splitter :	I.D. 50μm x 505 mm
Sample:	Ethylparaben and Caffeine (1mg/mL in MeOH.)

Figure 12 shows the effect of nebulizer temperature on the peak areas for Ethylparaben and caffeine. The peak areas were not changed as the temperature was changed. This shows that the nebulizer temperature does not affect the peak areas for these samples.

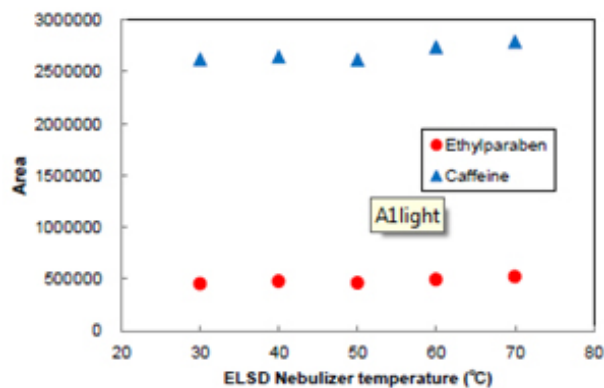

Figure 12. Effect of Nebulizer temperature.

Separation Conditions

Column:	SFCPak SIL-5 (4.6 mm ID x 250 mmL, 5 µm)
CO ₂ Flow Rate:	2 mL/min at -10°C;
Modifier:	methanol @ flow rate 0.5 mL/min
Make Up Solvent:	methanol @ flow rate 0.5mL/min
Pressure:	20 MPa
Column Temperature:	40 °C
ELSD Evaporator Temperature:	30, 40, 50, 60, 70 °C
Nebulizer Temperature:	40 °C
Gas Flow:	0.9 SLM
Injection Volume:	5 µL
Splitter :	I.D. 50µm x 505 mm
Sample:	Ethylparaben and Caffeine (1mg/mL in MeOH.)

When using an ELSD with SFC a splitter must be used as the total volume of CO₂ from the back pressure regulator would be too excessive for the detector.

A typical splitter is made from a capillary tube. A part of the sample stream is split by the capillary and introduced into the detector probe. The split ratio is controlled by the inner diameter and length of capillary tube. However, the split ratio varies with temperature, pressure and flow rate.

Figure 13 shows the effect of splitter length on the peak areas for Ethylparaben and caffeine. The peak area for caffeine became smaller as the length of the splitter was increased as the split ratio was reduced. Ethylparaben shows similar results to caffeine but if the capillary length is too short the CO₂ flow rate through the detector becomes too great and impacts on sensitivity

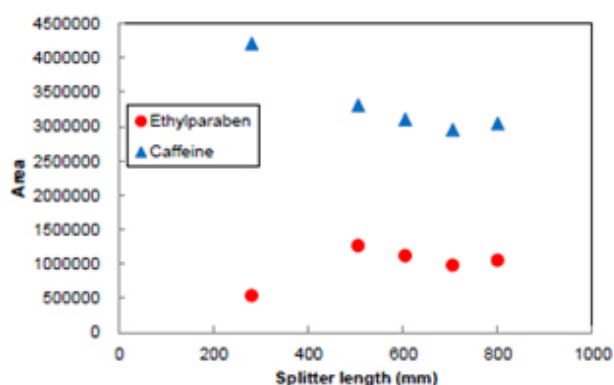

Figure 13. Effect of Splitter length

Separation Conditions

Column:	SFCPak SIL-5 (4.6 mm ID x 250 mmL, 5 µm)
CO ₂ Flow Rate:	2 mL/min at -10°C;
Modifier:	methanol @ flow rate 0.5 mL/min
Make Up Solvent:	methanol @ flow rate 0.5mL/min
Pressure:	20 MPa
Column Temperature:	40 °C
ELSD Evaporator Temperature:	30, 40, 50, 60, 70 °C
Nebulizer Temperature:	40 °C
Gas Flow:	0.9 SLM
Injection Volume:	5 µL
Splitter :	I.D. 50µm x 505 mm
Sample:	Ethylparaben and Caffeine (1mg/mL in MeOH.)

In the case of SFC, the solvent exhausted from the splitter outlet is an aerosol due to the CO₂. At this point the solubility of the sample drops, and there is increased risk of sample plugging the tube. Pumping a make-up flow solvent prior to the splitter can prevent blockage of the capillary and gives stable detection when measuring samples with a concentration, for example with preparative SFC.

Figure 14 shows the relationship between the peak area of Ethylparaben and caffeine and the variation in make-up pump flow rate. Without make-up solvent the sensitivity is reduced, but with a small make-up flow the sensitivity increases until a point where it starts to decrease, most likely caused by a dilution effect or poor evaporation due to too much liquid.

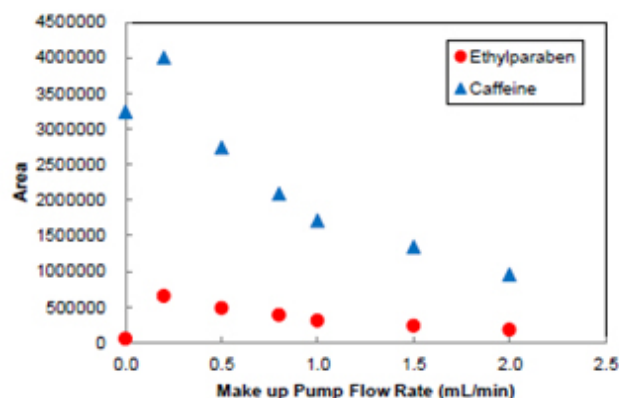

Figure 14. Effect of Splitter length

Separation Conditions

Column:	SFC Pak SIL-5 (4.6 mm ID x 250 mmL, 5 μm)
CO ₂ Flow Rate:	2 mL/min at -10°C;
Modifier:	methanol @ flow rate 0.5 mL/min
Make Up Solvent:	methanol @ flow rate 0, 0.2, 0.5, 0.8, 1.0, 1.5, 2.0 mL/min
Pressure:	20 MPa
Column Temperature:	40 °C
ELSD Evaporator Temperature:	30, 40, 50, 60, 70 °C
Nebulizer Temperature:	40 °C
Gas Flow:	0.9 SLM
Injection Volume:	5 μL
Splitter :	I.D. 50μm x 505 mm
Sample:	Ethylparaben and Caffeine (1mg/mL in MeOH.)

ELSD Parameters Summary

Nebulizer Gas Flow Rate

Low flow rate provides high sensitivity. Optimum gas flow rate is 0.8 – 1.0 SLM.

Evaporator Temperature

The evaporator temperature setting depends on the volatility of the sample. To detect samples with higher volatility the optimum evaporator temperature is 20-40 °C

Nebulizer Temperature

The nebulizer temperature does not effect on the sensitivity.

Splitter length

The sensitivity changes with the length of the splitter. However, the sensitivity decreased with increased CO2 flow rate. This is sample dependent.

Make up pump flow rate

Make-up solvent should be used and optimized for Preparative SFC/ELSD to prevent clogging of the tubing.

Purification of Parthenolide in Feverfew by SFE and SFC

SFE

Feverfew was extracted using the SFE system shown in Figure 4, referring to the Reference2. The SFE conditions are shown in Table I. The preparation after the extraction was shown in Figure 15.

Table 1. SFE Conditions

Sample	Feverfew 1.0g
Extraction Vessel	10mL, I.D. 10mm x 127mm
CO2 Flow Rate	3.0 mL/min
Make-up Solvent Flow Rate	0.3 mL/min (MeOH)
Temperature	45°C
Pressure	30MPa
Extraction Time	60 min

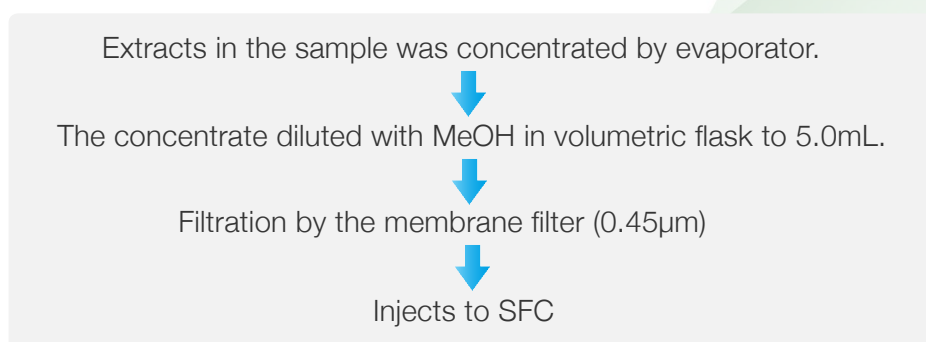

Figure 15. Sample Preparation Flow Chart

The Feverfew sample was extracted by SFE, pre-treated and then separated by semi preparative SFC, the Parthenolide was fractionated and collected. Figure 16 shows the semi-preparative separation of the Feverfew extract. The peak shown in the blue rectangle was collected as a fraction and analyzed and identified by analytical SFC. Figure 17 shows the analytical separation. By comparing the peak area with that for a standard sample of Parthenolide, we confirmed that 0.03mg/g of Parthenolide was collected.

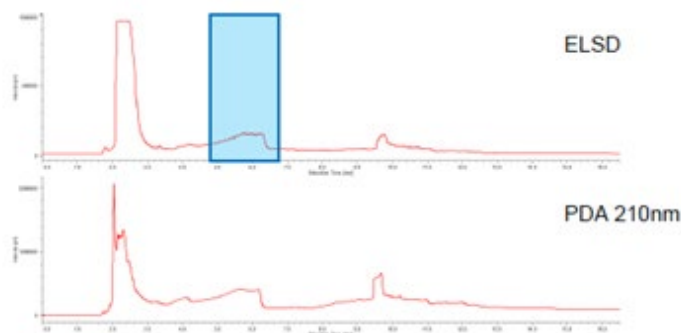

Figure 16. Chromatogram of the extract in Feverfew

Separation Conditions

Column:	SFCPak SIL-5SP (10 mm ID x 250 mmL, 5 μ m)
CO ₂ Flow Rate:	10 mL/min at -10°C
Modifier:	methanol @ flow rate 0.3, 0.73, 1.5 mL/min 0, 7.2, 7.3 min
Make Up Solvent:	methanol @ flow rate 0.5 mL/min;
Pressure:	20 MPa
Column Temperature:	40 °C
ELSD Evaporator Temperature:	40 °C
Nebulizer Temperature:	40 °C
Gas Flow:	0.9 SLM
Injection Volume:	5 μ L
Splitter :	I.D. 50 μ m x 505 mm
Sample:	The concentrated exact in Feverfew

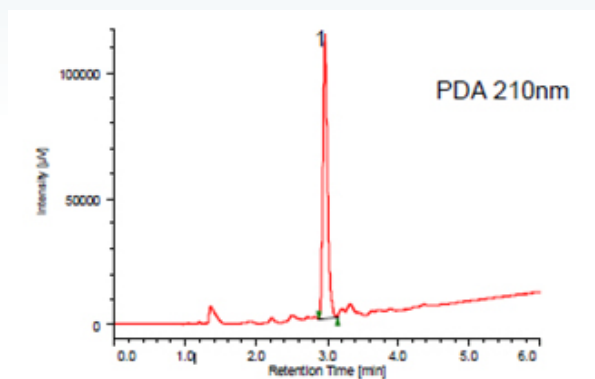

Figure 17. Chromatogram of the fraction.

Separation Conditions

Column:	SFCPak SIL-5 (4.6 mm ID x 250 mmL, 5 μ m)
CO ₂ Flow Rate:	3.0 mL/min at -10°C
Modifier:	methanol @ flow rate 0.2 0.38 mL/min 0 6.0 min
Pressure:	20 MPa
Column Temperature:	40 °C
Injection Volume:	5 μ L
Sample:	The fraction