

FTIR, NIR and UV-Vis Accessories and Supplies



SPECTROSCOPY IN MOTION

A special look at our automated accessories that are changing the world of sampling. Find them wherever you see our molecule in motion icon.

PIKE
TECHNOLOGIES

Sampling Kits
ATR
Diffuse Reflection
Specular Reflection
Polarizers
Integrating Spheres

Remote Sampling
Microsampling
Transmission
IR Windows
Special Applications
Standards and more!

WHO WE ARE

PIKE Technologies was established in 1989 by Phil and Irene Brierley with the goal of creating a unique enterprise specializing in the imaginative design and creation of high-quality custom spectroscopic accessories. They founded PIKE on the principle of making the life of the spectroscopist easier through replacing traditional, tedious sampling routines with a range of innovative products and techniques...all at an outstanding value!

Phil's knowledge of optics, mechanics, and software along with his honesty and dedication earned him great respect. His fun-loving nature, thoughtfulness and loyalty made him many friends. He influenced the FTIR industry with high-value accessories. Under his leadership, PIKE created a comprehensive line of sampling accessories including Attenuated Total

Reflection (ATR), diffuse and specular reflection, transmission cells, sample holders and automation. Phil passed away in 1999, but his legacy lives on.

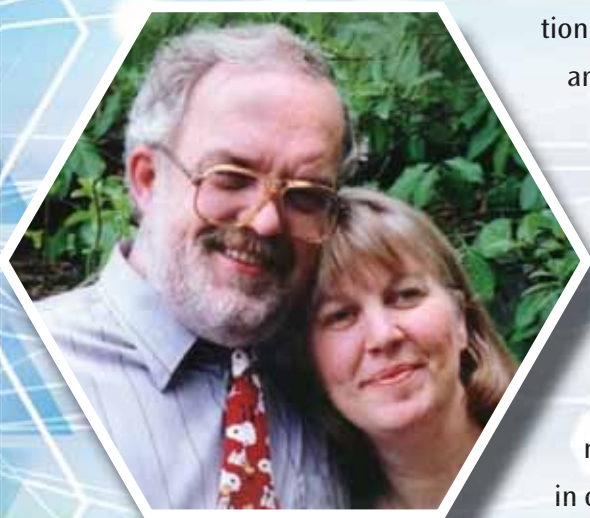

After 29 years, PIKE is proud to carry on Phil's vision and ideals. We are always looking for new ways to help make your spectroscopy sampling easier and more effective. We think you will see in our new products introduced each year that you, our customers, have helped us to achieve this goal.

If you do not see what you need in this catalog, please [contact us](#). Your input might become one of our product offerings in the future. We look forward to serving you with our products and support.

A unique enterprise specializing in the imaginative design and creation of excellent spectroscopic accessories, providing high-quality solutions to all customers.

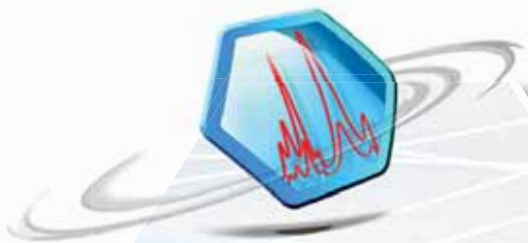

SPECTROSCOPY *IN MOTION*

For years, PIKE Technologies has been on the forefront in the development of compact and large-scale automated spectroscopic accessories. Our goal is to assist our customers in realizing the advantages of sampling automation in their labs. We specialize in the design and manufacture of custom, programmable products for use with commercial FTIR spectrometers and UV-Vis spectrophotometers.

[Contact us](#) to discuss your specific automation needs and applications.

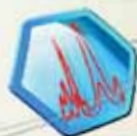

Throughout this special edition catalog, wherever you see our molecule in motion icon you will find an automated accessory. Click on video links to watch clips of select accessories in action!



AutoPRO, PIKE Technologies' control software, plays an integral role in the usability and value of automated accessories. Software features make AutoPRO exceptionally configurable for accommodating standard product and custom mapping profiles.

Data collection is enabled through communication with most FTIR software programs. AutoPRO allows for traceability by facilitating multiple users. For ease of file finding, the program offers numerous file naming schemes. It also incorporates options for calling macros.

To increase consistency, reduce set up time and minimize mistakes, AutoPRO profiles containing sampling and data collection protocols can be saved and recalled for future use.

EASE OF USE

- Intuitive graphical interfaces using toolbars and data grids
- Most operational parameters are concealed until needed
- Video tutorials for installation and operation
- Quick access to help with popup tool tips and video clips
- At-a-glance experiment status

FLEXIBLE REFERENCE COLLECTING

- Repeat background collection during the middle of an experiment
- Collect backgrounds at all points or at a single point
- Use an existing background file
- Choose not to collect a background

MACROS

- Create customizable experiments
- Library searching/peak picking
- Report generation
- Export results to spreadsheets

FLEXIBLE FILE NAMING

- Build spectral names from sample descriptions or time stamp
- Positional information saved with spectra

TABLE OF CONTENTS



Sampling Kits – A Great Place to Start

Products Overview	1
Premium Transmission Sampling Kit	2
Standard Transmission Sampling Kit	3
Comprehensive Transmission Sampling Kit	4
Educational Transmission Sampling Kit	5
Valu-Line Kit	6
Ultima Sampling Kit.....	7



Attenuated Total Reflectance – Liquids, Solids and In-Between

Products Overview	9
MIRacle – <i>Fast and Easy IR Sampling</i>	10
Dedicated MIRacle Sampling Tools	14
GladiATR – <i>Highest Performance Diamond ATR</i>	15
GladiATR Vision – <i>Diamond ATR with Sample View</i>	18
Dedicated GladiATR and GladiATR Vision Sampling Tools – <i>More Options to Address Your Specific Application Requirements</i>	20
Multiple Reflection HATR – <i>Maximum Sensitivity and Highly Versatile FTIR Sampling</i>	21
ATRMax II Variable Angle Horizontal ATR Accessory – <i>HATR for Inquisitive Minds</i>	26
VeeMAX III with ATR – <i>Variable Angle, Single Reflection ATR for Depth Profiling Studies</i>	29
AutoATR – <i>An Innovative Breakthrough in Automated ATR Sampling</i>	32
JetStream ATR Accessory – <i>Measurements of Liquids under Varying Conditions</i>	34
Classic VATR – <i>Variable Angle ATR for Analysis of Solids, Films and Coatings</i>	36
Theory and Applications	37



Diffuse Reflectance – From Powders to Plastic Bumpers

Products Overview	41
EasiDiff – <i>Workhorse Diffuse Reflectance Accessory</i>	42
DiffusIR – <i>Research Grade Diffuse Reflectance Accessory</i>	43
UpIR – <i>Upward Looking Diffuse Reflectance Accessory</i>	45
AutoDiff – <i>Automated Diffuse Reflectance Sampling</i>	46
XY Autosampler – <i>Transmission and Reflectance Automated Sampling in Microplate Format</i>	47
Sample Preparation and Loading Kit – <i>The Easiest Way to Work With Powder Samples</i>	48
Abrasion Sampling Kit.....	48
Theory and Applications	49

TABLE OF CONTENTS



Pages 51–60

Specular Reflectance – *Thin Films and More*

Products Overview	51
VeeMAX III – <i>The Ultimate Variable Angle Specular Reflectance Accessory</i>	50
10Spec – <i>Near-normal Sample Reflectivity Measurements</i>	52
30Spec and 45Spec – <i>Specular Reflectance for Thick Films</i>	53
80Spec – <i>Grazing Angle Specular Reflectance for Thin Films</i>	54
AGA – <i>Advanced Grazing Angle Specular Reflectance for Thin Films with Precise Spot Control</i>	55
Absolute Reflectance Accessory – <i>Measure Absolute Sample Reflectivity</i>	56
Theory and Applications	57



Pages 59–62

Polarization – *For Oriented Samples and Research Applications*

Products Overview	59
Polarizers – <i>Manual and Automated Versions for Molecular Spectroscopy</i>	60
Theory and Applications	61



Pages 63–70

Integrating Spheres – *Reflectance From All Perspectives*

Products Overview	63
Mid-IR IntegratIR – <i>Integrating Sphere</i>	64
External Integrating Sphere – <i>Precise Reflectivity Measurements</i>	66
NIR IntegratIR – <i>Integrating Sphere</i>	67
Introduction and Theory.....	69

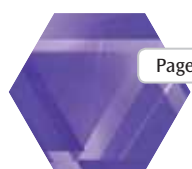

Pages 71–77

Remote Sampling Accessories – *Extending Your Sample Compartment*

Products Overview	71
Mid-IR FlexIR – <i>Hollow Waveguide Accessory for Remote Infrared Sampling</i>	72
NIR FlexIR – <i>NIR Fiber Optic Accessory for Fast and Remote Sample Identification</i>	75
Introduction and Applications	76



Pages 79–87

Microsampling Products – *From Microns to Millimeters*

Products Overview	79
μMAX – <i>Sample Compartment Microscope for FTIR</i>	80
Microsampling Tools – <i>Compression Cells and Sample Manipulation</i>	83
Micro Diamond Cell – <i>For Compressing and Holding Samples for Microanalysis</i>	84
Compact Transmission/Reflection S100 Microscope Heat Stage – <i>High Temp Measurements under Vacuum or Controlled Gas Flow</i>	85
Beam Condensers – <i>4X and 6X Versions for FTIR</i>	86



Transmission Sampling – Automated & Manual Technologies

Products Overview 91

Transmission Multi-SamplIR – *Automated In-Sample Compartment Accessory*..... 92

RotatIR – *Automated Rotating Sample Stage* 93

Automated Horizontal Transmission Accessories – *For Films or Pellets* 94

XY Autosampler –
Transmission and Reflection, Automated Sampling in Microplate Format 95

YZ Autosampler – *Automated Transmission Mapping Stage*..... 96

Liquid Samples

Press-On Demountable Cell – *For Viscous Liquids and Mulls* 97

Demountable Liquid Cells – *For Versatile Pathlength Liquid Sampling*..... 98

SmartSeal Liquid Cells – *For Precision, Fixed Pathlength Liquid Sampling*..... 99

Long-Path Quartz Liquid Cells –
For Analysis of Hydrocarbon Content and Related Measurements 100

Falcon Mid-IR Transmission Accessory –
For Precise Temperature Control of Demountable Liquid Cells 101

Falcon NIR Transmission Accessory – *Quantitative and Qualitative
 Analysis of Liquids under Precise Temperature Control* 103

Solid Samples

Heated Solid Transmission Accessory –
Measurements of Optical Components and Polymers 104

Bolt Press & Hydraulic Die – *Low-Cost Pellet Preparation*..... 105

Hand Press – *For Making Smaller Pellets* 105

Evacuable Pellet Press – *For Preparation of High Quality Pellets* 106

Pixie – *Manual Hydraulic Press*..... 107

CrushIR – *Digital Hydraulic Press*..... 108

PressPRO – *Programmable Hydraulic Press* 109

Heated Platens Accessory – *For Making Thin Films of Polymeric Samples*..... 110

ShakIR and Super ShakIR – *For Optimized Sample Mixing*..... 111

Sample Preparation Accessories – *For Solid Material Analysis*..... 112

Optical and Sampling Components, Polishing Kits

Sample Holders – *For Transmission FTIR Analysis of Pellets and Films*..... 113

Disks, Windows and Powders – *For Transmission FTIR Analysis* 114

Crystal Polishing Kit – *Extending the Life of IR Transparent Windows* 117

Gas Samples

Short-Path Gas Cells – *For Samples with Higher Vapor Phase Concentration*..... 118

Heated Gas Flow Cell – *For Streaming Gas Analysis* 119

Low-Volume Heated Gas Cell –
Near-Instantaneous Feedback on Compositional Changes 120

Stainless Steel Short-Path Gas Cells –
For Measuring High Concentration Vapor Components 121

Long-Path Gas Cells – *For Measuring Low Concentration Vapor Components* 123

Theory and Applications 126

TABLE OF CONTENTS



Special Applications

Products Overview	129
Vertical Wafer Accessory – <i>For Analysis of Semiconductor Wafers</i>	130
MappIR and MAP300 – <i>For Automated Analysis of Semiconductor Wafers</i>	131
TGA/FTIR Accessory – <i>Identification and Quantification of Evolved Gases from Thermogravimetric Analyzer</i>	133
GC-FTIR Accessory – <i>Combining GC Separation with Identification Power of FTIR</i>	135
External Sample Module – <i>Extending Sampling Efficiency</i>	136
Semiconductor Applications – <i>FTIR Sampling Techniques Overview</i>	137



UV-Vis Accessories

Products Overview	139
UV-Vis Cuvettes, Cells, Vials and Holders	140
Peltier-Controlled Cuvette Holders for UV-Vis Spectrophotometers – <i>Experiments Under Tightly Controlled Temperature Conditions</i>	142
Falcon UV-VIS – <i>Precise Cell Temperature Control Accessory</i>	144
UV-Vis DiffusIR – <i>Diffuse Reflectance Accessory</i>	145
UV-Vis Polarizers – <i>Manual and Automated Versions</i>	147
UV-Vis Nanowire Grid Polarizers – <i>Manual and Automated Versions</i>	148
UV-Vis Spec – <i>Slide Mounted Specular Reflectance Accessories</i>	149
UV-Vis 10Spec – <i>For Near Normal Reflectivity Measurements</i>	150
UV-VIS 85Spec – <i>Specular Reflectance Accessory</i>	151
UV-Vis VeeMAX – <i>Variable Angle Specular Reflectance Accessory</i>	152
Out-of-Compartment Microplate Reader – <i>Plate Reading Option for UV-Vis Spectrophotometers</i>	153
Automated XY, R-Theta and Y-rotation Stages – <i>For UV-Vis Spectrophotometers</i>	154



Standards, Software and Databases

Products Overview	155
Reference Standards – <i>For Calibrating FTIR Spectrometers</i>	156
PIKECalc Software – <i>For FTIR Sampling Computations</i>	159
ATR Spectral Databases – <i>Optimize Search Results for ATR Spectral Data</i>	160
Transmission Spectral Databases – <i>High-Quality Spectral Data for Optimized Search Results</i>	161
Catalog Index – <i>Alphabetical</i>	163
FTIR and UV-Vis Instrument Codes.....	164
Order Terms, Contact Information, Guarantee.....	165

SAMPLING KITS

If you are not sure where to start, check out PIKE Technologies' sampling kits. You will immediately find everything you need for the most basic FTIR experiments, and you will be able to collect your first spectrum in less than 30 minutes from the time the kit arrives.

The kits are carefully designed to include all necessary components. They eliminate guesswork and assure that you have everything you need for immediate productivity.

Premium Transmission Sampling Kit Page 2
Complete kit for transmission FTIR sampling including the Pixie hydraulic pellet press

Standard Transmission Sampling Kit Page 3
Everything you need to run liquid and solid samples by transmission IR spectroscopy

Comprehensive Transmission Sampling Kit Page 4
Complete gas, liquid and solid sampling

Educational Transmission Sampling Kit Page 5
An economical assembly of FTIR sampling tools for transmission sampling

Valu-Line Kit Page 6
High-performance set of modern FTIR accessories addressing all solid and liquid sampling needs

Ultima Sampling Kit Page 7
Highest-performance, single reflection ATR and back-up accessories to do it all!

Premium Transmission Sampling Kit – *All the Tools for Easy Preparation of Transmission Measurements of Liquids and Solids*



FEATURES

- Complete kit for transmission FTIR sampling
- Pixie small hydraulic press for making KBr pellets
- Making mulls for solid samples
- Run liquid samples for qualitative and quantitative analysis

The Premium Transmission Sampling Kit is a general purpose kit containing tools and materials for liquid and solid sampling. A demountable cell (drilled and undrilled windows with precision Teflon® spacers, plus 2" x 3" standard cell holder) is provided for measurements of liquid samples. Viscous liquids can be measured directly as a thin film between the KBr windows. The kit includes Pixie, a small bench top hydraulic press, for the easy preparation of 7-mm KBr pellets. A mortar with pestle and Nujol™/Fluorolube® are provided for mull making – another popular method for preparation of solid samples. In addition, the kit contains a set of the most popular sample holders including the universal holder for polymer films, KBr pellet holder and PIKE disposable/storage cardboard cards for pellets and polymer films. For a complete product listing, please refer to the table below.

ORDERING INFORMATION

PART NUMBER	DESCRIPTION
162-1010	Premium Transmission Sampling Kit <i>Includes Pixie hydraulic pellet press, sample preparation tools, mull liquids, cells, windows and cell holders required for preparation and analysis of solid and liquid samples</i>

INCLUDED PARTS AND MATERIALS

PART NUMBER	DESCRIPTION
160-8010	KBr Powder, 100 g
161-0510	Fluorolube, 1 oz
161-0500	Nujol, 1 oz
042-3035	Spatula, spoon
042-3050	Spatula, flat
161-5030	Mortar and Pestle, 35 mm
181-1400	Pixie Hydraulic Pellet Press
161-1010	7-mm Die Set
161-1011	7-mm Collar
161-1018	KBr Pellet Holder
161-6000	Finger Cots (12 ea.)
162-1100	Demountable Liquid Cell Assembly
160-1010	Window, KBr, 32 x 3 mm (6 ea.)
160-1015	Window, KBr, 32 x 3 mm, drilled (6 ea.)
162-1290	Teflon Spacers, assortment
161-0521	Syringe, 2 mL (2 ea. in kit)
162-3610	Press-On Demountable Liquid Cell Holder for 32-mm windows
162-5600	Universal Sample Holder*
162-5300	Magnetic Film Holder for 13-mm pellets and film samples
162-5400	Film Sampling Card, 20-mm clear aperture (10 ea.)*

* Note: Cell holders marked "*" fit all standard slide mounts, but due to their height may not allow for a complete sample compartment door closure on some smaller spectrometers. Please consult PIKE Technologies before placing an order.

Standard Transmission Sampling Kit – *Everything You Need to Run Liquid and Solid Samples by Transmission IR Spectroscopy*



This general purpose kit contains tools and materials for liquid and solid sampling. A demountable cell (drilled and undrilled windows with precision Teflon™ spacers, plus 2" x 3" standard cell holder) is provided for measurements of liquid samples. Viscous liquids can be measured directly as a thin film between the KBr windows. The kit includes a hand-operated press for the preparation of 7-mm KBr pellets. A mortar with pestle and Nujol™/Fluorolube® are provided for mull making – another popular method for preparation of solid samples. In addition, the kit contains a set of the most popular sample holders including a universal holder for polymer films, a KBr pellet holder and PIKE disposable/storage cardboard cards for pellets and polymer films. For a complete product listing, please refer to the table below.

ORDERING INFORMATION

PART NUMBER	DESCRIPTION
162-1000	Standard Transmission Sampling Kit <i>Includes sample preparation tools, mull liquids, cells, windows and cell holders required for preparation and analysis of solid and liquid samples</i>

INCLUDED PARTS AND MATERIALS

PART NUMBER	DESCRIPTION
160-8010	KBr Powder, 100 g
161-0510	Fluorolube, 1 oz
161-0500	Nujol, 1 oz
042-3035	Spatula, spoon
042-3050	Spatula, flat
161-5035	Mortar and Pestle, 35 mm
161-1027	PIKE Hand Press for KBr pellets
161-1010	7-mm Die Set
161-1018	KBr Pellet Holder
161-6000	Finger Cots (12 ea.)
162-1100	Demountable Liquid Cell Assembly
160-1010	Window, KBr, 32 x 3 mm (6 ea.)
160-1015	Window, KBr, 32 x 3 mm, drilled (6 ea.)
162-1290	Teflon Spacers, assortment
161-0521	Syringe, 2 mL (2 ea. in kit)
162-3610	Press-On Demountable Liquid Cell Holder for 32-mm windows
162-5600	Universal Sample Holder*
162-5300	Magnetic Film Holder for 13-mm pellets and film samples
162-5400	Film Sampling Card, 20-mm clear aperture (10 ea.)*

* Note: Cell holders marked "*" fit all standard slide mounts, but due to their height may not allow for a complete sample compartment door closure on some smaller spectrometers. Please consult PIKE Technologies before placing an order.

FEATURES

- Complete kit for transmission FTIR sampling
- Make KBr pellets and mulls for solid samples
- Run liquid samples for qualitative and quantitative analysis
- Convenient padded carrying and storage case

Comprehensive Transmission Sampling Kit – Complete Gas, Liquid and Solid Sampling



FEATURES

- Complete sampling kit for analysis of solids, liquids and gas samples by transmission
- Make KBr pellets and mulls for solid samples
- Run qualitative and quantitative analysis of liquid samples
- Identify and quantify gas samples
- Convenient padded carrying and storage case

The Comprehensive Transmission Sampling Kit includes a 100-mm pathlength, 38-mm diameter gas cell, in addition to all the sample preparation and mounting tools described in the Standard Transmission Sampling Kit on the previous page. The gas cell body is made of Pyrex® glass and features straight-tube inlet and outlet ports with stopcocks. The gas cell comes with all necessary gaskets, two KBr windows and slide-mounted cell holder, and is designed for gas measurements at ambient temperature and normal atmospheric pressure.

ORDERING INFORMATION

PART NUMBER	DESCRIPTION
162-2000	Comprehensive Transmission Sampling Kit <i>Includes sample preparation tools, mull liquids, cells, windows and cell holders required for preparation and analysis of gas, solid and liquid samples</i>

INCLUDED PARTS AND MATERIALS

PART NUMBER	DESCRIPTION
160-8010	KBr Powder, 100 g
161-0510	Fluorolube®, 1 oz
161-0500	Nujol™, 1 oz
042-3035	Spatula, spoon
042-3050	Spatula, flat
161-5035	Mortar and Pestle, 35 mm
161-1027	PIKE Hand Press for KBr pellets
161-1010	7-mm Die Set
161-1018	KBr Pellet Holder
161-6000	Finger Cots (12 ea.)
162-5300	Magnetic Film Holder for 13-mm pellets and film samples
162-1100	Demountable Liquid Cell Assembly
160-1010	KBr Window, 32 x 3 mm (6 ea.)
160-1015	KBr Window, 32 x 3 mm, drilled (6 ea.)
162-1290	Teflon® Spacers, assortment
161-0521	Syringe, 2 mL (2 ea. in kit)
162-3610	Press-On Demountable Liquid Cell Holder for 32-mm windows
162-5600	Universal Sample Holder*
162-2200	Gas Cell, 100-mm pathlength, 38-mm diameter
160-1320	Window, KBr, 38 x 6 mm (2 ea. in kit)
162-5400	Film Sampling Card, 20-mm clear aperture (10 ea.)*

Note: Cell holders marked "" fit all standard slide mounts, but due to their height may not allow for a complete sample compartment door closure on some smaller spectrometers. Please consult PIKE Technologies before placing an order.

Educational Transmission Sampling Kit – An Economical Assembly of Sampling Tools



The Educational Sampling Kit contains all necessary tools for the analysis of gas, liquid and solid samples. It was designed as a low-cost alternative for busy teaching laboratories. The kit offers a 100 mm x 25 mm gas cell with straight, septa protected tubes, a bolt press for making KBr pellets and a 35-mm mortar and pestle. Please refer to the table below for the detailed list of all components.

ORDERING INFORMATION

PART NUMBER	DESCRIPTION
162-3000	Educational Transmission Sampling Kit <i>Includes sample preparation tools, mull liquids, cells, windows and cell holders required for preparation and analysis of gas, solid and liquid samples</i>

INCLUDED PARTS AND MATERIALS

PART NUMBER	DESCRIPTION
160-8010	KBr Powder, 100 g
162-1100	Demountable Liquid Cell Assembly
161-0510	Fluorolube®, 1 oz
161-0500	Nujol™, 1 oz
160-1010	Window, KBr, 32 x 3 mm (6 ea.)
160-1015	Window, KBr, 32 x 3 mm, drilled (6 ea.)
042-3035	Spatula, spoon
042-3050	Spatula, flat
162-1290	Teflon® Spacers, assortment
161-0521	Syringe, 2 mL (2 ea. in kit)
161-5035	Mortar and Pestle, 35 mm
162-3610	Press-On Demountable Liquid Cell Holder for 32-mm windows
161-2500	Bolt Press for KBr pellets
161-2511	Wrench Set for bolt press (2 ea.)
162-2100	Gas Cell, 100-mm pathlength, 25-mm diameter
160-1133	Window, KBr, 25 x 4 mm (2 ea. in kit)
161-6000	Finger Cots (12 ea.)
162-5300	Magnetic Film Holder for 13-mm pellets and film samples
162-5400	Film Sampling Card, 20-mm clear aperture (10 ea.)*

* Note: Cell holders marked "*" fit all standard slide mounts, but due to their height may not allow for a complete sample compartment door closure on some smaller spectrometers. Please consult PIKE Technologies before placing an order.

FEATURES

- Basic sampling kit for transmission FTIR sampling
- Perform qualitative and quantitative analysis
- Economical analysis of solids, liquids and gases
- Convenient padded carrying and storage case

Valu-Line Kit – High-Performance Set of FTIR Accessories Addressing All Solid and Liquid Sampling Needs



FEATURES

- Combination of most widely used FTIR accessories:
 - Multiple Reflection Horizontal ATR
 - Diffuse Reflection
 - 30-Degree Specular Reflection
- Full range of sampling options and applications
- Complete set of auxiliary sample preparation tools for immediate productivity
- Pre-aligned, fixed-position optical designs offering reproducible, high-quality data
- High-performance accessories providing excellent sampling sensitivity
- Economical and logical addition to any FTIR spectrometer.
- Excellent starter kit for routine applications, research or teaching

The number of available FTIR accessories can be overwhelming. Sometimes, it is not easy to decide which accessory will do the job. An answer to this problem is PIKE Technologies' Valu-Line Accessory Kit. This kit, packaged in a durable and convenient storage case, combines the most often used and practical set of FTIR sampling accessories. It includes the following components:

HATR – Multiple Reflection Horizontal ATR

Designed to analyze liquid and semi-liquid samples, pastes, gels, films, soft powders and multiple solid materials. This accessory comes with trough and flat crystal plates to accommodate all types of samples. The HATR is carefully designed to provide excellent results with minimum effort. It can be easily placed in the sample compartment and locked into position on the sample compartment baseplate, or a standard slide holder.

EasiDiff – Diffuse Reflection Accessory

An ideal accessory for the analysis of powders and intractable solids. With a set of convenient tools for solid sample preparation, this compact, high-performance accessory provides outstanding collection efficiency.

30Spec – Specular Reflection Accessory

A great accessory for the analysis of thin organic films deposited on reflective surfaces and a myriad of surface coatings and surface treatments. The 30Spec is slide-mounted and comes with a set of three masks which allow for the isolation of small, predetermined spots on larger samples, and the analysis of small samples.

Please refer to the appropriate sections of the catalog for additional details about these accessories.

ORDERING INFORMATION

PART NUMBER	DESCRIPTION
050-10XX	Valu-Line Kit Includes: HATR – combined trough and flat plate system, including 45-degree ZnSe crystal trough and flat plate, volatiles cover, powder press and sample clamp EasiDiff – diffuse reflection accessory with two micro and two macro sample cups, EasiPrep sample preparation kit, alignment mirror, mortar and pestle, and KBr 30Spec – specular reflection accessory with set of three masks for control of sampling spot size

Notes: Replace XX with your spectrometer's Instrument Code. [Click for List >](#)
Add -GE, -KR, -SI or -AM to the part number to substitute the following HATR crystal plates: Germanium, KRS-5, Silicon or AMTIR.

Ultima Sampling Kit – Highest-Performance, Single Reflection ATR and Backup Accessories to Do it All



FEATURES

- Complete kit for ATR, diffuse reflection, and specular reflection sampling techniques
- High-performance accessories eliminate tedious pellet making
- Analysis of liquids, solids, powders, polymers and thin film samples

In recent years, single reflection ATR measurements have become quite popular for two main reasons – they simplify sample preparation and reduce the complexity of traditional FTIR measurements. This is achieved through the reduction of the sampling area (smaller sample volume/size requirement), ease of cleaning and the introduction of more rigid, diamond-protected sampling interface, capable of withstanding higher pressures and harder samples. The single reflection ATR is capable of analyzing a wide variety of samples – including rigid solids and hard powders – which are difficult to achieve with a multi-reflection ATR. For these reasons, the single reflection ATR has gained the reputation of being a universal sampling device.

Other samples still need to be analyzed by other methods, especially when dealing with poor absorbers, some powders and films. For this reason, PIKE designed an accessory kit built around the MIRacle – Single Reflection ATR, and also included basic diffuse and specular reflection accessories. This combination offers a complete range of sampling devices used in FTIR and covers a wide variety of sampling needs. The Ultima Sampling Kit contains the following accessories:

MIRacle – Single Reflection ATR

Designed to analyze a wide variety of solid and liquid samples. It offers a number of unique features including a universal sampling plate which accommodates liquids, solids and powders, a small sampling interface (1.8 mm) making the analysis of small and/or awkward samples easy, and interchangeable sampling plates. All the above options allow for the best selection of an appropriate spectral range, and a configuration which matches the optical, physical and chemical properties of analyzed samples. The patented optical design of the accessory offers the highest energy throughput and maximum sensitivity. The MIRacle in this kit is equipped with a pressure clamp and purge attachments.

EasiDiff – Diffuse Reflection Accessory

An ideal product for the analysis of powders and intractable solids. With a set of convenient tools for sample preparation, this compact, high-performance accessory provides outstanding collection efficiency.

30Spec – Specular Reflection Accessory

A great accessory for the analysis of thin organic films deposited on reflective surfaces and a myriad of surface coatings and surface treatments. The 30Spec is slide-mounted and comes with a set of three masks which allow for the isolation of small, predetermined spots on larger samples, and the analysis of small samples.

Please refer to the appropriate sections of the catalog to review the theory and detailed descriptions of kit components.

ORDERING INFORMATION

PART NUMBER	DESCRIPTION
050-20XX	Ultima Sampling Kit Includes: MIRacle – single reflection ATR with ZnSe crystal, universal configuration for solid and liquid analysis, and high-pressure clamp EasiDiff – diffuse reflection accessory with sampling tools, two micro and two macro sample cups, EasiPrep sample preparation kit, alignment mirror, mortar and pestle, and KBr 30Spec – specular reflection accessory with set of three masks for control of sampling spot size
050-20XX-DI	Ultima Sampling Kit with Diamond ATR Includes: MIRacle – single reflection ATR with diamond/ZnSe crystal, universal configuration for solid and liquid analysis, and high-pressure clamp EasiDiff – diffuse reflection accessory with sampling tools, two micro and two macro sample cups, EasiPrep sample preparation kit, alignment mirror, mortar and pestle, and KBr 30Spec – specular reflection accessory with set of three masks for control of sampling spot size

Notes: Replace XX with your spectrometer's Instrument Code. [Click for List >](#)
Add -GE or -SI to part number 050-20XX to substitute Germanium or Silicon MIRacle crystal plates.

ATTENUATED TOTAL REFLECTION

ATR products successfully replace constant-path transmission cells and salt plates used for analysis of liquid and semi-liquid materials. Horizontal ATR accessories are used to analyze films, pastes, solids and fine powders. Thanks to the reproducible effective pathlength, ATR is well suited for both qualitative and quantitative applications. Several temperature control options are available.

MIRacle™ [Page 10](#)
Single Reflection ATR
Ideal for sample identification

GladiATR™ [Page 15](#)
Monolithic Diamond Single Reflection ATR
For intractable samples and temperature studies

GladiATR™ Vision [Page 18](#)
Monolithic Diamond ATR with Sample Viewing
Easy positioning and analysis of intractable samples

HATR [Page 21](#)
Multi-Reflection ATR
Highest sensitivity for minor components

ATRMax™ II [Page 26](#)
Variable Angle, Multi-Reflection ATR
Research-grade ATR

VeeMAX™ III ATR [Page 29](#)
Variable Angle, Single Reflection ATR
For depth profiling studies and monolayers

AutoATR [Page 32](#)
12 and 24-well Automated ATR Accessory
For large-scale studies and routine measurements

JetStream ATR [Page 34](#)
Cylindrical Crystal ATR
For measurement of liquids under varying conditions

VATR™ [Page 36](#)
Classic Variable Angle ATR

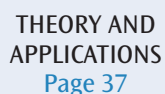

THEORY AND
APPLICATIONS
[Page 37](#)

MIRacle ATR – Fast and Easy IR Sampling



FEATURES

- Highest IR throughput – saving you time and improving your analysis quality
- Complete flexibility – add options to your MIRacle as your sampling needs change
- Highest value – for today's competitive analytical and research needs
- Fully configurable – diamond, ZnSe, Ge and Si MIRacle crystal plates; single or multiple reflections
- Pinned-in-place, changeable crystal plates – for fast and easy sampling optimization
- Highest purity, type IIa diamond crystal – will not scratch and is chemically inert to acidic or caustic materials
- Optional specular reflectance plate – for measurement of coatings on reflective surfaces
- Choice of pressure clamps – high-pressure, digital high-pressure and micrometric sample clamps
- Sampling options – temperature control, flow-through attachment and sealed clamp

%Throughput

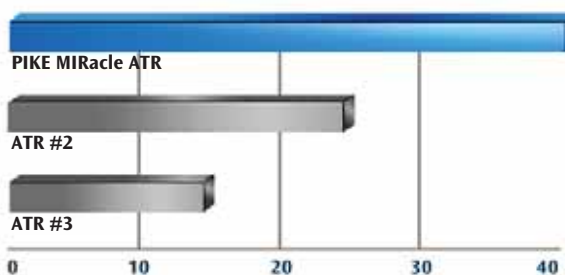

MIRacle – Highest IR Throughput ATR.

The PIKE MIRacle™ is a universal ATR sampling accessory for analysis of solids, liquids, pastes, gels, and intractable materials. In its most popular configuration it is a single reflection ATR accessory with high IR throughput which makes it ideal for sample identification and QA/QC applications. Easily changeable crystal plate design provides analysis of a broad spectrum of sample types while ensuring constant sampling pathlength. An assortment of crystal materials and single, three and nine reflection ATR crystals are available to optimize general qualitative or quantitative analysis.

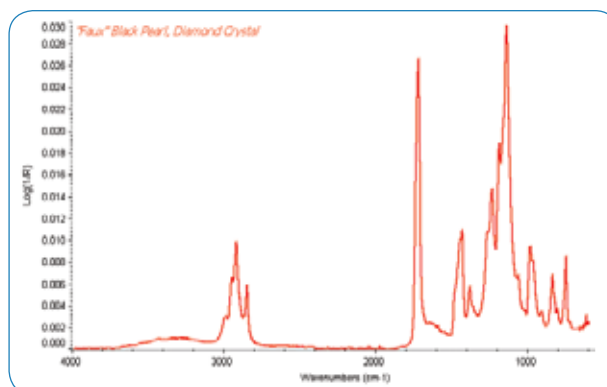

Faux black pearl, using MIRacle diamond ATR crystal.

MIRacle Optical Design

In the patented MIRacle optical design the ATR crystal focuses the IR beam and also provides the ATR sampling interface. This technology delivers greater energy throughput than competitive products, saves considerable time and produces higher quality spectra. For the single reflection, the small sampling surface results in increased force per unit area for improved contact between rigid samples and the ATR crystal.

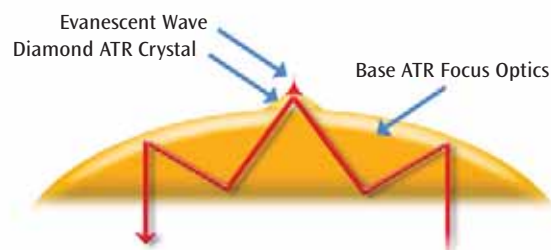

Beam path through MIRacle crystal optic.



MIRacle crystal plates. Clockwise: diamond/ZnSe, diamond/KRS-5, Ge, ZnSe and Si.

MIRacle Crystal Options

The MIRacle ATR accessory may be configured with five different crystal types: diamond/ZnSe, diamond/KRS-5, ZnSe, Ge and Si. 1-, 3- and 9-reflection styles are available. Trough and flat plate configurations are options for the multiple reflection plates.

Crystal plates are pinned in place and easily changeable within seconds with no alignment required. With this flexibility, you can change the crystal type to exactly match your sampling requirements. For example, diamond is ideal for brittle samples because it will not scratch, whereas Ge is ideal for carbon-filled samples because of its high refractive index and lower depth of penetration. Two single reflection diamond crystal plates are available, diamond/ZnSe and diamond/KRS-5. The latter offers a full spectral range to 250 cm^{-1} . 3- and 9-reflection crystal plates provide increased sensitivity for minor components in liquid samples. 3-reflection diamond/ZnSe crystal plates are available in flat and trough style, and 9-reflection diamond/ZnSe is offered in trough style only.



9-reflection trough plate, 3-reflection flat plate, specular reflectance plate

Table 1 shows MIRacle ATR crystal characteristics including refractive index, spectral range cutoff, pH range and hardness for single reflection ATR crystal plates. Still have questions? Please contact us as we are pleased to discuss your sampling requirements.

TABLE 1: MIRACLE CRYSTAL PLATE SPECIFICATIONS

MIRacle Crystal Plate	Application	Hardness kg/mm^2	Cutoff cm^{-1} , Spectral Range	Refractive Index @ 1000 cm^{-1}	Depth of Penetration @ 45°, μ	pH Range of Sample
Diamond/ZnSe	Ideal for hard samples, acids or alkaline	5700	525	2.4	2.00	1–14
Diamond/KRS-5	When you need full mid-IR spectral range	5700	250	2.4	2.00	1–14
Ge	General purpose and carbon filled or rubber	550	575	4.0	0.66	1–14
Si	Excellent for far-IR spectral measurement	1150	8900–1500, 475–40	3.4	0.85	1–12
ZnSe	General purpose ATR crystal	120	520	2.4	2.00	5–9

MIRacle crystal plates are covered by PIKE Technologies patent numbers 5,965,889 and 6,128,075 or are manufactured under license of 5,200,609, 5,552,604 and 5,703,366.

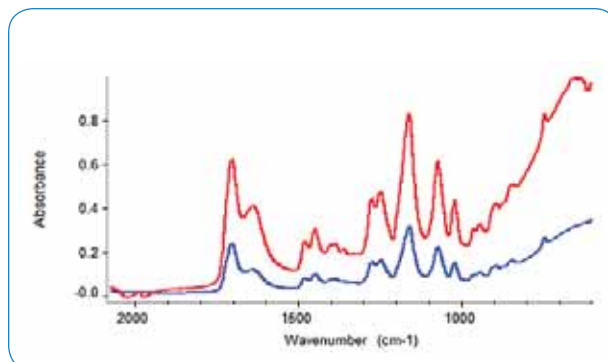

Hydrogel, using three reflection diamond/ZnSe crystal (red) and single reflection diamond/ZnSe (blue).

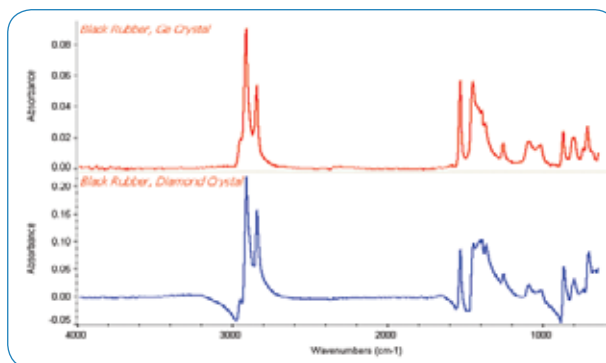

Black rubber samples are best run using Ge ATR crystal.

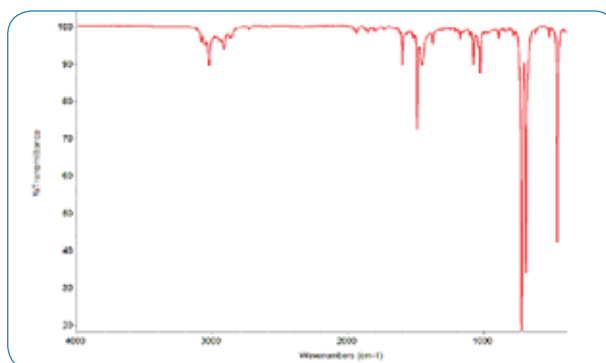

Toluene sample collected using diamond/KRS-5 crystal.



MIRacle Digital Clamp – ideal for controlled pressure



MIRacle Confined Space Clamp – for instruments with limited area in sample compartment



MIRacle High-Pressure Clamp – ideal for routine sampling



MIRacle Micrometer Clamp – for low pressure applications

MIRacle Pressure Clamp Options

MIRacle pressure clamps are pinned in place and easily changeable within seconds. A high-pressure clamp is recommended for most applications and is available in basic and digital configurations. The digital version requires a high-pressure clamp and the Digital Force Adapter (DFA) that attaches directly to the clamping assembly. The DFA's embedded load cell exhibits high linearity, reproducibility, and exceptional accuracy. The magnitude of applied force is displayed on an external easy-to-read LCD readout. The digital clamp is ideal for applications that require controlled and reproducible pressure. All clamps include tips for hard, soft and pellet-shaped samples. High-pressure clamps are calibrated to deliver over 10,000 psi of pressure when used with the single reflection crystal plates, and utilize a slip-clutch mechanism to prevent excessive pressure from being applied to the crystal.

Ability to deliver high pressure is very important for achieving spectral quality. In the example to the right, we demonstrate spectral differences of a porous polymer sample measured with the micrometer clamp and the high-pressure clamp. Clearly the high-pressure clamp is required to obtain a high-quality spectrum.

MIRacle Clamp Pressures	Max Force, lbs	Crystal Diameter, mm	Pressure, psi
High-Pressure Clamps	40	1.8	10,141
		6.0	913
Micrometer Pressure Clamp	8	1.8	2,028
		6.0	183

Note: All clamps except Micrometer are high-pressure.

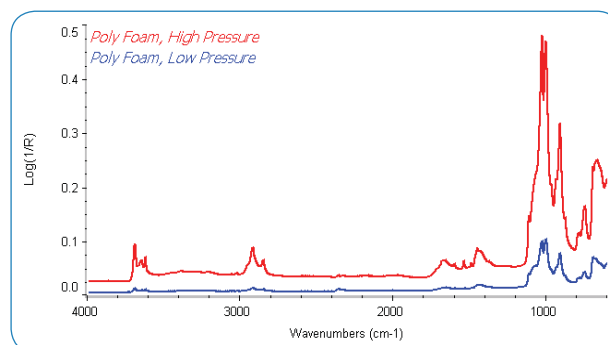

Porous polymer sample measured using high- and low-pressure clamp.

Temperature Control

The MIRacle can be configured with liquid jacketed plates and resistively heated crystal plates with temperature control module. The PC module (resistively heated only) includes PIKE TempPRO software which provides a graphical user interface for temperature control and kinetics measurements. The liquid jacketed plates require user-provided liquid circulator.



TempPRO software for graphical setup and control of kinetic measurements.

MIRacle ATR Summary

The MIRacle ATR accessory is a high-performance FTIR sampling tool for solid, liquid, or polymer samples. Easily changeable crystal plates provide optimized spectral data for unique sample types. With options for single, three or nine reflection crystal plates, several pressure clamp styles and heating or cooling, the MIRacle is able to address a wide range of FTIR sampling applications.

ORDERING INFORMATION

MIRACLE BASE OPTICS (must select)

PART NUMBER	DESCRIPTION
025-18XX	MIRacle ATR Base Optics/Platform Assembly

Notes: Replace **XX** with your spectrometer's Instrument Code. [Click for List >](#)
 MIRacle Base Optics includes purge tubes, purge kit and spectrometer base mount.

CRYSTAL PLATES FOR MIRACLE (must select 1 or more)

PART NUMBER	DESCRIPTION
025-2108	Diamond/ZnSe Performance Crystal Plate
025-2107	Diamond/ZnSe HS Performance Crystal Plate
025-2028	Diamond/KRS-5 Performance Crystal Plate
025-2027	Diamond/KRS-5 HS Performance Crystal Plate
025-2018	ZnSe Performance Crystal Plate
025-2058	Ge Performance Crystal Plate
025-2098	Si Performance Crystal Plate
025-2118	3-Reflection Diamond/ZnSe Performance Crystal Plate
025-2120	3-Reflection Diamond/ZnSe Performance Crystal Plate, Trough
025-2038	3-Reflection ZnSe Performance Crystal Plate
025-2218	9-Reflection Diamond/ZnSe Performance Crystal Plate, Trough
025-2208	Specular Reflection Performance Plate

Notes: MIRacle crystal plates are pre-aligned and pinned in place. Changing crystal plates is easy and fast to optimize sampling results. Crystal plate housings are manufactured using polished stainless steel for chemical resistance. The diamond/ZnSe and diamond/KRS-5 crystal plate is available with optional Hastelloy® (HS) metal for exceptionally caustic or acidic samples.

SPECIFICATIONS

ATR Crystal Choices	Diamond/ZnSe, Diamond/KRS-5, Ge, ZnSe, Si
Crystal Plate Mounting	User-changeable plates
Crystal Plate Mount	Stainless steel or Hastelloy
Angle of Incidence	45 degrees, nominal
Crystal Dimensions, surface	1.8 mm single reflection 6.0 mm three and nine reflection
Pressure Device	Rotating, continuously variable pressure; click-stop at maximum (High-Pressure Clamp)
Digital Force Adapter (option)	Load cell sensor for precise and reproducible pressure control. Attaches directly to High-Pressure MIRacle clamps. Digital readout. Not for use with heated plates.
Maximum Pressure	10,000 psi
Sample Access	55 mm, ATR crystal to pressure mount
Heating Options	Ambient to 60 or 130 °C maximum
Accuracy	+/- 0.5% of set point
Sensor Type	3 wire Pt RTD (low drift, high stability)
Temperature Control	Digital or digital with PC control (unlimited ramps, automated data collection, USB interface)
Input Voltage	100–240 VAC, auto setting, external power supply
Operating Voltage	1.3A/24 VDC 30 W
Specular Reflection Option	Optional, 45 degree nominal angle of incidence
Purge Sealing	Purge tubes and purge line connector included
Accessory Dimensions (W x D x H)	104 x 103 x 210 mm (excludes FTIR baseplate and mount)
FTIR Compatibility	Most, specify model and type

MIRACLE SAMPLING OPTIONS

PART NUMBER	DESCRIPTION
025-4018	Heated ZnSe Performance Crystal Plate
025-4058	Heated Ge Performance Crystal Plate
025-4108	Heated Diamond/ZnSe Performance Crystal Plate (60 °C max.)
025-2104	Liquid Jacketed Diamond/ZnSe Performance Crystal Plate, (60 °C max.)
025-2014	Liquid Jacketed ZnSe Performance Crystal Plate
025-2054	Liquid Jacketed Ge Performance Crystal Plate
025-2094	Liquid Jacketed Si Performance Crystal Plate
026-5012	Flow-Through Attachment, 100 µL
026-5013	Liquids Retainer and Volatiles Cover Set
026-3051	Volatiles Cover for Performance Plates
026-5010	Liquids Retainer for Performance Plates
076-1220	Digital Temperature Control Module
076-1420	Digital Temperature Control Module, PC Control

Notes: Flow-Through Attachment, Liquids Retainer and Volatiles Cover are compatible with non-trough crystal plate offerings and require High-Pressure Clamp, P/N 025-3020 or P/N 025-3035, sold separately. Temperature control module selection is required for heated crystal plates. Digital temperature control module with PC control includes TempPRO software. Liquid jacketed crystal plates require customer-provided circulator. Do not exceed 60 °C when using temperature controlled diamond plates and 130 °C for all others.

PRESSURE CLAMPS FOR MIRACLE

(must select clamp for solids or polymer analysis)

PART NUMBER	DESCRIPTION
025-3020	High-Pressure Clamp
076-6025	Digital Force Adapter for High-Pressure Clamp
025-3050	Micrometric, Low-Pressure Clamp
025-3035	High-Pressure Confined Space Clamp
076-6028	Digital Force Adapter for High-Pressure Confined Space Clamp

Notes: The High-Pressure Clamp is recommended for general applications. Pressure clamps include a flat tip, a swivel tip and a concave tip. The Digital Force Adapter requires High-Pressure Clamp, P/N 025-3020 or 025-3035 (sold separately), and may not be used at temperatures above ambient.

REPLACEMENT PARTS

PART NUMBER	DESCRIPTION
025-3095	Flat Tip for High-Pressure Clamp
025-3093	Swivel Tip for High-Pressure Clamp
025-3092	Concave Tip for High-Pressure Clamp
025-3052	Flat Tip for Micrometric Clamp
025-3061	Swivel Tip for Micrometric Clamp
025-3054	Concave Tip for Micrometric Clamp
025-3053	MIRacle Micrometer Clamp Tip Assortment
025-3094	7.8 mm ATR Pressure Tip for High-Pressure Clamp
025-3096	7.8 mm ATR Pressure Tip for Micrometer Clamp
025-3099	Tip Assortment for High-Pressure Clamp

Notes: Please contact PIKE Technologies for items not described in this list. Reconditioning service for used MIRacle crystal plates is available.

Dedicated MIRacle Sampling Tools and Options

Sealed Clamp

The Sealed Sample Chamber for the MIRacle Single Reflection ATR accessory attaches to dedicated single reflection diamond, ZnSe or Ge crystal ATR plates allowing the complete assembly to be moved from the spectrometer to a protective environment for sample handling. Once the sample has been loaded onto the ATR crystal, the sealed clamp may be engaged shielding the sample from the external environment. Typical applications include studies of toxic or chemically aggressive solids and powders.

The chamber is made of stainless steel and is sealed against the crystal plate with a chemically resistant O-ring. The chamber contains an internal, spring-loaded anvil that compresses the sample against the ATR crystal at a preset, clutch-controlled setting.



Liquids Retainer and Volatiles Cover

The Liquids Retainer offers a trough configuration for the MIRacle. The Volatiles Cover reduces the amount of evaporation of a highly volatile liquid sample on the surface of the crystal. The High-Pressure Clamp is required, and serves to apply pressure to the u-bridge thus compressing a sealing PTFE O-ring located underneath the Liquids Retainer.



Temperature Control Options

The MIRacle can be configured with liquid jacketed plates and resistively heated crystal plates with temperature control module. The PC module (resistively heated only) includes PIKE TempPRO software which provides a graphical user interface for temperature control and kinetics measurements. The liquid jacketed plates require user-provided liquid circulator.



Digital Force Adapter for High-Pressure Clamp

The Digital Force Adapter attaches directly to the clamping assembly to precisely measure the applied force by using an embedded load cell that exhibits high linearity and exceptional accuracy. The magnitude of applied force is displayed on an external easy-to-read LCD readout. The digital clamp is ideal for applications that require controlled and reproducible pressure. This option may not be used with temperature controlled plates.



Flow-Through Attachment

The Flow-Through Attachment is used for continuous monitoring or handling samples that pose a hazard or are degraded from ambient exposure. Samples are introduced using the Luer-Lok™ fitting by connecting a syringe or a flow line. Swagelok® fittings are optional. The High-Pressure Clamp is required.



Specular Reflection Plate

The MIRacle may be converted from an ATR accessory to a specular reflection accessory by using the Specular Reflection Plate. The angle of incidence is 45 degrees, and the plate is easily interchangeable with ATR plates.



ORDERING INFORMATION

SEALED HIGH-PRESSURE CLAMP FOR MIRACLE (must select the sealed clamp and at least one crystal ATR plate).

PART NUMBER	DESCRIPTION
025-6020	Sealed High-Pressure Clamp
025-6108	Diamond/ZnSe Sealed Clamp Performance Plate
025-6018	ZnSe Sealed Clamp Performance Plate
025-6058	Ge Sealed Clamp Performance Plate

TEMPERATURE CONTROLLED MIRACLE OPTIONS

PART NUMBER	DESCRIPTION
025-4018	Heated ZnSe Performance Crystal Plate
025-4058	Heated Ge Performance Crystal Plate
025-4108	Heated Diamond/ZnSe Performance Crystal Plate, (60 °C max.)
025-2104	Liquid Jacketed Diamond/ZnSe Performance Crystal Plate, (60 °C max.)
025-2014	Liquid Jacketed ZnSe Performance Crystal Plate
025-2054	Liquid Jacketed Ge Performance Crystal Plate
025-2094	Liquid Jacketed Si Performance Crystal Plate
076-1220	Digital Temperature Control Module
076-1420	Digital Temperature Control Module, PC Control

Temperature controller is required for heated crystal plates. Digital temperature controller, PC control includes PIKE TempPRO software. Liquid jacketed crystal plates require customer-provided circulator.

MORE MIRACLE SAMPLING OPTIONS

PART NUMBER	DESCRIPTION
025-2208	Specular Reflection Performance Plate
025-2028	Diamond/KRS-5 Performance Crystal Plate
026-3051	Volatiles Cover for Performance Plates
026-5013	Liquids Retainer and Volatiles Cover Set
076-6025	Digital Force Adapter for High-Pressure Clamp
026-5012	Flow-Through Attachment, 100 µL

GladiATR – Highest Performance Diamond ATR



The energy throughput of the GladiATR is exceptional. This significantly improves spectral quality and reduces sampling time.

The GladiATR is designed and manufactured using all reflecting optics providing full spectral range in the mid-IR and far-IR spectral regions. An optional Ge crystal plate is available for analysis of high refractive index samples, and offers a spectral range from 5000 – 450 cm^{-1} . The crystal plates are easily changeable.

The GladiATR high performance diamond ATR is available in configurations to fit most FTIR spectrometers.

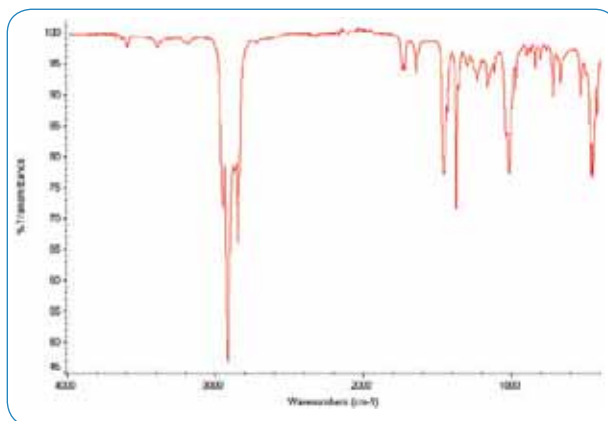

ATR/FTIR spectrum of polymer pellet run on GladiATR with diamond crystal. Spectral range in the mid-IR is 4000–400 cm^{-1} .

FEATURES

- Diamond crystal design – cannot scratch or fracture
- Extreme pressure application – for hard and demanding solid samples
- Highest energy throughput design – for excellent-quality FTIR spectra and minimum scan time
- All reflective optics – full spectral range for analysis in the mid-IR and far-IR regions
- Optional extended spectral range Ge crystal plate – for high refractive index samples
- Heated crystal plate options – ATR temperature studies up to 300 °C
- Compatible with most FTIR spectrometers

The GladiATR™ ATR from PIKE Technologies features an optical design providing the highest energy throughput, highest available pressure, widest spectral range and offering optional heated or cooled crystal plates. The GladiATR is a highly durable and rugged design to be used in environments where large numbers of samples are measured, where samples may be intractable solids, where you want the best quality spectrum every time and where you need flexibility for new sample types in the future.

The GladiATR diamond crystal is a monolithic design which will not scratch or fracture even at extreme pressures. This design permits analysis of hard, intractable objects such as coated metal wires, polymer pellets and geological samples without damage to the ATR crystal. The diamond crystal is brazed into the stainless steel or Hastelloy plate, which enables this ATR to be compatible with pressure up to 30,000 psi.

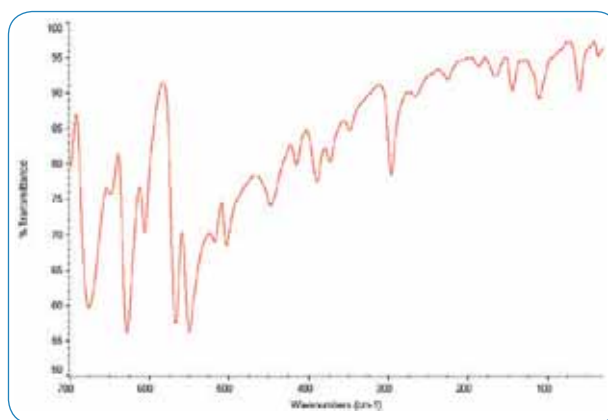

Spectrum of sulfathiazole collected using GladiATR with diamond crystal plate and far-IR optics in FTIR instrument.

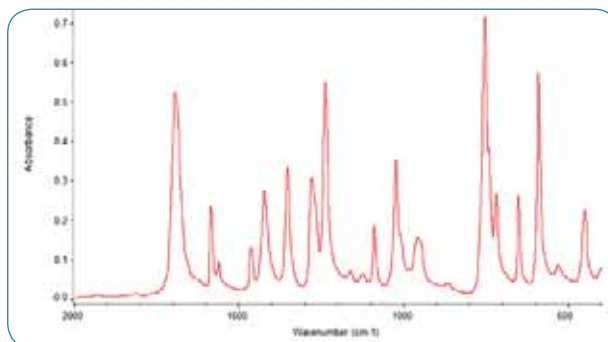

Spectrum of bromoacetophenone collected using GladiATR with expanded range Ge crystal plate.



GladiATR with 300 °C heated diamond crystal plate and temperature controller.

Temperature controlled crystal plates are available for thermal study of materials. The resistively heated diamond plate has a range from ambient to 210 or 300 °C. PIKE Technologies offers temperature controllers with digital and PC programmable set points with TempPRO software, which allows for easily programmed temperature profile and data collection by interfacing with most FTIR software platforms. For sub-ambient studies, liquid jacketed plates are an option. The new liquid jacketed/heated GladiATR diamond plate blends the benefits of both resistively heated and liquid jacketed.

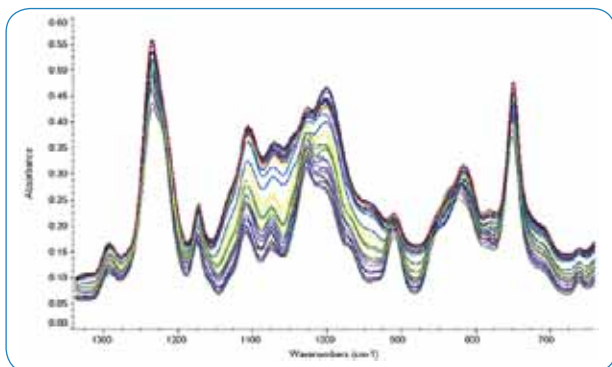

ATR/FTIR spectra from cure of thermoset epoxy using the heated diamond crystal plate on the GladiATR.



Selection of the digital control module, PC control includes PIKE TempPRO™ software for graphical setup and automated data collection for thermal experiments.

SPECIFICATIONS	
ATR Crystal Choices	Diamond, germanium
Crystal Plate Mounting	User changeable plates
Crystal Type	Monolithic
Diamond Mounting	Brazed
Crystal Plate Mounts	Stainless steel
Angle of Incidence	45 degrees, nominal
Crystal Dimensions (surface)	3.0 mm diameter
Optics	All reflective
Pressure Device	Rotating, continuously variable pressure; click stop at maximum
Digital Force Adapter (option)	Load cell sensor for precise and reproducible pressure control. Attaches directly to GladiATR clamp. Digital readout. For ambient temperature measurements only.
Maximum Pressure	30,000 psi
Sample Access	80 mm, ATR crystal to pressure mount
Spectral Range, Diamond	4000 to 30 cm ⁻¹ (IR optics dependent)
Spectral Range, Ge	4000 to 450 cm ⁻¹
Heating Options	Diamond, 210 or 300 °C maximum
Accuracy	+/- 0.5% of set point
Sensor Type	3 wire Pt RTD (low drift, high stability)
Temperature Control	Digital or digital with PC control (up to 20 ramps, automated data collection, USB interface)
Input Voltage	
210 °C version	100–240 VAC, auto setting, external power supply
300 °C version	110/220 VAC switchable
Operating Voltage	4A/24 VDC, 100 W 6A/24 VAC, 150 W (300 °C version)
Cooling Options	Liquid jacketed crystal plates available
Specular Reflection Option	Optional, 45 degree nominal angle of incidence
Purge Sealing	Purge tubes and purge line connector included
Accessory Dimensions (W x D x H)	140 x 205 x 340 mm (excludes FTIR baseplate and mount)
FTIR Compatibility	Most, specify model and type

ORDERING INFORMATION

GLADIATR BASE OPTICS (must select)

PART NUMBER	DESCRIPTION
026-18XX	GladiATR Single Reflection ATR Base Optics, with heating capability up to 210 °C or 300 °C

Notes: Replace XX with your spectrometer's Instrument Code. [Click for List >](#)
All GladiATRs include purge tubes, purge kit, and selected spectrometer base mount. Crystal plates must be selected from the table below. High-Pressure Clamp, Digital Force Adapter and Liquids Retainer/Volatiles Cover are optional and need to be ordered separately, if required.

GLADIATR STAINLESS TOP (must select one or more)

PART NUMBER	DESCRIPTION
026-2001	GladiATR Standard Stainless Top
026-2002	GladiATR Heated Stainless Top
026-2003	GladiATR Liquid Jacketed Stainless Top

Notes: Stainless top is not required for 300 °C version. For liquid jacketed/heated plate (P/N 026-4200) order 026-2002.

CRYSTAL PLATES FOR GLADIATR (must select one or more)

PART NUMBER	DESCRIPTION
026-2100	Diamond Crystal Plate
026-2050	Ge Crystal Plate
026-2200	Specular Reflection Plate

Notes: GladiATR crystal plates are pre-aligned and pinned-in-place. Changing crystal plates is easy and fast to optimize sampling results. Plate housing is stainless steel; contact us for Hastelloy options. Reconditioning service is available.

PRESSURE CLAMP FOR GLADIATR, ALL MODELS (must select for solid or powdered samples)

PART NUMBER	DESCRIPTION
026-3020	High-Pressure Clamp
076-6026	Digital Force Adapter for High-Pressure Clamp

Notes: The High-Pressure Clamp is required for analysis of solids, powders and use of Liquids Retainer, Flow-Through Attachment and/or Digital Force Adapter (Digital Force Adapter may be used when measuring samples at ambient temperature only). Pressure clamp includes a flat tip, a swivel tip and a concave tip.

GLADIATR TEMPERATURE CONTROLLED CRYSTAL PLATES

PART NUMBER	DESCRIPTION
026-4102	Heated Diamond Crystal Plate, 300 °C
026-4100	Heated Diamond Crystal Plate, 210 °C
026-4200	Liquid Jacketed/Heated Diamond Crystal Plate
026-4110	Liquid Jacketed Diamond Crystal Plate
026-4050	Heated Ge Crystal Plate, 130 °C
026-4150	Liquid Jacketed Ge Crystal Plate, 130 °C
076-1220	Digital Temperature Control Module, 210 °C
076-1420	Digital Temperature Control Module, PC Control, 210 °C
076-1210	Digital Temperature Control Module, 300 °C
076-1410	Digital Temperature Control Module, PC Control, 300 °C

Notes: For heated diamond crystal plates, maximum crystal temperature is 300 or 210 °C. Ge becomes optically opaque at 150 °C; maximum recommended temperature for this crystal is 130 °C. Temperature controller is required for heated crystal plates. Digital temperature controller, PC control includes PIKE TempPRO software. Liquid jacketed crystal plates require customer-provided circulator.

GLADIATR SAMPLING OPTIONS

PART NUMBER	DESCRIPTION
025-3095	Flat Tip for High-Pressure Clamp
025-3093	Swivel Tip for High-Pressure Clamp
025-3092	Concave Tip for High-Pressure Clamp
025-3099	High-Pressure Tip Assortment
026-5012	Flow-Through Attachment, 210 °C, 100 µL
026-5014	Flow-Through Attachment, 300 °C, 100 µL
026-5013	Liquids Retainer and Volatiles Cover Set
026-3051	Volatiles Cover
026-5015	Liquids Retainer and Volatiles Cover Set, 300 °C
026-5010	Liquids Retainer, 260 °C

Note: Flow-Through Attachment and Liquids Retainer are compatible with all crystal offerings (require High-Pressure Clamp).

GladiATR Vision – Diamond ATR with Sample View



FEATURES

- View through diamond crystal – easily find sample point
- 110X magnification – find and position small sample areas
- USB image capture – document sample image
- Diamond crystal design – scratch and fracture resistant
- Highest energy throughput design – for excellent quality FTIR spectra and minimum scan time
- All reflective optics – full spectral range for mid-IR and far-IR analysis
- Optional heated, viewing crystal plate

The GladiATR Vision™ is a novel sampling tool which couples small area infrared analysis with simultaneous viewing. Samples are placed face down and positioned on the diamond crystal while its image is projected in real-time on the LCD screen. Finding and optimizing the sample placement for specific analysis areas is easy and fast! Analysis of thick or non-transparent samples is no problem because viewing is through the diamond crystal.

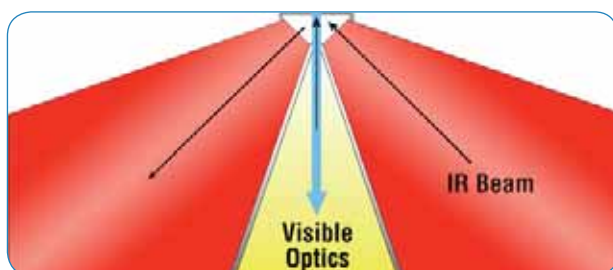

Diamond crystal plate of the GladiATR Vision accessory. IR beam and visible illumination meet at the sample position.

The GladiATR Vision accessory utilizes an innovative optical design with IR beam and visible optical image converging at the sample position – ensuring that “What you see is what you sample!” The 110X magnification of the sample image enables the positioning of even relatively small samples into the center of the diamond crystal for optimized analysis. Analysis of samples as small as 50 microns in size is doable with the GladiATR Vision accessory. Visible images from the GladiATR Vision are of highest quality color rendition because its refractive optics are fully transparent.

The GladiATR Vision optical design is all reflective, preserving the full spectral range inherent to diamond. For standard mid-IR FTIR spectrometers, the spectral range available with the GladiATR Vision will be 4000–400 cm^{-1} . For FTIR spectrometers equipped with far-IR optics, the spectral range is extended to less than 50 cm^{-1} .

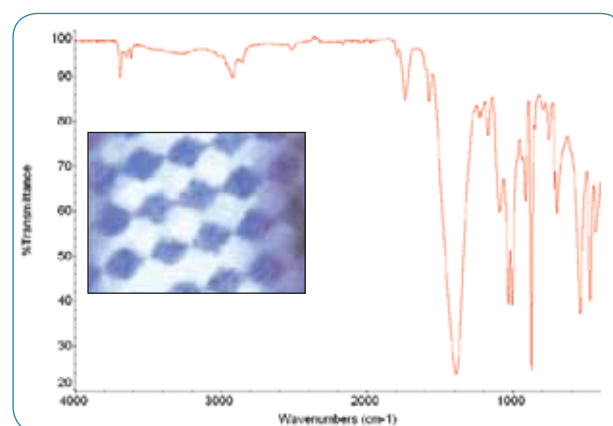

ATR spectrum of print area on paper run on GladiATR Vision with diamond crystal. Image of the analysis area is shown in the inset. Spectral range is 4000–400 cm^{-1} with standard FTIR optics.

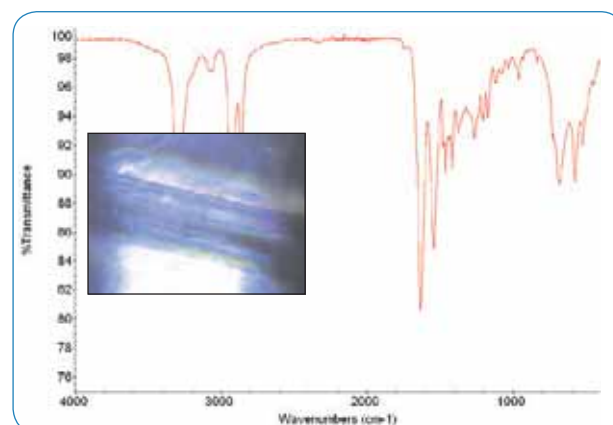

ATR spectrum of 200-micron fiber run on GladiATR Vision with diamond crystal. Compressed fiber image is shown with the spectrum.

Temperature controlled crystal plates are available for thermal study of materials. The resistively heated diamond Vision plate has a temperature range from ambient to 210 °C. PIKE Technologies offers temperature controllers with digital and PC programmable set points with TempPRO software, which allows for easily programmed temperature profiles and data collection by interfacing with most FTIR software platforms. For applications requiring temperatures from sub-ambient to 210 °C, liquid jacketed plates are available.

The viewing specular reflection plate transforms the GladiATR Vision into a 45 degree specular reflection accessory, uniquely allowing the sampling spot, such as a defect, to be easily located. With the small spot size of 3 mm, you can be confident of your sampling point.

The GladiATR Vision diamond ATR is available in configurations to fit most FTIR spectrometers.

SPECIFICATIONS	
ATR Crystal Choices	Diamond, germanium (non-viewing)
Crystal Plate Mounting	User changeable plates
Crystal Type	Monolithic
Diamond Mounting	Brazed
Crystal Plate Mounts	Stainless steel
Angle of Incidence	45 degrees, nominal
Crystal Dimensions (surface)	3.0 mm diameter
Optics	All reflective
Pressure Device	Rotating, continuously variable pressure; click stop at maximum
Digital Force Adapter (option)	Load cell sensor for precise and reproducible pressure control. Attaches directly to GladiATR clamp. Digital readout. For ambient temperature measurements only.
Maximum Pressure	30,000 psi
Sample Access	80 mm, ATR crystal to pressure mount
Spectral Range, Diamond	4000 to 30 cm ⁻¹ (IR optics dependent)
Viewing	Integrated 4" LCD
Magnification	110X magnification
View Area	770 x 590 microns
Optional Image Save	USB image capture
Viewing Mode	Through diamond crystal
Input Voltage	100–240 V, auto setting, external power supply
Operating Voltage, Wattage	12 VDC, 18 W maximum
Heating Options	Diamond, 210 °C maximum
Accuracy	+/- 0.5% of set point
Sensor Type	3 wire Pt RTD (low drift, high stability)
Temperature Control	Digital or digital with PC control (up to 100 ramps, automated data collection, USB interface)
Input Voltage	100–240 VAC, auto setting, external power supply
Operating Voltage	4A/24 VDC 100 W
Specular Reflection Option	Viewing, 45 degree nominal angle of incidence
Purge Sealing	Purge tubes and purge line connector included
Accessory Dimensions (W x D x H)	140 x 225 x 340 mm (excludes FTIR baseplate and mount)
FTIR Compatibility	Most, specify model and type

ORDERING INFORMATION

GLADIATR VISION BASE OPTICS *(must select one)*

PART NUMBER	DESCRIPTION
026-19XX	GladiATR Vision Base Optics

Notes: Replace **XX** with your spectrometer's Instrument Code. [Click for List >](#) GladiATR Vision Base Optics versions include purge tubes, illumination power supply, purge kit and spectrometer base mount. USB interface software included enables image capture on your PC.

GLADIATR STAINLESS TOP *(must select one or more)*

PART NUMBER	DESCRIPTION
026-2004	GladiATR Vision Stainless Top
026-2005	GladiATR Vision Heated Stainless Top
026-2006	GladiATR Vision Liquid Jacketed Stainless Top

CRYSTAL PLATES FOR GLADIATR VISION *(must select one or more)*

PART NUMBER	DESCRIPTION
026-2102	GladiATR Vision Diamond Crystal Plate
026-2050	Ge Crystal Plate (non-viewing)
026-2202	Specular Reflection Plate (viewing)
026-2200	Specular Reflection Plate (non-viewing)

Notes: GladiATR Crystal Plates are pinned-in-place. Changing crystal plates is easy and fast to optimize sampling results. Only the GladiATR Vision Diamond Crystal Plate and viewing specular reflectance are compatible with sample viewing.

HIGH-PRESSURE CLAMP FOR GLADIATR VISION

(must select for solid or powdered samples)

PART NUMBER	DESCRIPTION
026-3020	High-Pressure Clamp
076-6026	Digital Force Adapter for High-Pressure Clamp

Notes: The High-Pressure Clamp is required for analysis of solids, powders and for use of liquids retainer and/or Digital Force Adapter (Digital Force Adapter may be used with samples at ambient temperature only). Pressure clamp includes a flat tip, a swivel tip and a concave tip.

GLADIATR VISION TEMPERATURE CONTROLLED CRYSTAL PLATE

PART NUMBER	DESCRIPTION
026-4101	Heated Diamond Crystal Plate, 210 °C (viewing)
026-4050	Heated Ge Crystal Plate, 130 °C (non-viewing)
026-4112	Liquid Jacketed Diamond Crystal Plate, 210 °C max (viewing)
076-1220	Digital Temperature Control Module
076-1420	Digital Temperature Control Module, PC Control

Notes: For heated diamond crystal plates, maximum crystal temperature is 210 °C. Ge becomes optically opaque at 150 °C. Maximum recommended temperature for this crystal is 130 °C. Temperature controller is required for heated crystal plates. Digital temperature controller, PC control includes PIKE TempPRO software. Liquid jacketed crystal plates require customer-provided circulator.

GLADIATR VISION SAMPLING OPTIONS

PART NUMBER	DESCRIPTION
026-5012	Flow-Through Attachment, 100 µL
026-5013	Liquids Retainer and Volatiles Cover Set
026-3051	Volatiles Cover
026-5010	Liquids Retainer

Note: Flow-Through Attachment and Liquids Retainer are compatible with all crystal offerings (High-Pressure Clamp required).

Dedicated GladiATR and GladiATR Vision Sampling Tools – More Options to Address Your Specific Application Requirements

Extended Range Ge Crystal Plate

Due to the compact crystal size and the all reflective optics of the GladiATR platform, the Ge Crystal Plate offers an extended spectral range from 4000–450 cm^{-1} . A Ge ATR crystal is used to measure samples with a high refractive index. Types of high refractive materials that would benefit from sampling on the extended range Ge ATR crystal are carbon black filled samples and inorganic materials such as oxides, aluminas, titania, and minerals. The Ge crystal plate (non-viewing) may be fitted to the GladiATR or GladiATR Vision. Crystal plates are easily interchangeable. A heated version is available.

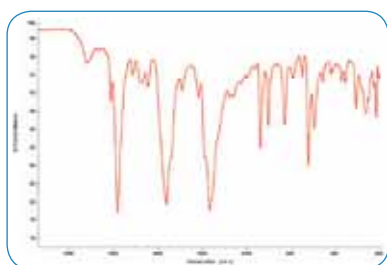

Spectrum of malachite green oxalate collected using the GladiATR with Ge crystal plate.

Specular Reflection Plate

The GladiATR may be converted from an ATR accessory to a specular reflection accessory by using the Specular Reflection Plate. A viewing Specular Reflection Plate is available for the GladiATR Vision. The angle of incidence is 45 degrees, and plate is easily interchangeable with ATR plates.



GladiATR Specular Reflection Plate

Temperature Control

The GladiATR and GladiATR Vision can be fitted for temperature control by configuring the accessory with a liquid jacketed or resistively heated diamond or Ge plate. When coupled with the PC temperature controller, up to 100 temperature ramps are easily programmed using PIKE TempPRO, which also interfaces with many FTIR software packages for data collection as a function of time or temperature.



Heated GladiATR with temperature control module

Flow-Through Attachment

The Flow-Through Attachment is used for continuous monitoring or handling samples that pose a hazard from ambient exposure. Samples are introduced using the Luer-Lok fitting by connecting a syringe or a flow line. 1/16 inch compression fittings are optional. The High-Pressure Clamp is required.



Flow-Through Attachment

Liquids Retainer and Volatiles Cover

The Liquids Retainer offers a trough configuration for GladiATR and GladiATR Vision. The volatiles cover reduces the amount of evaporation of a highly volatile liquid sample placed on the surface of the crystal. The High-Pressure Clamp is required.

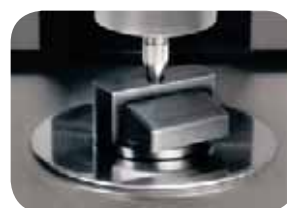

Liquids Retainer and Volatiles Cover Set

ORDERING INFORMATION

GLADIATR OPTIONS

PART NUMBER	DESCRIPTION
026-2050	Ge Crystal Plate (non-viewing)
026-4050	Heated Ge Crystal Plate, 130 °C (non-viewing)
026-4100	Heated Diamond Crystal Plate, 210 °C (non-viewing)
026-4101	Heated Diamond Crystal Plate, 210 °C (viewing)
026-4102	Heated Diamond Crystal Plate, 300 °C (non-viewing)
076-1220	Digital Temperature Control Module
076-1420	Digital Temperature Control Module, PC control
026-4110	Liquid Jacketed Diamond Crystal Plate (non-viewing)
026-4112	Liquid Jacketed Diamond Crystal Plate, 210 °C max (viewing)
026-2200	Specular Reflection Plate (non-viewing)
026-2202	Specular Reflection Plate (viewing)
026-5012	Flow-Through Attachment, 210 °C, 100 μL
026-5014	Flow-Through Attachment, 300 °C, 100 μL
026-5013	Liquids Retainer and Volatiles Cover Set
026-5010	Liquids Retainer
026-3051	Volatiles Cover
026-5015	Liquids Retainer and Volatiles Cover Set, 300 °C

Notes: The heated crystal plates require a temperature control module and appropriate stainless steel top. For more heated options, please review the GladiATR and GladiATR Vision accessory product data sheets.

Multiple Reflection HATR – Maximum Sensitivity and Highly Versatile FTIR Sampling

HATR Accessory –
in-compartment
HATR for liquid
and solid
samples



HATRPlus™ Accessory –
out-of-compartment
HATR for liquid
and extra large
solid samples

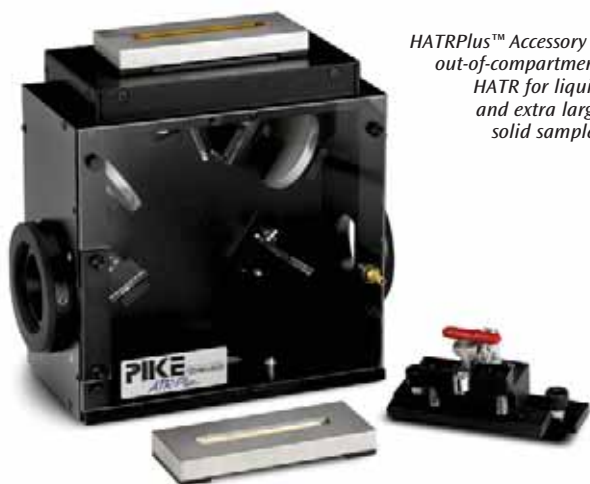

Horizontal Attenuated Total Reflectance (HATR) accessories successfully replace constant path transmission cells, salt plates and KBr pellets used in the analysis of liquid, semi-liquid materials and a number of solids. HATRs feature a constant and reproducible effective pathlength and are well suited for both qualitative and quantitative applications. In general, sampling is achieved by placing the sample onto the HATR crystal – generally eliminating sample preparation.

The PIKE Technologies HATR accessory provides high sensitivity for analysis of low concentration components in liquid, solid, and polymer samples. To optimize spectral measurements a selection of crystal materials, sample formats, and temperature and flow-through configurations are available.

PIKE Technologies HATR products are available in two base optic configurations. The HATR is an **in-compartment** design for samples which fit into the FTIR sample compartment. The HATRPlus is an **out-of-compartment** design for samples which are larger and do not fit into the FTIR sample compartment. The sampling surface of the HATRPlus extends above the FTIR cover, thereby permitting analysis of very large samples. Applications examples include coatings on large manufactured components, layered composition analysis on large objects, and skin analysis in the health and personal care industries.

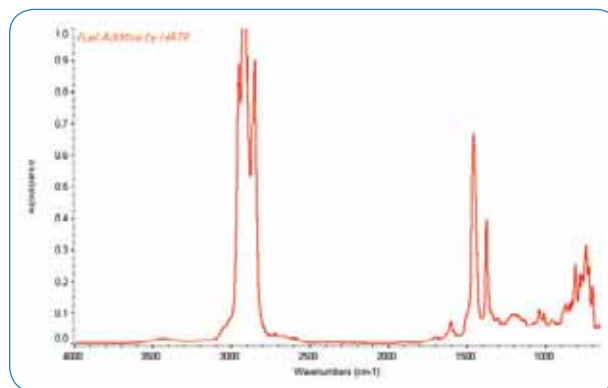

FTIR spectrum of fuel additive using HATR trough plate with ZnSe crystal.

FEATURES

- Excellent energy throughput offering high signal-to-noise ratio and spectral quality
- Up to 20 internal reflections on the sample for maximum sensitivity for low concentration components
- Removable crystal plates with pinned positioning for high precision and quick cleanup
- HATR plates with ZnSe, KRS-5, Ge, AMTIR or Si crystals with selectable face angles to optimize sampling depth
- In-compartment (HATR) and out-of-compartment (HATRPlus) versions for small and extra large sample sizes
- Several temperature controlled and flow-through crystal options

The PIKE Technologies HATRs are high-performance accessories, carefully designed to provide excellent results with minimum effort. Accessories are easily installed in the sample compartment, locking into position on the sample compartment baseplate.

Stable alignment provides excellent analytical precision. Crystal plate changeover is rapid, allowing a wide range of samples to be analyzed with maximum convenience. PIKE Technologies HATRs have been optimized for maximum optical throughput and excellent quality spectra can be obtained from demanding samples. Several high-quality crystal materials covering a full spectrum of applications are available. Trough and sealed flat crystal plates are sealed using metallic gaskets, eliminating premature failure and the risk of cross-contamination associated with inferior, epoxy-bonded systems. Flat crystal plates are designed with positive surface relief to aid in improved sample contact.

All PIKE HATRs include a purge tube interface for the FTIR spectrometer. This provides full integration of the accessory with the FTIR spectrometer's purging system (sealed and desiccated or purged) for removal of water and carbon dioxide artifacts from the FTIR spectra. Thanks to this, purging is very efficient and the spectrometer can be operated with the sample compartment door open.

HATR Crystal Plate Choices

PIKE Technologies HATR crystal plates are available in trough, flat plate and flow cell configurations.



Ge Flat Plate

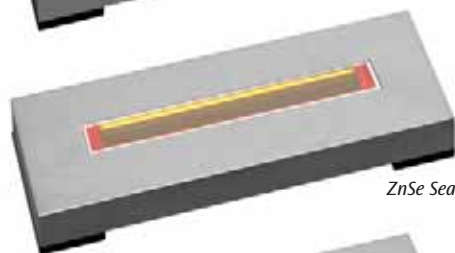

ZnSe Sealed Flat Plate



ZnSe Trough Plate

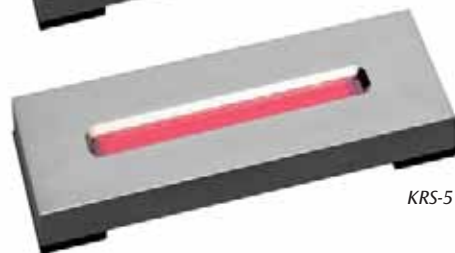

KRS-5 Trough Plate

The **flat plate** is used for the analysis of solid materials – including polymer and film samples. It is ideal for solid samples which are too large to fit within the trough plate configuration. The crystal is mounted slightly above the surface of the metal plate, which helps to achieve good crystal/sample contact when the flat plate press is used.

The ZnSe and Ge 45-degree flat plates are available in a sealed version, which is ideal for sampling of oils and other types of low surface tension liquids.



Flat HATR crystal plate – ideal for solids, polymer films and coatings.

The **trough plate** is designed for easy sampling, with a large, recessed crystal to accommodate the sample – generally a liquid, powder, or paste. The trough plate is ideal when samples must be cleaned from the crystal with some type of aqueous or organic solvent. Typically, only a thin layer of the sample needs to be applied onto the crystal surface. For fast evaporating samples, a volatiles cover should be used to cover the sampling area.

Soft powders will often produce good spectra when analyzed by HATR, assuming that they can be put in intimate contact with the crystal. A powder press option is used to achieve this. This device is placed directly on top of the sample filled trough and pressed by hand until the desired result is obtained.



Trough HATR crystal plate – ideal for liquids, powders, pastes and gels.

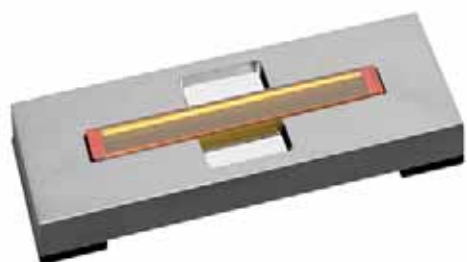

RCPlate

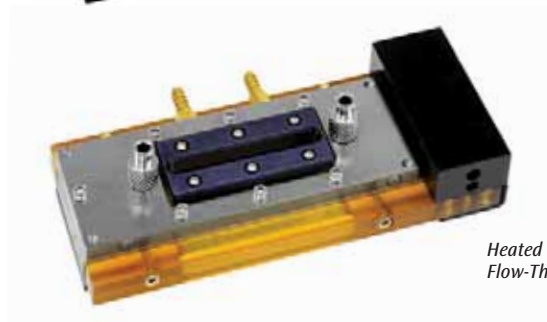

Heated UV HATR Flow-Through Cell

RCPlate™

For special applications where you need to look at coatings on an HATR crystal, PIKE Technologies offers the RCPlate option. The RCPlate is designed to enable easy removal and reinsertion of the HATR crystal. Applications include analysis of coatings, monomolecular layers, or bio-films deposited directly upon the HATR crystal. With RCPlates, it is easy to collect the background spectrum on the clean crystal, remove the HATR crystal from the RCPlate, coat the crystal and then reposition it into the RCPlate to collect the sample spectrum.

Flow-Through Cell

Flow-through cells are a versatile option for the dynamic laboratory. The ATR crystal is sealed in with O-rings, which allows for user-changeable crystals. The sample may be introduced by syringe or through tubing connected to a 1/16-inch compression fitting. Flow-through cells may be configured for temperature control and with PTFE coating.

In addition to our standard flow-through cells, PIKE offers a flow-through cell with a quartz window for photocatalytic studies. Due to UV-induced degradation of ZnSe caused by the external source probe, we recommend using an AMTIR crystal for these applications.



HATR with Heated Trough Plate and temperature control module – foreground shows Heated Flow-Through Cell.

All resistively heated HATR plates and flow-through cells are controlled by PIKE temperature controllers in digital or digital PC versions. The selection of the digital PC version includes PIKE TempPRO software, which provides a graphical user interface for temperature control and kinetic measurements.

A large number of flat, trough and flow-through sampling plates are available for PIKE Technologies HATRs – all are pin-mounted to the HATR with no alignment required. They are compatible and interchangeable with HATR and HATRPlus products which allows optimizing the accessory's configuration for best spectral results.

Do you need an HATR product or feature not shown here in our catalog? Please contact us to discuss your application.



HATR with Flow-Through Cell (background). Liquid Jacketed Trough Plate is shown in foreground (left).



PIKE TempPRO Software for kinetic experiments with our Resistively Heated Crystal Plates.

SPECIFICATIONS

Temperature Range	Ambient to 130 °C
Accuracy	+/- 0.5% of set point
Sensor Type	3 wire Pt RTD (low drift, high stability)
Controllers	
Digital	+/- 0.5% of set point
Digital PC	+/- 0.5% of set point, graphical setup, up to 100 ramps, USB interface
Input Voltage	100–240 VDC, auto setting, external power supply
Output Voltage	24 VDC/50 W maximum
HATR Crystals	ZnSe, Si, Ge, AMTIR and KRS-5
Crystal Dimensions	80 x 10 x 4 mm or 80 x 10 x 2 mm
Number of Reflections on the Sample	10 for 45 degree, 4-mm thick 20 for 45 degree, 2-mm thick 5 for 60 degree, 4-mm thick
Base Dimensions (W x D x H)	115 x 55 x 70-104 mm (excludes baseplate and purge collars; base height depends on the beam height of the spectrometer)

ORDERING INFORMATION

Complete HATR Systems

BUNDLED HATR SYSTEMS (insert spectrometer model for XX)

PART NUMBER	DESCRIPTION
022-10XX	HATR Trough Plate System with 45° ZnSe Crystal <i>Includes Trough Plate, Volatiles Cover and Powder Press</i>
022-11XX	HATR Flat Plate System with 45° ZnSe Crystal <i>Includes Flat Plate and HATR Pressure Clamp</i>
022-12XX	HATR Combined Trough and Flat Plate System with 45° ZnSe Crystals <i>Includes Trough Plate, Flat Plate, Volatiles Cover, Powder Press and Pressure Clamp</i>
024-11XX	HATRPlus Flat Plate System with 45° ZnSe Crystal <i>Includes Flat Plate and HATR Pressure Clamp</i>

Notes: Replace **XX** with your spectrometer's Instrument Code. [Click for List >](#)
HATR and HATRPlus systems may be purchased with crystal plates other than ZnSe. Just add -Ge for germanium, -KR for KRS-5, -AM for AMTIR, or -Si for silicon to the part number. Additional plates can be added to an order for any system above. Other configurations may be selected from the options below.

Configurable HATR Systems

HATR BASE OPTICS

PART NUMBER	DESCRIPTION
022-19XX	HATR Platform Optics Assembly
024-19XX	HATRPlus Platform Optics Assembly

Notes: Replace **XX** with your spectrometer's Instrument Code. [Click for List >](#)
HATR and HATRPlus Platform Optics Assemblies include volatiles cover, powder press, purge tubes, purge kit and spectrometer base mount.

PRESSURE CLAMP FOR HATR AND HATRPLUS

(must select for solids, films or powder analysis)

PART NUMBER	DESCRIPTION
022-3050	HATR (pivoting) Pressure Clamp
022-3054	HATR High-Pressure Clamp
024-3050	HATRPlus (pivoting) Pressure Clamp
024-3053	HATRPlus High-Pressure Clamp

Notes: The pressure clamp is required for solids, films, coatings and powdered samples. Maximum force for (pivoting) Pressure Clamp and High-Pressure Clamp is 13 lbs and 30 lbs, respectively.

CRYSTAL PLATES FOR HATR AND HATRPLUS

(must select 1 or more)

PART NUMBER	DESCRIPTION
022-2010-45	Trough Plate, ZnSe, 45°
022-2020-45	Flat Plate, ZnSe, 45°
022-2024-45	Sealed Flat Plate, ZnSe, 45°
022-2012-45	Trough Plate, ZnSe, 45°, 2 mm
022-2022-45	Flat Plate, ZnSe, 45°, 2 mm
022-2030-45	Trough Plate, KRS-5, 45°
022-2040-45	Flat Plate, KRS-5, 45°
022-2050-45	Trough Plate, Ge, 45°
022-2060-45	Flat Plate, Ge, 45°
022-2064-45	Sealed Flat Plate, Ge, 45°
022-2052-45	Trough Plate, Ge, 45°, 2 mm
022-2062-45	Flat Plate, Ge, 45°, 2 mm
022-2070-45	Trough Plate, AMTIR, 45°
022-2080-45	Flat Plate, AMTIR, 45°
022-2090-45	Trough Plate, Si, 45°
022-2100-45	Flat Plate, Si, 45°

Notes: HATR Crystal Plates are pre-aligned and pinned-in-place. Changing crystal plates is easy and fast to optimize sampling results. For most HATR crystal plates, 60 degree face angle is also available. Where not noted, crystals are 4-mm thick and generate 10 reflections on the sample (45° cut). 2-mm crystals result in 20 reflections (45° cut). If you need a crystal not listed here, please contact us. Reconditioning service is available.

ORDERING INFORMATION

HEATED CRYSTAL PLATES FOR HATR AND HATRPLUS

PART NUMBER	DESCRIPTION
022-5110	HATR Heated Trough Plate, ZnSe, 45°
022-5120	HATR Heated Trough Plate, AMTIR, 45°
022-5130	HATR Heated Trough Plate, KRS-5, 45°
022-5140	HATR Heated Trough Plate, Si, 45°
022-5150	HATR Heated Trough Plate, Ge, 45°

PART NUMBER	DESCRIPTION
022-5210	HATR Heated Flow-Through Cell, ZnSe, 45°
022-5212	HATR Heated Flow-Through Cell, ZnSe, 45°, 2 mm
022-5220	HATR Heated Flow-Through Cell, AMTIR, 45°
022-5230	HATR Heated Flow-Through Cell, KRS-5, 45°
022-5240	HATR Heated Flow-Through Cell, Si, 45°
022-5250	HATR Heated Flow-Through Cell, Ge, 45°
022-5252	HATR Heated Flow-Through Cell, Ge, 45°, 2 mm
022-5225	HATR Heated Flow-Through Cell with UV Port, AMTIR, 45°

PART NUMBER	DESCRIPTION
076-1420	Digital Temperature Control Module, PC Control
076-1220	Digital Temperature Control Module

Notes: Temperature is adjustable to 130 °C for heated trough plates and flow-through cells. Ge becomes opaque near 100 °C. Resistance heated plates require selection of a PIKE Technologies Temperature Control Module. PC Control Module includes PIKE Technologies TempPRO software. PTFE-coated flow-through cells available – contact us for more information.

FLOW-THROUGH CELLS FOR HATR AND HATRPLUS

PART NUMBER	DESCRIPTION
022-4010	HATR Flow-Through Cell, ZnSe, 45°
022-4012	HATR Flow-Through Cell, ZnSe, 45°, 2 mm
022-4020	HATR Flow-Through Cell, AMTIR, 45°
022-4030	HATR Flow-Through Cell, KRS-5, 45°
022-4040	HATR Flow-Through Cell, Si, 45°
022-4050	HATR Flow-Through Cell, Ge, 45°
022-4052	HATR Flow-Through Cell, Ge, 45°, 2 mm
022-5228	HATR Flow-Through Cell with UV Port, AMTIR, 45°

Notes: HATR flow-through cells include Luer-Lok fittings for easy connection with a syringe. A set of 1/16" Swagelok fittings are also included with each flow-through cell. Flow-through cell volume is 500 µL. PTFE-coated flow-through cells available – contact us for more information.

LIQUID JACKETED CRYSTAL PLATES FOR HATR AND HATRPLUS

PART NUMBER	DESCRIPTION
022-5310	HATR Liquid Jacketed Trough Plate, ZnSe, 45°
022-5320	HATR Liquid Jacketed Trough Plate, AMTIR, 45°
022-5330	HATR Liquid Jacketed Trough Plate, KRS-5, 45°
022-5340	HATR Liquid Jacketed Trough Plate, Si, 45°
022-5350	HATR Liquid Jacketed Trough Plate, Ge, 45°

Notes: Liquid jacketed crystal plates require customer-provided liquid circulator. Liquid jacketed crystal plates enable heating to 130 °C and cooling. Ge becomes opaque near 100 °C.

LIQUID JACKETED, FLOW-THROUGH CRYSTAL PLATES FOR HATR AND HATRPLUS

PART NUMBER	DESCRIPTION
022-5410	HATR Liquid Jacketed Flow-Through Plate, ZnSe, 45°
022-5412	HATR Liquid Jacketed Flow-Through Plate, ZnSe, 45°, 2mm
022-5420	HATR Liquid Jacketed Flow-Through Plate, AMTIR, 45°
022-5430	HATR Liquid Jacketed Flow-Through Plate, KRS-5, 45°
022-5440	HATR Liquid Jacketed Flow-Through Plate, Si, 45°
022-5450	HATR Liquid Jacketed Flow-Through Plate, Ge, 45°
022-5452	HATR Liquid Jacketed Flow-Through Plate, Ge, 45°, 2 mm

Notes: Liquid jacketed flow-through crystal plates require customer-provided liquid circulator to enable heating to 130 °C and cooling. HATR flow cells include Luer-Lok fittings for easy connection with a syringe and 1/16" Swagelok® fittings. PTFE-coated flow-through cells available – contact us for more information.

HATR RCPLATE

PART NUMBER	DESCRIPTION
022-2300	RCPlate for HATR (for 45° crystals)

Note: Requires a selection of HATR Crystal – see below

HATR AND HATRPLUS REPLACEMENT PARTS

PART NUMBER	DESCRIPTION
022-3051	HATR Volatiles Cover
022-3052	HATR Powder Press
160-5554	Crystal, Trap, ZnSe, 45°, 80 x 10 x 4 mm
160-5559	Crystal, Trap, ZnSe, 45°, 80 x 10 x 2 mm
160-5555	Crystal, Trap, KRS-5, 45°, 80 x 10 x 4 mm
160-5556	Crystal, Trap, Ge, 45°, 80 x 10 x 4 mm
160-5560	Crystal, Trap, Ge, 45°, 80 x 10 x 2 mm
160-5557	Crystal, Trap, AMTIR, 45°, 80 x 10 x 4 mm
160-5558	Crystal, Trap, Si, 45°, 80 x 10 x 4 mm
160-5561	Crystal, Trap, ZnSe, 60°, 80 x 10 x 4 mm
160-5562	Crystal, Trap, Ge, 60°, 80 x 10 x 4 mm
022-3032	Spacer for HATR Flow Cell, 2 mm
022-3040	Viton O-Ring for HATR Flow-Through Cell, upper (6 ea.)
022-3045	Viton O-Ring for HATR Flow-Through Cell, lower (6 ea.)
022-3041	Perfluoroelastomer O-Ring for HATR Flow-Through Cell, upper (1 ea.)
022-3046	Perfluoroelastomer O-Ring for HATR Flow-Through Cell, lower (1 ea.)

Notes: Reconditioning service for used HATR crystal plates is available. Contact PIKE Technologies for items not described in this list.

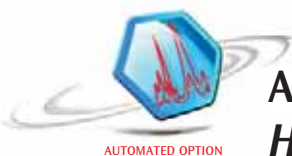

ATRMax II Variable Angle Horizontal ATR Accessory – HATR for Inquisitive Minds



FEATURES

- Selectable angle of incidence – 25 to 65 degrees in one degree increments
- 0.5 to 10 micron depth of penetration – dependent on crystal material, angle of incidence, sample's refractive index and wavelength of IR beam – ideal for depth profiling studies
- 3 to 12 reflections of IR beam – dependent upon angle of incidence – ideal for optimizing ATR sampling methods
- Flat and trough crystal plates for solids, films, powders and liquid samples – optional temperature control for all plates
- Optional, high-pressure clamp for sampling of films, coatings or powdered samples
- Motorized option with electronic control module and AutoPRO™ software for automated, high-precision experiments
- Sealed and purgeable optical design to eliminate water vapor and carbon dioxide interferences

The ATRMax II is a high throughput, variable angle horizontal ATR accessory developed for use in FTIR spectrometers. The design employs a unique optical layout (U.S. patent 5,105,196) which enables samples to be analyzed over a range of incident angles from 25 to 65 degrees. Variable angle of incidence provides experimental control over the depth of penetration of an IR beam into the sample and the number of beam reflections in the ATR crystal, which in turn determines the effective IR beam pathlength for a given experiment. Adjustable angle of incidence allows immediate optimization of measurements for otherwise difficult to analyze samples. The ATRMax can be used for depth profiling studies where spectral composition may be analyzed relative to depth of penetration as the angle of incidence is changed.

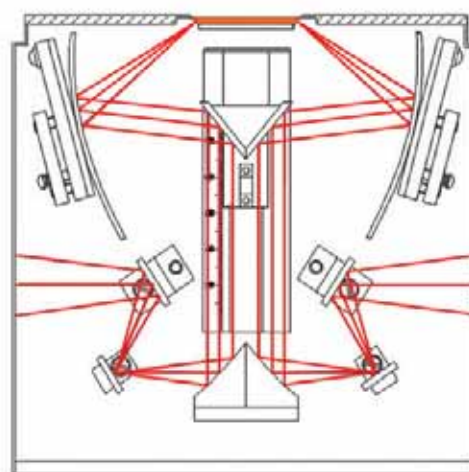

Proprietary beam path within the ATRMax II FTIR sampling accessory.

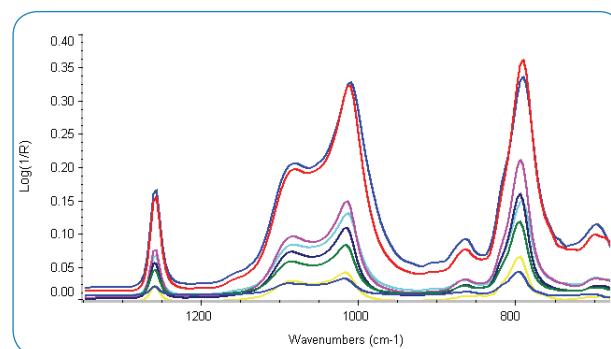

Depth profiling study of silicon release agent using ATRMax II accessory. FTIR spectra collected using Ge crystal flat plates at effective angles of incidence from 25 to 65 degrees.

The ATR crystals for the ATRMax II are of trapezoidal shape and 56-mm long, 10-mm wide and 4-mm thick. Standard bevel angles at each end of the crystal are available in 30, 45, and 60 degree versions. Coupling the variable angle of incidence of the ATRMax II with the variable crystal face angles, one can select effective angle of incidence ranging from 25 to 65 degrees and the range in number of reflections from 3 to 12.

Two crystal plate configurations, flat and trough, are available for the ATRMax II. The **flat crystal plate** design is used for the analysis of coatings, films and non-particulate solids. Typical applications include depth profiling studies and optimization of ATR spectral data. A sample clamp is required to provide intimate contact between the sample and crystal surface.

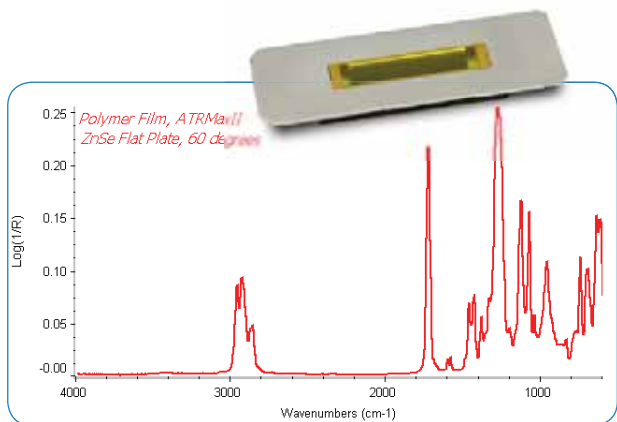

Optimized FTIR spectrum of polymer film run with the ATRMax II at 60 degree angle of incidence.

The **trough crystal plate** is recommended for use with liquids, pastes and powdered samples. Typical applications include the analysis of oils, detergents, and other liquid samples. A volatiles cover and powder press are included with the ATRMax II for use with this crystal plate style.

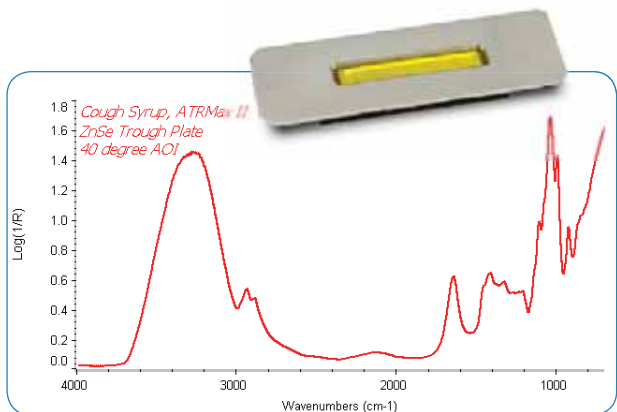

Liquid cough syrup sample spectrum collected with the ATRMax II accessory using the ZnSe trough plate and a 40 degree angle of incidence.

For special applications where you need to look at coatings on an ATR crystal, PIKE Technologies offers the RCPlate™ option. The RCPlate is designed to enable easy removal and reinsertion of the ATR crystal. Applications include analysis of coatings, monomolecular layers, or bio-films deposited directly upon the ATR crystal. With these RCPlates, it is easy to collect the background spectrum on the clean crystal, remove the ATR crystal from the RCPlate, coat the crystal and then reposition it into the RCPlate to collect the sample spectrum.



A variety of **flow-through cells** are available which feature removable crystals. This enables replacement of the crystals and facilitates cleaning of “sticky” samples. Flow cells may be configured for ambient measurements and heating and liquid jacketed temperature control. With the liquid-jacketed version one can measure samples at heated or cooled temperatures using a liquid circulator. PTFE coating of the cell is an option.



Optional **resistively heated crystal plates** are available for the ATRMax II trough, flat and flow-through cell versions. These heated crystal plates are driven using PIKE Technologies temperature controllers available in digital and digital PC versions. The digital PC version offers PIKE TempPRO software for graphical setup and interfaces with most FTIR software packages for data collection.



The variable angle of incidence can be controlled manually or with an optional **motorized attachment** for the ATRMax II. Multiple ATR measurements at different angles of incidence can be fully automated with the motorized version and PIKE Technologies AutoPRO software. Automation streamlines the collection of spectra from multiple angles of incidence. With the automated ATRMax accessory, the entire experiment can be pre-programmed and executed by the computer. Advantages of the automated ATRMax II system include:

- Computer controlled precision, accuracy and repeatability
- Synchronization of mirror position changes with collection of sample spectra
- Full integration of the PIKE Technologies AutoPRO software with most FTIR spectrometer programs
- Tailor-made, predefined experiments
- “Hands-free” operation



AutoPRO Software control of ATRMax angle of incidence (automated polarizer available) for automated depth profiling studies and ATR experiment optimization.

ORDERING INFORMATION

ATRMMax II SYSTEM CONFIGURATIONS

PART NUMBER	DESCRIPTION
023-10XX	ATRMMax II Trough Plate System with 45° ZnSe Crystal <i>Includes Trough Plate, Volatiles Cover and Powder Press</i>
023-11XX	ATRMMax II Flat Plate System with 45° ZnSe Crystal <i>Includes Flat Plate and Pressure Clamp</i>
023-12XX	ATRMMax II Combined Trough and Flat Plate System with 45° ZnSe Crystals <i>Includes Trough Plate, Flat Plate, Volatiles Cover, Powder Press and Pressure Clamp</i>

Notes: Replace **XX** with your spectrometer's Instrument Code. [Click for List >](#)
 ATRMax II Systems may be purchased with crystal plates other than ZnSe.
 Just add -Ge for germanium, -KR for KRS-5, -AM for AMTIR, or -Si for Silicon.
 Additional plates can be added to an order for any system above. Other configurations may be selected from the options below.

ATRMMax II BASE OPTICS (must select)

PART NUMBER	DESCRIPTION
023-19XX	ATRMMax II Variable Angle HATR

Notes: Replace **XX** with your spectrometer's Instrument Code. [Click for List >](#)
 ATRMax II Base Optics includes volatiles cover, powder press, purge tubes, purge kit and spectrometer base mount.

CRYSTAL PLATES FOR ATRMAX II (must select 1 or more)

PART NUMBER	DESCRIPTION
023-2001	Trough Plate, ZnSe, 45°
023-2011	Flat Plate, ZnSe, 45°
023-2021	Trough Plate, ZnSe, 30°
023-2031	Flat Plate, ZnSe, 30°
023-2041	Trough Plate, ZnSe, 60°
023-2051	Flat Plate, ZnSe, 60°
023-2003	Trough Plate, Ge, 45°
023-2013	Flat Plate, Ge, 45°
023-2023	Trough Plate, Ge, 30°
023-2033	Flat Plate, Ge, 30°
023-2043	Trough Plate, Ge, 60°
023-2053	Flat Plate, Ge, 60°
023-2046	Trough Plate, AMTIR, 45°
023-2047	Flat Plate, AMTIR, 45°
023-2002	Trough Plate, KRS-5, 45°
023-2012	Flat Plate, KRS-5, 45°
023-2022	Trough Plate, KRS-5, 30°
023-2032	Flat Plate, KRS-5, 30°
023-2042	Trough Plate, KRS-5, 60°
023-2052	Flat Plate, KRS-5, 60°
023-2044	Trough Plate, Si, 45°
023-2045	Flat Plate, Si, 45°

Notes: ATRMax crystal plates are pre-aligned and pinned-in-place. Changing crystal plates is easy and fast to optimize sampling results. If you need a crystal plate not listed here, please contact us.

PRESSURE CLAMP FOR ATRMAX II

PART NUMBER	DESCRIPTION
023-3050	ATRMMax Pressure Clamp

Note: The pressure clamp is required for solids, films, coatings and powdered samples.

ATRMMax II SAMPLING OPTIONS

PART NUMBER	DESCRIPTION
023-2800	Motorized Upgrade for ATRMax II
023-2850	Motorized Option for ATRMax II
090-1000	Manual Polarizer, ZnSe
090-5000	Precision Automated Polarizer, ZnSe, USB
023-2300	RCPlate for ATRMax II
023-4000	ATRMMax Flow Cell Assembly (order crystal separately)
023-4100	ATRMMax Liquid-Jacketed Flow-Through Cell Assembly (order crystal separately)
023-4200	ATRMMax Heated Flow-Through Cell Assembly (order crystal separately)
023-4300	ATRMMax Heated Trough Plate Assembly (order crystal separately)
023-4400	ATRMMax Heated Flat Plate Assembly (order crystal separately)
013-4200	ATR Variable Angle Heating Conversion Plate
076-1420	Digital Temperature Control Module, PC Control
076-1220	Digital Temperature Control Module

Notes: Motorized Option includes PIKE Technologies AutoPRO software and controller. Other polarizer options are found in the polarization section of this catalog. The ATR Variable Angle Heating Conversion Plate must be selected with temperature controlled crystal plates. Resistively heated crystal plates require selection of the Temperature Control Module. Maximum crystal temperature is 120 °C.

CRYSTALS FOR ATRMAX II

PART NUMBER	DESCRIPTION
160-5563	Crystal, 45°, Trap., 56 x 10 x 4, ZnSe
160-5571	Crystal, 60°, Trap., 56 x 10 x 4, ZnSe
160-5569	Crystal, 30°, Trap., 56 x 10 x 4, Ge
160-5565	Crystal, 45°, Trap., 56 x 10 x 4, Ge
160-5573	Crystal, 60°, Trap., 56 x 10 x 4, Ge
160-5570	Crystal, 30°, Trap., 56 x 10 x 4, Si
160-5567	Crystal, 45°, Trap., 56 x 10 x 4, Si
160-5575	Crystal, 60°, Trap., 56 x 10 x 4, Si
160-5566	Crystal, 45°, Trap., 56 x 10 x 4, AMTIR
160-5574	Crystal, 60°, Trap., 56 x 10 x 4, AMTIR

Note: Please contact PIKE Technologies for crystals not on this list.

ATRMMax II REPLACEMENT PARTS

PART NUMBER	DESCRIPTION
023-3051	ATRMMax II Volatiles Cover
023-3052	ATRMMax II Powder Press

Notes: Please contact PIKE Technologies for items not described in this list. Reconditioning service for used ATRMax crystal plates is available.

RESISTIVELY HEATED PLATES SPECIFICATIONS

Temperature Range	Ambient to 120 °C
Accuracy	+/- 0.5% of set point
Sensor Type	3 wire Pt RTD (low drift, high stability)
Controller	
Digital	+/- 0.5% of set point
Digital PC	+/- 0.5% of set point, graphical setup, up to 100 ramps, USB interface
Input Voltage	100–240 VDC, auto setting, external power supply
Operating Voltage	24 VDC/36 W



VeeMAX III with ATR – Variable Angle, Single Reflection ATR for Depth Profiling Studies



The VeeMAX III with ATR offers continuous variable angle of incidence and a variety of crystal plates to selectively control the depth of penetration of the IR beam into the sample. ATR applications include the study of layered samples, coatings, release agents, monolayers on silicon and chemical migration studies.

The VeeMAX III with ATR accessory provides exceptionally high throughput (over 50% with 45 degree ZnSe crystal) to minimize sampling time and enable detection of low concentration components in samples of complex composition. The crystal flat plates offered for the VeeMAX III are ideal for solid and layered samples and are designed for use with the optional pressure clamp. The combination of large crystal diameter (20 mm) and slip-clutch pressure clamp provides sample-to-crystal contact without altering layered sample composition. The optional liquids retainer may be added to the crystal plate for analysis of liquid samples.

FEATURES

- Continuously variable set angle – 30 to 80 degrees
- 0.4 to 46 micron depth of penetration – ideal for depth profiling studies
- High throughput for excellent quality spectra
- Optional, high-pressure clamp for sampling of films, coatings or powdered samples
- Integrated position for manual or automated polarizer
- Motorized option with electronic control module and AutoPRO software for automated, high-precision experiments
- VeeMAX III can be used as a variable angle of incidence specular reflection accessory
- Configurable for specialized applications – monolayer studies and spectroelectrochemistry
- Sealed and purgeable optical design to eliminate water vapor and carbon dioxide interferences

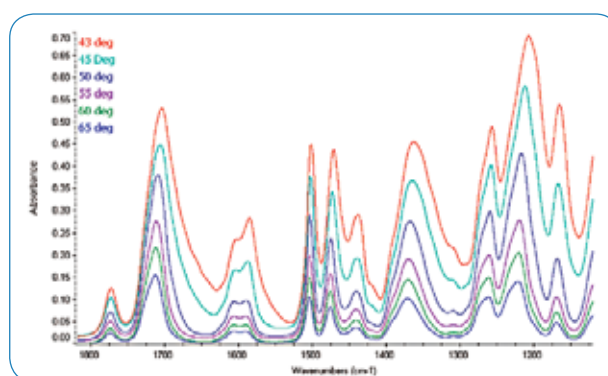

Depth profiling study of layered polymer film. FTIR spectra collected using ZnSe crystal at set angles of incidence from 43 to 65 degrees. IR absorbance band at 1591 cm^{-1} clearly increases relative to other bands as we probe deeper into the sample.

Monolayers and ultra-thin films absorbed on silicon or gold substrate are easily sampled using the VeeMAX III equipped with a high refractive index ATR crystal. Compared to specular reflectance sampling for monolayer analysis, an increase in sensitivity of up to 1–2 orders of magnitude may be realized via ATR sampling. For these applications, the VeeMAX III accessory is configured to include a high-angle Ge flat plate (60 or 65 degrees), the high-pressure clamp with a 7.8-mm pressure tip, and a polarizer.

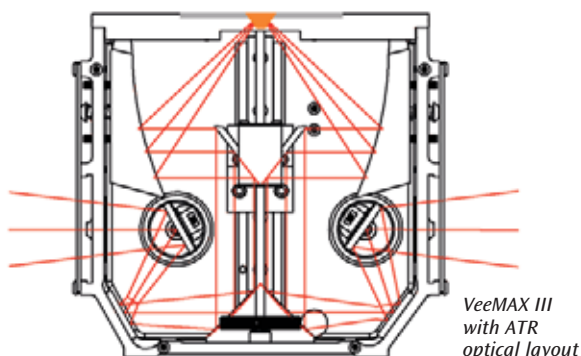

VeeMAX III with ATR optical layout

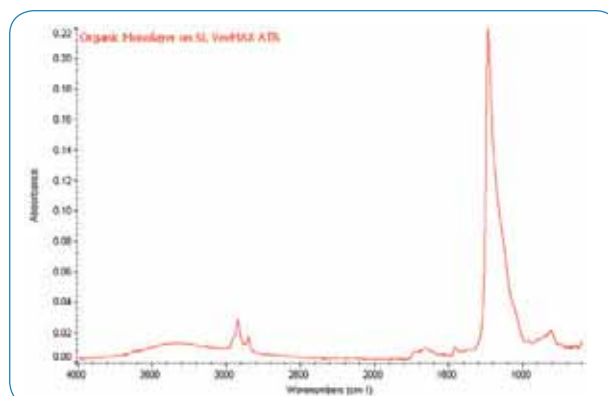

Analysis of monomolecular layer on silicon – VeeMAX III with 60 degree Ge crystal, pressure clamp with 7.8-mm tip and p polarization.

A spectroelectrochemical cell option for the VeeMAX III is also available. The innovative design offers a chemical-resistant vessel sealed to an ATR crystal using an O-ring. The assembly is mounted on the VeeMAX III. The crystals are interchangeable for optimizing spectral results and are removable to allow electrode coating on the ATR surface. The high throughput of the VeeMAX III with ATR provides excellent sensitivity and reduced sampling time. Alternatively, a flat IR transparent window or 60 degree CaF₂ prism may be installed to permit specular reflection sampling. The electrochemistry cell is equipped with a precision micrometer for electrode positioning, and is user-configurable.



Spectroelectrochemical cell mounted on the VeeMAX III.



VeeMAX III spectroelectrochemical cell – maximum flexibility with its interchangeable and removable crystals.

Temperature controlled crystal flat plates are available for thermal studies. The maximum temperature is 130 °C for all crystal types. PIKE Technologies' PC version temperature controller allows up to 100 ramps to be easily programmed using PIKE TempPRO software, and data collection as a function of time or temperature may be prescribed for most FTIR spectrometers.



TempPRO software for graphical setup and control of kinetic measurements.

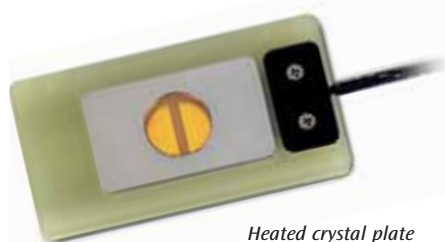

Heated crystal plate

Motorized control of angle of incidence via personal computer is available for the accessory. AutoPRO control software interfaces with FTIR software packages for automated data collection. The Automated VeeMAX III is ideal for depth of profiling studies as it greatly speeds and improves the precision and reproducibility of the data collection process.



SEE IT IN ACTION!



AutoPRO Software (left) configured for the Automated VeeMAX III (shown above with polarizer option) for automated depth profiling studies.

Angle of incidence and polarization angle can be set independently.

VEEMAX III WITH ATR SPECIFICATIONS

ATR Crystal Choice	ZnSe, Ge, Si, ZnS
Crystal Plate Mounting	User-changeable plates
Crystal Plate Mounts	Stainless Steel
Crystal Dimension (surface)	20-mm diameter
Optics	All reflective
Pressure Device	Rotating, continuous variable pressure; click stop at maximum
Heating Options	130 °C
Accuracy	+/- 0.5% of set point
Sensor Type	3 wire Pt RTD (low drift, high stability)
Temperature Control	Digital or digital with PC control (up to 20 ramps, automated data collection, USB interface)
Input Voltage	100–240 VAC, auto setting, external power supply
Operating Voltage	24 VDC/50 W
Purge Sealing	Purge tubes and purge barb included
Accessory Dimensions (W x D x H)	177 x 92 x 162 mm (excludes clamp height and baseplate)
Spectroelectrochemical Vessel Dimensions	25 mm dia tapering to 19 mm, 25 mm tall
Spectroelectrochemical Vessel Volume	7.5 mL
Spectroelectrochemical Vessel Material	Polytetrafluoroethylene or PEEK
FTIR Compatibility	Most, specify model and type

ORDERING INFORMATION

VEEMAX III BASE OPTICS (must select)

PART NUMBER	DESCRIPTION
013-11XX	VeeMAX III Variable Angle Specular Reflectance Accessory <i>Includes specular reflectance masks (2, 5/8 and 3/8"), purge tubes, purge kit and spectrometer base mount.</i>
013-12XX	Automated VeeMAX III <i>Includes controller, cabling, sample masks (2", 5/8" and 3/8"), gold substrate alignment mirror, FTIR base mount, and purge tubes</i>

Note: Replace XX with your spectrometer's Instrument Code. [Click for List >](#)

CRYSTAL PLATES FOR VEEMAX III ATR

(must select 1 or more for ATR)

PART NUMBER	DESCRIPTION
013-4021	Flat Plate, ZnSe, 45°
013-4031	Flat Plate, ZnSe, 60°
013-4041	Flat Plate, Ge, 45°
013-4051	Flat Plate, Ge, 60°
013-4061	Flat Plate, Ge, 65°
013-4081	Flat Plate, Si, 45°
013-4071	Flat Plate, Si, 60°
013-4091	Flat Plate, ZnS, 45°
013-4096	Flat Plate, ZnS, 60°
013-3401	Liquids Retainer for VeeMAX III ATR crystals
013-3501	VeeMAX III ATR Flow Cell

Notes: VeeMAX III Crystal Plates are pre-aligned and pinned-in-place. Changing crystal plates is easy and fast to optimize sampling results. ZnS crystal plate is excellent for deepest penetration of IR beam. If you need a crystal not listed here, please contact us. Flow cell and Liquids Retainer require High-Pressure Clamp. Reconditioning service for used VeeMAX crystal plates is available.

OPTIONAL CRYSTAL PLATES FOR HEATED VEEMAX III ATR

PART NUMBER	DESCRIPTION
013-4121	Heated Flat Plate, ZnSe, 45°
013-4131	Heated Flat Plate, ZnSe, 60°
013-4141	Heated Flat Plate, Ge, 45°
013-4151	Heated Flat Plate, Ge, 60°
013-4161	Heated Flat Plate, Ge, 65°
013-4171	Heated Flat Plate, Si, 60°
013-4181	Heated Flat Plate, Si, 45°
013-4191	Heated Flat Plate, ZnS, 45°
013-4196	Heated Flat Plate, ZnS, 60°
076-1220	Digital Temperature Control Module
076-1420	Digital Temperature Control Module, PC Control

Notes: Heated VeeMAX III crystal plates may be heated to 130 °C. Temperature control module selection is required for heated crystal plates. Digital temperature control module with PC control includes TempPRO software.

PRESSURE CLAMP FOR VEEMAX III (must select for solids, films or powder analysis)

PART NUMBER	DESCRIPTION
013-3101	VeeMAX III ATR Pressure Clamp
025-3094	7.8-mm ATR Pressure Tip

Notes: The pressure clamp is required for solids, films, coatings and powdered samples. The pressure clamp is supplied with 20-mm tip for solid samples. The 7.8-mm pressure tip is required for monolayers on silicon or small samples.

VEEMAX III SAMPLING OPTIONS

PART NUMBER	DESCRIPTION
090-1000	Manual Polarizer, ZnSe
090-1200	Manual Polarizer, KRS-5
090-3000	Precision Manual Polarizer, ZnSe
090-3200	Precision Manual Polarizer, KRS-5
090-5000	Precision Automated Polarizer, ZnSe, USB
090-5100	Precision Automated Polarizer, KRS-5, USB
007-0300	PIKECalc Software

Notes: PIKECalc software provides easy calculations of depth of penetration, effective angle of incidence and critical angle for ATR measurements. Automated option includes PIKE Technologies AutoPRO software and controller. Other polarizer options are found in the polarization section of this catalog. Automated VeeMAX III and automated polarizer interface simultaneously.

SPECTROELECTROCHEMICAL CONFIGURATION

PART NUMBER	DESCRIPTION
013-3300	Electrochemical Cell, PTFE
013-3370	Electrochemical Cell, PEEK
013-3402	Heated Electrochemical Cell, PTFE
160-5546	ZnSe Crystal, 45°
160-5550	ZnSe Crystal, 60°
160-5547	Ge Crystal, 45°
160-5551	Ge Crystal, 60°
160-5548	Si Crystal, 45°
160-5552	Si Crystal, 60°
160-5549	ZnS Crystal, 45°
160-5553	ZnS Crystal, 60°
160-5527	CaF ₂ Crystal, 60°
160-1144	CaF ₂ Flat Window, 20-mm diameter
160-1304	ZnSe Flat Window, 20-mm diameter
013-3320	Flat Window Holder, Delrin™
013-3345	45° Crystal Holder, Delrin
013-3360	60° Crystal Holder, Delrin
013-3374	45° Crystal Holder, PEEK
013-3376	60° Crystal Holder, PEEK
013-3445	Heated 45° Crystal Holder
013-3460	Heated 60° Crystal Holder

Notes: The electrochemical configuration requires electrochemical cell, crystal or window holder and VeeMAX III accessory. Must select one or more crystal or flat window. Choose a crystal holder to match the crystal angle. A flat window or CaF₂ crystal are used for specular reflectance sampling. Other window types for specular reflectance measurements may be found in our listing of transmission windows, 20 mm x 2 mm. The heated electrochemical cell requires the choice of a digital temperature controller. Electrodes supplied by the end-user.

REPLACEMENT PARTS

PART NUMBER	DESCRIPTION
013-4010	Mask Set for VeeMAX
300-0002	Gold Substrate Alignment Mirror, 1.25 x 3.0"



AutoATR – An Innovative Breakthrough in Automated ATR Sampling



FEATURES

- Complete hardware and software package for automated ATR analysis
- Up to 24 unique ATR measurements in a single run
- Spectra comparable to a single reflection ZnSe or diamond ATR
- Removable and replacement ATR elements
- Fully enclosed, purgeable design with front-loading tray
- In-compartment mounting, compatible with most FTIR spectrometers

The development of an automated attenuated total reflection (ATR) accessory on a non-micro scale has been elusive despite ATR being the most popular mid-IR sampling technique due to its ease-of-use and small fixed pathlength. The primary advantage of FTIR-ATR measurements is minimal sample preparation. However, cleaning of the ATR crystal after every measurement is mandatory and has hindered the development of a commercial automated ATR in the past. With new innovations these challenges have been met and the advantages of automation are realized with the introduction of the AutoATR by PIKE Technologies. This new sampling accessory greatly enhances productivity of large-scale studies and facilitates routine measurements for high-throughput labs. The accessory is suitable for making ATR measurements of liquids, gels, pastes, casted films and more.

The AutoATR merges an exciting new ATR crystal developed via microtechnology with a microtiter plate platform offering precision mechanics and automated software control. Using a 24-well microtiter plate format enables 24 unique ATR measurements to be conducted within one run. At the heart of this accessory is a single reflection ATR crystal made from 500- μm thick silicon functionalized with multiple microprisms, which couples the light into the crystal. The dimensions of an individual crystal are 9 mm x 11 mm; the ATR active area is 7 mm x 9 mm. Each 24-well plate consists of 24 individual and removable Si ATR crystals.

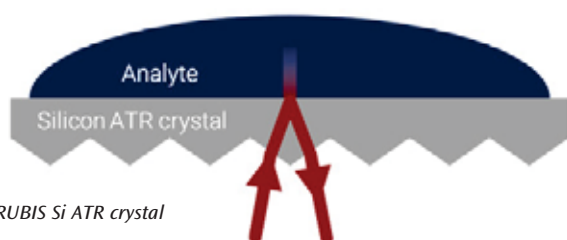

IRUBIS Si ATR crystal

Silicon, in this thin 500- μm form, is an ideal multipurpose ATR element. It has an extremely inert sampling surface and is suitable for use with substances having a pH between 1-12. The changeable ATR crystals also offer the opportunity to store the samples and to prepare different samples at the same time (i.e. drying). In addition, the plain silicon surface may be functionalized outside the microplate, because the crystals are removable and interchangeable.

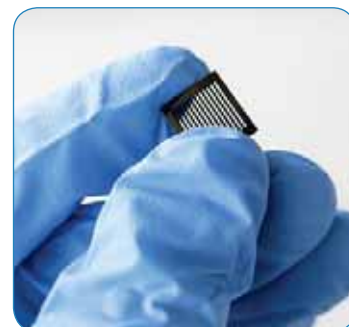

For traditional Si ATR crystals, the beam pathlength through the crystal is several millimeters in some cases, which results in complete absorption of the Si phonon bands in the fingerprint region (1500 – 400 cm^{-1}). The beam pathlength through the thin profile of Si ATR element minimizes absorption from Si phonon bands and offers a full mid-IR spectral range (5000 – 400 cm^{-1}). The absorbance and penetration depth are comparable to a standard diamond ATR. The figure below shows spectra of oil collected using the AutoATR versus a single reflection diamond ATR. Absorbance band position, shape and magnitude are very similar. The efficiency of the accessory's delivery optics and Si ATR element coupled with several microprisms results in high energy throughput and reproducibility. Thus, high-quality spectra may be collected over a short time period.

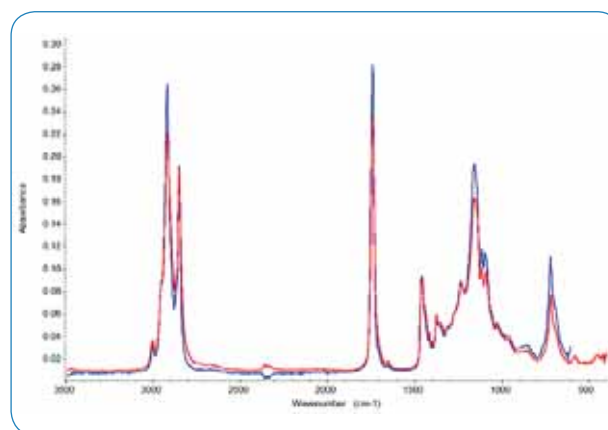

Spectra of oil collected using the AutoATR (red) and a single reflection diamond ATR (blue).

The AutoATR is designed to fit into the sample compartment of most FTIR spectrometers. Its X,Y tray moves to a position outside the accessory for easy loading and unloading of samples while maintaining purge. The stage is driven by precision servo motors with optical encoders for speed and reproducibility. USB and DC power are the only external connections required. The optical design is based upon a precision ellipsoidal reflector, which has been diamond turned for optimal performance. The optics demagnify the beam to a size that fills the active ATR area.

The accessory's control software, AutoPRO, plays an integral role in its usability and value. Data collection is enabled through communication with most FTIR software programs. It allows for traceability by facilitating multiple users. Sample descriptions may be entered manually or uploaded from a spreadsheet; sample information is stored with the spectral file. For ease of file finding, the program offers numerous file naming schemes such as time stamp or unique file prefix naming. It also incorporates options for calling macros to execute post-processing commands such as peak picking, report generation and exporting data to a spreadsheet format.

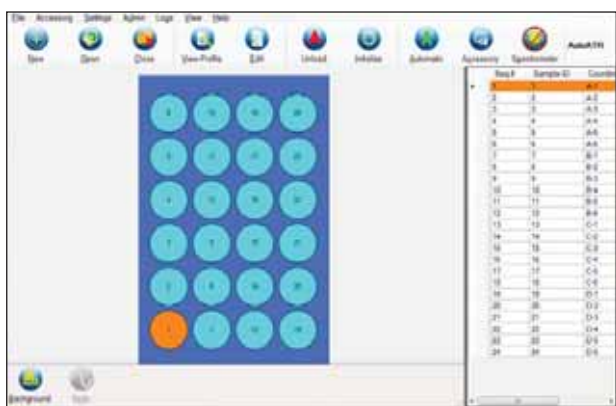

PIKE AutoPRO software configured for the AutoATR accessory.

The AutoATR high-throughput accessory is ideal for comprehensive larger studies. Fields of biology, medical, pharmaceutical and food could benefit from an automated ATR. Additionally, there are ongoing efforts to transfer infrared spectroscopy from academic research into clinics. An automated ATR high-throughput device fulfills this requirement and enables larger studies, while increasing lab efficiency and minimizing workforce requirements, and also is suitable for the high throughput lab conducting routine measurements.

SPECIFICATIONS	
Optics	Elliptical – 3X beam demagnification
Accuracy	+/- 25 μ m
Mechanical Specifications	
Repeatability	+/- 5 μ m
Resolution	1 μ m
Minimum Run Time	56 seconds for 24-well plate (actual time is spectrometer and application dependent)
Computer Interface	USB
Dimensions (W x D x H)	6.25 x 13.2 x 5.55" (including micrometer)
Weight	10 lbs

ORDERING INFORMATION

PART NUMBER	DESCRIPTION
047-25XX	AutoATR Includes AutoPRO software, 24-well ATR plate with ATR elements

Notes: Replace XX with your spectrometer's Instrument Code. [Click for List >](#)

REPLACEMENT PARTS AND OPTIONS

PART NUMBER	DESCRIPTION
162-4810	AutoATR 24-well Plate with ATR Elements
162-4812	AutoATR 12-well Plate with ATR Elements
162-4814	AutoATR Replacement ATR Elements (2 ea.)

JetStream ATR Accessory – Measurements of Liquids under Varying Conditions



FEATURES

- Efficient ATR design for static and flowing liquid measurements
- Small sample chamber provides efficient sampling
- ZnSe and Germanium crystal options to match sample requirements
- Qualitative and quantitative applications
- Temperature control option up to 200 °C
- Pressures up to 1500 psi

The PIKE Technologies JetStream is a unique ATR accessory optimized for analysis of liquids in static or flow modes at varying pressure. The accessory design revolves around a cylindrical ATR crystal that is encased in a heavy-duty stainless steel body. The sample is introduced via a compression filling from 1/16" up to 1/4" tube OD and completely surrounds the ATR crystal providing efficient sampling for excellent reproducibility and sufficient throughput for high sensitivity measurements. The maximum pressure rating is 1500 psi.

The compact cell design employs a pair of transfer optics to direct the infrared beam to one end of an IR transmitting ATR crystal. A similar pair of optics directs the beam emitted from the other end of the ATR crystal to the spectrometer detector.

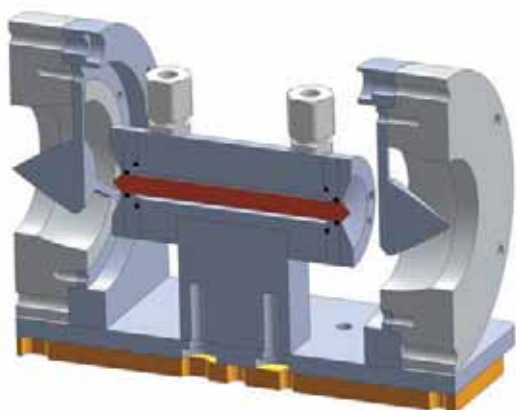

Optical diagram of the JetStream ATR

The ATR crystal for the JetStream ATR accessory is of a cylindrical shape and is 82-mm long and 6.4-mm in diameter. To optimize accessory performance, crystal geometry has been carefully chosen. The design of the JetStream ATR accessory provides 12 reflections of the IR beam along the crystal surface. The volume of the sample chamber is 1.3 mL.

Heating up to 200 °C may be realized with the heated JetStream base. PIKE Technologies offers digital and PC programmable temperature controllers. Ramps and hold times are easily programmed through TempPRO software when using the PC module. Data collection may be initiated as a function of time or temperature with many FTIR spectrometers.



Heated JetStream accessory



Selection of the digital control module, PC control includes PIKE TempPRO™ software for graphical setup and automated data collection for thermal experiments.

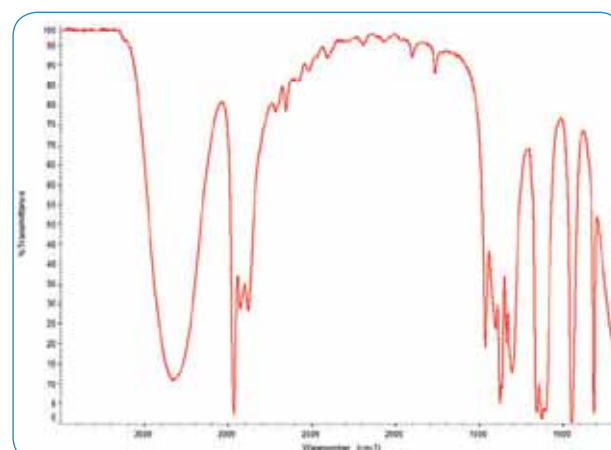

Isopropanol spectrum collected using the JetStream with ZnSe crystal.

ORDERING INFORMATION

PART NUMBER	DESCRIPTION
020-19XX	JetStream ATR Base Optics Assembly
020-18XX	Heated JetStream ATR Base Optics Assembly

Notes: Replace XX with your spectrometer's Instrument Code. [Click for List >](#)
 Choose a temperature controller below for the Heated JetStream. Ge becomes opaque near 100 °C. 1/4 inch compression fittings are supplied. Contact us for other fitting sizes.

ATR CRYSTALS FOR JETSTREAM (must select one)

PART NUMBER	DESCRIPTION
160-5578	ZnSe Rod
160-5579	Ge Rod

TEMPERATURE CONTROLLER FOR JETSTREAM

PART NUMBER	DESCRIPTION
076-1220	Digital Temperature Control Module
076-1420	Digital Temperature Control Module, PC Control

REPLACEMENT PARTS

PART NUMBER	DESCRIPTION
020-3040	EPDM Crystal O-Rings, 120 °C max (2 ea.)
020-3041	EPDM Housing O-Rings, 120 °C max (2 ea.)
020-3045	Perfluoroelastomer Crystal O-Rings (2 ea.)
020-3046	Perfluoroelastomer Housing O-Rings (2 ea.)

SPECIFICATIONS

Cell Body	316 Stainless Steel
ATR Crystals	ZnSe or Germanium
Crystal Size	82 mm x 6.4 mm
Crystal Face Angle	45°
Number of Reflections	12
Cell Volume	1.3 mL
Liquid Connectors	316 Stainless Steel Swagelok®
Maximum Pressure	1500 psi
Heating Options	Ambient to 200 °C maximum
Accuracy	+/- 0.5% of set point
Sensor Type	3 wire Pt RTD (low drift, high stability)
Temperature Control	Digital or digital with PC control (up to 100 ramps, automated data collection, USB interface)
Input Voltage	100–240 VAC, auto setting, external power supply
Operating Voltage	3 A/24 VDC/75 W
Accessory Dimensions (W x D x H)	153 x 100 x 108 mm (excludes FTIR baseplate and mount)
FTIR Compatibility	Most, specify model and type

Classic VATR – Variable Angle ATR for Analysis of Solids, Films and Coatings



FEATURES

- 30 to 60 degree – continuously variable angle of incidence
- Full control over the number of reflections and depth of penetration
- Unique mechanism for fine-tuning mirror positions and precise and repeatable alignment
- High energy throughput
- Stainless steel, easy to remove crystal mounts and anvils
- Economical introduction to ATR techniques – excellent R&D and teaching tool

The Variable Angle ATR is a traditional in-compartment accessory with the ATR crystal mounted vertically with respect to the spectrometer baseplate. Its optical layout is based on an optimized Gilby configuration and allows continuous adjustment of the incident beam angle between 30 to 60 degrees. This accessory is suitable for the analysis of solids, films and coatings, but for obvious reasons, it cannot be used for working with liquids. For enhanced sensitivity the sample may be mounted on both sides of the crystal. A unique mirror adjustment mechanism which utilizes mirror placement and proportional pivoting allows precise and repeatable alignment. PIKE Technologies' Variable Angle ATR offers flexibility when the frequent replacement of ATR crystals is required. VATR is an excellent, low-cost tool for teaching the principles of internal reflection spectroscopy, and for basic research.

ORDERING INFORMATION

VATR BASE OPTICS (must select)

PART NUMBER	DESCRIPTION
021-19XX	VATR Variable Angle, Vertical ATR

Notes: Replace **XX** with your spectrometer's Instrument Code. [Click for List >](#)
VATR Base Optics includes plate for mounting in FTIR spectrometer slide mount.

CRYSTAL OPTIONS FOR VATR (must select 1 or more)

PART NUMBERS		DESCRIPTION
P/N 50 MM	P/N 25 MM	
160-5528	160-5530	KRS-5, 45° Parallelogram
160-5529	160-5531	KRS-5, 60° Parallelogram
160-5532	160-5533	ZnSe, 45° Parallelogram
160-5543	160-5540	ZnSe, 60° Parallelogram
160-5541	160-5538	Ge, 30° Parallelogram
160-5534	160-5536	Ge, 45° Parallelogram
160-5535	160-5537	Ge, 60° Parallelogram
160-5544	160-5539	Si, 45° Parallelogram

Notes: VATR crystals are available in lengths of 25 and 50 mm. All are 3-mm thick and 10-mm wide. Select crystal length and type based upon desired sample absorbance and spectral range.

CRYSTAL HOLDER AND CLAMP FOR VATR

(must select 1 or more to hold ATR crystals)

PART NUMBER	DESCRIPTION
021-5050	50-mm VATR Crystal Holder and Clamp
021-5020	25-mm VATR Crystal Holder, Clamp and Mirror

Note: The pressure clamp is selected for the ATR crystal length.

VATR REPLACEMENT PARTS

PART NUMBER	DESCRIPTION
021-5040	25-mm VATR Crystal Holder and Clamp
021-5030	Set of 25-mm and 50-mm Pads

Note: Please contact PIKE Technologies for items not described in this list.

ATR – Theory and Applications

Attenuated Total Reflectance (ATR) is today the most widely used FTIR sampling tool. ATR generally allows qualitative or quantitative analysis of samples with little or no sample preparation, which greatly speeds sample analysis. The main benefit of ATR sampling comes from the very thin sampling pathlength and depth of penetration of the IR beam into the sample. This is in contrast to traditional FTIR sampling by transmission where the sample must be diluted with IR transparent salt, pressed into a pellet or pressed to a thin film, prior to analysis to prevent totally absorbing bands in the infrared spectrum.

A comparison of transmission versus ATR sampling results for a thick polymer sample is shown below where the sample is too thick for high-quality transmission analysis (shown in the lower blue spectrum). In transmission spectroscopy, the IR beam passes through the sample and the effective pathlength is determined by the thickness of the sample and its orientation to the directional plane of the IR beam. Clearly in the example below the sample is too thick for transmission analysis because most of the IR bands are totally absorbing. However, simply placing the thick sample on the ATR crystal (Diamond MIRacle) and applying pressure generates a nearly perfect result (upper red spectrum) – identified by a library search as a polybutylene terephthalate. The total analysis time for the thick polymer by ATR was less than 1 minute.

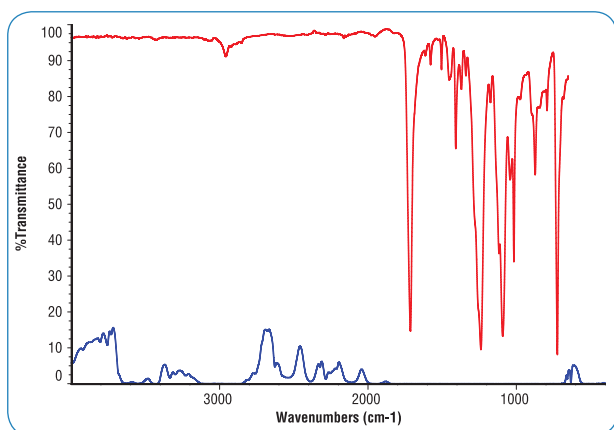

ATR and transmission spectra of a thick polymer sample.

How ATR Works

With ATR sampling we direct the IR beam into a crystal of relatively higher refractive index. The IR beam reflects from the internal surface of the crystal and creates an evanescent wave, which projects orthogonally into the sample in intimate contact with the ATR crystal. Some of the energy of the evanescent wave is absorbed by the sample and the reflected radiation is returned to the detector. This ATR phenomenon is shown graphically in the following representation of a single reflection ATR.

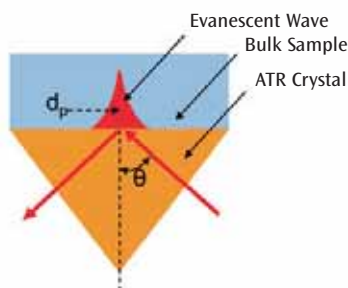

Graphical representation of a single reflection ATR.

While the analysis of samples by ATR is easy, it is interesting and useful to be aware of each of the following experimental factors and how they affect the final spectrum:

- Refractive indices of the ATR crystal and the sample
- Angle of incidence of the IR beam
- Critical angle
- Depth of penetration
- Wavelength of the IR beam
- Effective pathlength
- Number of reflections
- Quality of the sample contact with ATR crystal
- ATR crystal characteristics

The **refractive indices of the crystal and sample** are important considerations in the ATR sampling technique by virtue of the following equation:

$$\theta_c = \sin^{-1} \left(\frac{n_2}{n_1} \right)$$

where θ_c is the **critical angle**, n_2 is the refractive index of the sample and n_1 is the refractive index of the crystal.

When the angle of incidence exceeds the critical angle, we will observe a purely ATR spectral result. If the critical angle is not met, we will observe a combined ATR and external reflectance result. This occurs if the angle of incidence of the IR beam is too low, if the refractive index of the crystal is too low, if the refractive index of the sample is too high or a combination of these three factors. In most cases this problem is not observed; however, an example of this is shown in the following spectral data. The sample is a high refractive index liquid ($n_1=1.8$) run on a 45 degree accessory using diamond and Ge crystal plates. The spectrum run on the Ge crystal plate exhibits a normal baseline and symmetric absorbance bands – critical angle is met. The spectrum run on the diamond crystal plate has a baseline shifted and asymmetric absorbance bands due to non-adherence to the critical angle requirements for this set of analysis parameters.

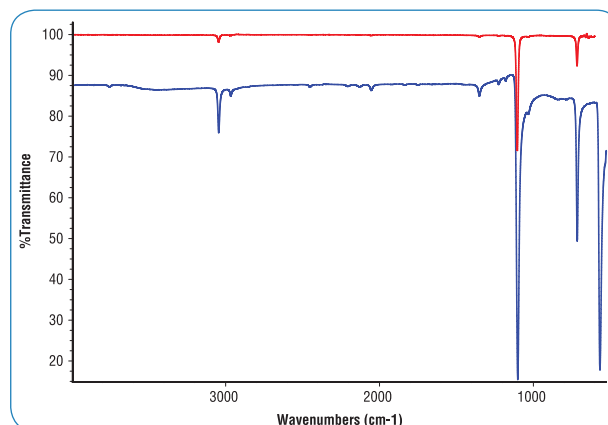

Spectra of high refractive index liquid collected using Ge (red) and diamond (blue) ATR crystals.

Another way to correct the spectral artifacts observed (above) in the high refractive index sample spectrum would be to increase the angle of incidence in the ATR accessory to a value above the critical angle. Adjustment or selection of the angle of incidence is available in several of the PIKE Technologies ATR accessories.

Table 1: Pathlengths and penetration depth (in microns), and ATR crystals at various angles of incidence (in degrees) and numbers of reflections.

ATR Sampling for $n_2 = 1.5$ $\lambda = 1000 \text{ cm}^{-1}$		ZnSe, Diamond $n_1 = 2.4$ $\theta_c = 38.7^\circ$			AMTIR $n_1 = 2.5$ $\theta_c = 36.9^\circ$			Ge $n_1 = 4.0$ $\theta_c = 22.0^\circ$		
θ	N	d_p	d_e	EPL	d_p	d_e	EPL	d_p	d_e	EPL
45	1	2.00	4.36	4.36	1.70	3.38	3.38	0.66	0.61	0.61
45	3	2.00	4.36	13.08	1.70	3.38	10.15	0.66	0.61	1.84
45	10	2.00	4.36	43.60	1.70	3.38	33.84	0.66	0.61	6.14
30	1	N/A	N/A	N/A	N/A	N/A	N/A	1.20	1.59	1.59
30	3	N/A	N/A	N/A	N/A	N/A	N/A	1.20	1.59	4.76
30	10	N/A	N/A	N/A	N/A	N/A	N/A	1.20	1.59	15.85
60	1	1.11	1.53	1.53	1.02	1.30	1.30	0.51	0.32	0.32
60	3	1.11	1.53	4.59	1.02	1.30	3.91	0.51	0.32	0.97
60	10	1.11	1.53	15.32	1.02	1.30	13.03	0.51	0.32	3.23

Note: N/A indicates critical angle is violated.

Further useful consideration for ATR analysis is the **depth of penetration** (d_p) of the IR beam into the sample. Technically, this is defined as the distance required for the electric field amplitude to fall to e^{-1} of its value at the surface and is defined as

$$d_p = \frac{\lambda}{2\pi(n_1^2 \sin^2 \theta - n_2^2)^{1/2}}$$

where λ is the wavelength of light and θ is the angle of incidence of the IR beam relative to a perpendicular from the surface of the crystal. Typical depth of penetration in ATR ranges from about 0.5 microns up to about 5 microns depending upon these experimental conditions. Shown in the graphical representation of the ATR phenomenon, the strength of the evanescent wave decays rapidly as we progress from the surface of the ATR crystal. If we wish to compare the sample absorbance of the ATR measurement with that of a transmission measurement, we need to calculate the volume of the evanescent wave, known as the effective penetration of the IR beam. The effective penetration (d_e), is unique for parallel polarization ($d_{e\parallel}$) and perpendicular polarization ($d_{e\perp}$) and these are defined by:

$$d_{e\perp} = \frac{n_1^2 n_2 \cos \theta}{(n_1^2 - n_2^2)} \times \frac{\lambda_1}{\pi \sqrt{n_1^2 \sin^2 \theta - n_2^2}}$$

$$d_{e\parallel} = \frac{n_1^2 n_2 \cos \theta}{(n_1^2 - n_2^2)} \times \frac{2n_1^2 \sin^2 \theta - n_2^2}{(n_1^2 - n_2^2) \sin^2 \theta - n_2^2} \times \frac{\lambda_1}{\pi \sqrt{n_1^2 \sin^2 \theta - n_2^2}}$$

where $\lambda_1 = \lambda/n_1$

The effective penetration for an unpolarized IR beam is the average of the parallel and perpendicular penetration.

$$d_e = \frac{(d_{e\perp} + d_{e\parallel})}{2}$$

Generally, a single reflection ATR is ideal for qualitative analysis, "what is my sample?" When we need to look at minor components of a sample for qualitative or quantitative analysis, then we need to increase the **effective pathlength** (EPL) by increasing the number of reflections (N) within the ATR crystal. The effective pathlength in ATR is defined by the following equation, where N = number of reflections on the sample.

$$EPL = N \times d_e$$

An example of the benefit of increased number of reflections is shown in the following spectral data for the analysis of carbohydrate content in a soft drink sample. The red spectrum is run using a 10-reflection HATR accessory. The blue spectrum is run using a single-reflection ATR using an identical scaling factor. Clearly the minor carbohydrate bands are more readily apparent in the multi-reflection ATR accessory.

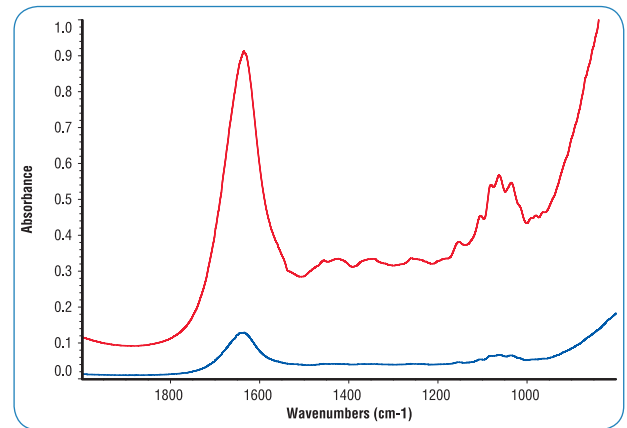

Soft drink sample using 10-reflection (red) and 1-reflection (blue) ATR.

For your convenience we have calculated theoretical values of depth of penetration, effective penetration, and effective pathlength for typical combinations of crystal materials, angles of incidence, and number of reflections (Table 1).

With the thin penetration of the evanescent wave into the sample, it is obvious that intimate contact of the sample be made onto the surface of the ATR crystal. For liquid or pliable samples, **quality of sample contact with the ATR crystal** is generally not a problem. For rigid, irregular shaped or porous samples, high pressure sufficient to deform the sample will increase the extent of sample contact and thereby increase sample absorbance. This is shown in the following spectral data collected for a porous foam polymer using a MIRacle ATR with ZnSe crystal.

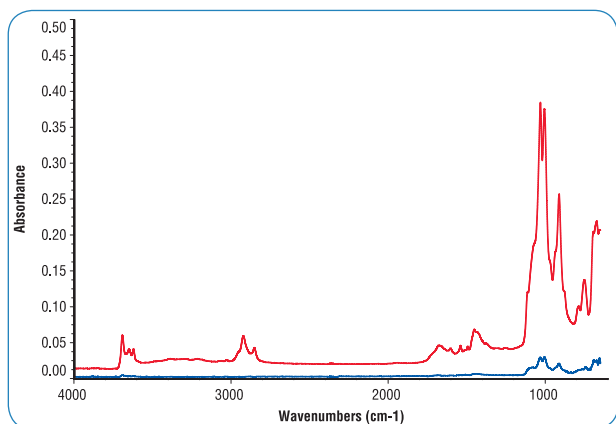

Porous foam sample with high pressure (red) and low pressure (blue).

The blue spectrum was collected with low pressure applied to the foam sample, whereas the red spectrum is produced with high pressure. The ATR absorbance using high pressure is about 10 times greater than with low pressure – all other sampling factors are identical. For rigid, crystalline, or hard, irregular surface samples we recommend a single reflection Diamond MIRacle ATR because it is easy to apply high pressure onto the small crystal (1.8 mm diameter) with the high-pressure clamp, producing over 10,000 psi.

The selection of the **ATR crystal characteristics** should be matched to the type of samples we run. Selection can be made to control depth of penetration of the IR beam, for hardness to prevent crystal damage, for desired spectral range and for acceptable pH range for acid or caustic samples. No individual crystal type will solve all problems, so PIKE Technologies offers a broad range of choices for ATR. Table 2 will give you some guidelines for selection of your ATR crystal.

Table 2: ATR crystal characteristics for FTIR sampling.

Crystal	n_1	d_p , for $n_2 = 1.5$ $\lambda = 1000 \text{ cm}^{-1}$, 45 deg, microns	Water Solubility g/100 g	pH Range	Hardness kgf/mm ²
AMTIR	2.5	1.70	Insoluble	1–9	170
Diamond	2.4	2.01	Insoluble	1–14	5,700
Germanium	4.0	0.66	Insoluble	1–14	550
KRS-5	2.37	2.13	0.05	5–8	40
Silicon	3.4	0.85	Insoluble	1–12	1,150
ZnS	2.2	3.86	Insoluble	5–9	240
ZnSe	2.4	2.01	Insoluble	5–9	120

PIKE Video Library Links — *Video Application Notes and Tips*

Click on the links below to access a wealth of informational videos featuring spectroscopic applications and sampling tips. Topics cover a range of sampling techniques including ATR, diffuse reflectance, transmission and more. Find other videos on our website such as PIKE software tutorials and an assortment of product showcases.



Proper Filling of an IR Liquid Cell



IR Transmission Measurements of Diffuse Reflectance



Accessing Formulation in Polymeric Materials



ATR: Single vs. Multiple Reflection



Troubleshooting Inverted Bands in the Spectrum



Depth of Penetration vs. Effective Penetration



Monitoring the Thermal Treatment of a Heterogeneous Catalyst



KBr: Proper Use and Handling Methods



Factors Influencing Spectral Quality for Mid-IR Diffuse Reflectance



The ABC's of Liquid Transmission Sampling



Calculating Critical Angle



Sample Preparation for Mid-IR Diffuse Reflectance

DIFFUSE REFLECTION

Diffuse reflectance is a highly sensitive technique for the analysis of powdered and solid samples. Typically, a sample is ground with KBr into a fine powder and run without making pellets. Some samples can be run directly without dilution, especially if one is looking for minor components.

Diffuse reflectance sampling is ideally suited for automation and PIKE offers configurations for high-capacity sampling.

EasiDiff™ Page 42
Diffuse reflectance accessory
Analyze a wide variety of solid and powder samples

DiffusIR™ Page 43
Research-grade diffuse reflectance accessory
With environmental chambers for heating/cooling

UpIR™ Page 45
Upward-looking diffuse reflectance
Out-of-compartment design for large sample analysis

AutoDiff II™ Page 46
Automated diffuse reflectance
Analyze multiple samples with minimal intervention

XY Autosampler Page 47
Transmission and reflection in microplate format
Ideal for speed and reproducibility

Sample Prep Page 48
Sample collection, preparation and loading
For analysis of powders or solids

THEORY AND
APPLICATIONS
Page 49

EasiDiff – Workhorse Diffuse Reflectance Accessory



FEATURES

- Pre-aligned optical components for reproducible, high-quality data
- Micrometer-controlled sample positioning and focusing
- High-energy throughput providing nanogram sensitivity
- Precision slide for repeatable sample introduction and efficient collection of background and sample spectra
- Unique Sample Preparation and Loading Kit included

The PIKE Technologies EasiDiff is an economical, high-quality diffuse reflectance accessory designed to analyze a wide variety of solid samples. It is most often used in the analysis of pharmaceuticals, illicit drugs, inorganic solids and minerals, and powdered chemicals. The EasiDiff reduces the time required to produce an infrared spectrum compared to KBr pellet techniques. Typically, a small amount of sample (about 1%) is mixed with KBr powder and the spectrum is collected.

The EasiDiff employs an elegant, high-performance optical design for maximum energy throughput and ease of operation. Optical components critical to achieving this performance are permanently aligned. Focusing is achieved by bringing the sample (not the collection mirror) to the optimum position with a micrometer. A dual-position sample holder permits background and sample collection in a simple, two-step process.

A special version of the EasiDiff with gold-coated optics for NIR measurements is also available.

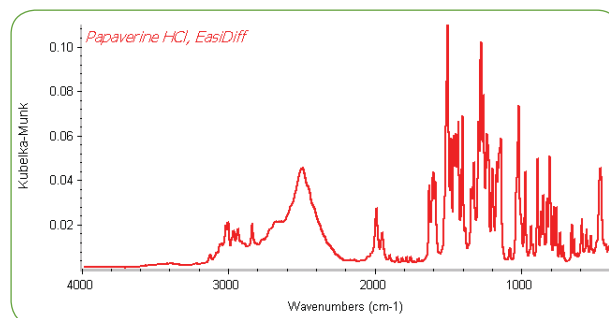

A spectrum of papaverine hydrochloride (1% in KBr powder) collected using the PIKE Technologies EasiDiff diffuse reflectance accessory.

ORDERING INFORMATION

PART NUMBER DESCRIPTION

042-10XX EasiDiff Accessory with Sample Preparation Kit
Includes 2 micro sample cups, 2 macro sample cups, EasiPrep Sample Preparation Kit, alignment mirror, 35-mm mortar with pestle and KBr powder (100 g)



042-50XX EasiDiff Accessory, NIR Version with Gold-Coated Optics
Includes 2 micro sample cups, 2 macro sample cups, EasiPrep Sample Preparation Kit, alignment mirror, 35-mm mortar with pestle and KBr powder (100 g)

Note: Replace XX with your spectrometer's Instrument Code. [Click for List >](#)

OPTION

PART NUMBER DESCRIPTION

042-3010 Abrasion Sampling Kit
Includes sample collector tool and stainless steel sample post, 25 diamond abrasive disks and 75 silicon carbide abrasive disks



Notes: The abrasion sampling kit is used to measure intractable solids. Disks are disposable. Ordering information for replacements may be found below.

REPLACEMENT PARTS AND SUPPLIES

PART NUMBER DESCRIPTION

042-2010	Micro Sample Cup, 6.0 mm diameter, 1.6 mm deep (2 ea.)
042-2020	Macro Sample Cup, 10 mm diameter, 2.3 mm deep (2 ea.)
042-2025	EasiDiff Sample Slide
160-8010	KBr Powder (100 g)
042-3020	Abrasion Disks, silicon carbide (100 ea.)
042-3025	Abrasion Disks, diamond (50 ea.)
042-3030	Sample Cup Holder and Base
042-3040	Sample Preparation Kit
042-3080	Alignment Mirror, aluminum
042-3082	Alignment Mirror, gold
042-3060	Flat Sample Post

Note: Please contact PIKE Technologies for items not described in this list.

DiffusIR – Research Grade Diffuse Reflectance Accessory



FEATURES

- Large, highly efficient collection optics for maximum sensitivity and detection limits
- Micrometer-controlled sample focus to optimize results for every sample
- Optional environmental chambers for heating, cooling, high-vacuum and high-pressure applications
- Quick release feature of environmental chambers for easy insertion and removal of sealed chambers
- Digital PC controller option for macro control of data collection at user specified temperatures or times
- Sealed and purgeable optical design to eliminate water vapor and carbon dioxide interference

The PIKE Technologies DiffusIR™ is a research-grade diffuse reflectance accessory with an efficient optical design accommodating the optional PIKE Technologies environmental chambers. These specialized chambers can be used to study thermodynamic properties of materials, to determine reaction mechanisms, to perform catalytic studies and much more.

The heart of the DiffusIR is a unique monolithic ellipsoidal reflector permanently fixed in place – eliminating the need for repositioning the focus optics for sample placement. The DiffusIR optical design is optimized to efficiently collect diffuse radiation generated from the sample and minimize the effects of the specular radiation component.

Optical geometry of the DiffusIR accessory

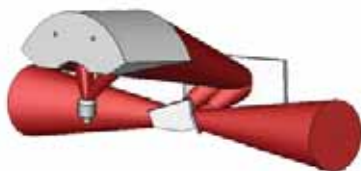

With the DiffusIR, sample introduction is performed using an integral 2-position slide – enabling background and sample spectra to be collected without loss of purge. The sample height can be optimized by using the micrometer sample focusing adjustment. In this manner the sensitivity of the accessory is maximized without sacrificing precision. The DiffusIR comes with a Sample Preparation and Loading Kit and a Sample Abrasion Kit for the analysis of intractable samples. The DiffusIR optics are enclosed and equipped with purge tubes for the elimination of atmospheric interferences.

Advanced temperature studies of materials in controlled environments can be done using the PIKE environmental chambers. Chambers for the DiffusIR can be operated at temperatures ranging from -150 to 1000 °C and at pressures up to 1500 psi. The optional chambers are easily inserted into the DiffusIR and secured using push-lock pins.



Coupling the environmental chambers with the PIKE PC-Controlled Temperature Module and TempPRO™ software provides the ability to graphically set up the experiment with up to 100 ramps and initiate data collection at specified time or temperature intervals when used with most FTIR instruments.

A special version of the DiffusIR with gold-coated optics is available for maximum mid-IR performance and for NIR diffuse reflectance sampling. The DiffusIR and its options are compatible with most FTIR spectrometers.

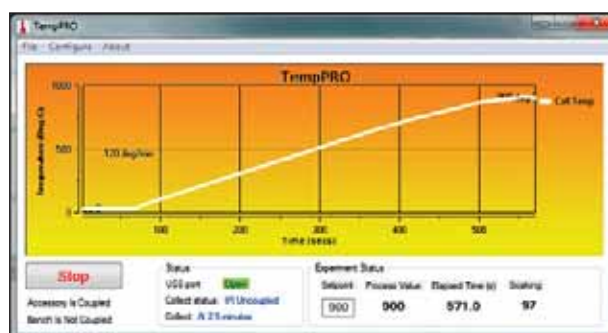

PIKE Technologies TempPRO software provides a graphical interface for temperature control and kinetic measurements.

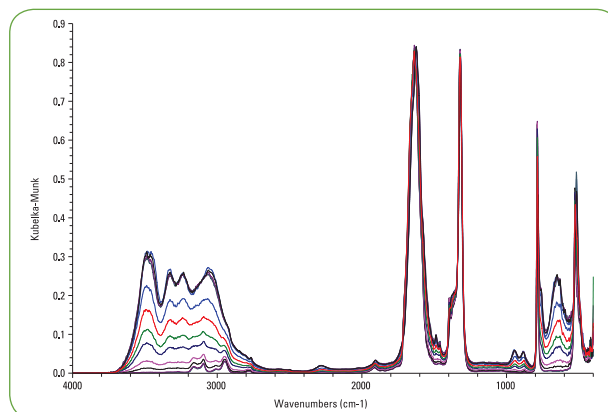

Thermal transformation of hydrated inorganic compound measured using the DiffusIR with environmental chamber. Spectra automatically collected between 80 and 160 °C at 5° increments using PIKE TempPRO software.



Heated environmental chamber shown with connections

ORDERING INFORMATION

DIFFUSIR ACCESSORY (must select one)

PART NUMBER	DESCRIPTION
041-10XX	DiffusIR Accessory <i>Includes Sample Preparation Kit with 2 micro and 2 macro sample cups, sample loading tools, Abrasion Sampling Kit, SiC and diamond sampling disks, alignment mirror, 35-mm mortar with pestle and KBr powder (100 g)</i>
041-60XX	DiffusIR Accessory with Gold-Coated Optics <i>Includes Sample Preparation Kit with 2 micro and 2 macro sample cups, sample loading tools, Abrasion Sampling Kit, SiC and diamond sampling disks, alignment mirror, 35-mm mortar with pestle and KBr powder (100 g)</i>

Note: Replace XX with your spectrometer's Instrument Code. [Click for List >](#)

DIFFUSIR OPTIONS

PART NUMBER	DESCRIPTION
162-4150	DiffusIR Environmental Chamber, HTV, ambient to 500 °C
162-4200	DiffusIR Environmental Chamber, HTV, ambient to 1000 °C
162-4180	High-Pressure Adapter Dome for Chambers, HTV
162-4140	DiffusIR Environmental Chamber, LTV, -150 to 500 °C

Notes: HTV and LTV chambers require the selection of a temperature control module. DiffusIR Chambers include front plate accommodating environmental chamber (easily changeable with standard DiffusIR front plate), Pin-Loc chamber insertion for easy sample exchange, KBr window, ceramic sampling cups compatible with vacuum and reaction formats, ports and 2 shut-off valves for vacuum operation and ports for connection of water cooling. The 500 °C and 1000 °C HTV chambers may be fitted with the high-pressure adapter and are easily switchable from standard vacuum to high-pressure operation. The LTV chamber is not compatible with simultaneous pressurization and low temperature operation. Operation of the LTV at sub-ambient temperatures requires part number 162-4165 Liquid Nitrogen-Cooled System and Temperature Control Module and rotary pump for vacuum insulation. All chambers require a liquid circulator to reduce heat transfer to the outer housing and to preserve the life of the chamber heaters.

TEMPERATURE CONTROL MODULES

PART NUMBER	DESCRIPTION
076-2450	PC Controlled Temperature Module, HTV Chambers <i>Includes Digital Temperature Selection and TempPRO software</i>
076-2250	Digital Temperature Control Module, HTV Chambers
162-4165	Liquid Nitrogen-Cooled System and Temperature Control Module DiffusIR Environmental Chamber, LTV, -150 to 500 °C

Notes: PC Controlled Temperature Module with TempPRO software provides a graphical user interface for setting experiment parameters and data collection. Please contact PIKE for PC compatibility. The Temperature Control Modules for the HTV and LTV chambers are not interchangeable.

REPLACEMENT PARTS AND SUPPLIES

PART NUMBER	DESCRIPTION
170-1100	Liquid Recirculator
042-2010	Sample Cup, micro, 6 mm diameter, 1.6 mm deep (2 ea.)
042-2020	Sample Cup, macro, 10 mm diameter, 2.3 mm deep (2 ea.)
042-3030	Sample Cup Holder and Base
160-8010	KBr Powder (100 g)
042-3040	Sample Preparation Kit
042-3010	Abrasion Sampling Kit
042-3020	Abrasion Disks, silicon carbide (100 ea.)
042-3025	Abrasion Disks, diamond (50 ea.)
042-3060	Flat Sample Post
042-3080	Alignment Mirror, aluminum
042-3082	Alignment Mirror, gold
162-4303	Rotary Pump for vacuum insulation

REPLACEMENT PARTS AND SUPPLIES (cont.)

PART NUMBER	DESCRIPTION
160-1132	Disk, KBr, 32 x 3 mm
160-1113	Disk, ZnSe, 32 x 3 mm
160-1231	Disk, ZnSe, 32 x 3 mm, with anti-reflective coating
160-5049	Disk, SiO ₂ , 32 x 3 mm
160-5125	Disk, SiO ₂ , 32 x 3 mm, low OH
160-1159	Disk, Si, 32 x 3 mm
162-4210	O-Ring for DiffusIR Chamber (10 ea.)
162-4215	O-Ring for DiffusIR Chamber cooling line (10 ea.)
162-4251	Ceramic Cup for DiffusIR Chamber, porous
162-4270	Alignment Mirror for DiffusIR Chamber

Notes: Please contact PIKE Technologies for items not described in this list.

DIFFUSIR SPECIFICATIONS

Optical Design	3X ellipsoidal
Angle of Incidence	30 degrees, nominal
Dimensions (W x D x H)	180 x 230 x 130 mm (excluding purge tubes and baseplate)
Sample Focus	Micrometer
Sample Positions	2 positions, slide stops for background and sample with no purge loss
Sample Cups	Micro: 6 x 1.6 mm deep Macro: 10 x 2.3 mm deep
Purge	Standard purge tubes and purge connection

ENVIRONMENTAL CHAMBER SPECIFICATIONS

Temperature Range, HTV	Ambient to 500 or 1000 °C
Temperature Range, LTV	-150 to 500 °C
Accuracy	+/- 0.5% of set point
Input Voltage	100–240 VAC (HTV version) 110/220 V switchable (LTV version)
Operating Voltage	28 VDC/84 W (HTV and LTV versions)
Temperature Control	Digital or Digital PC
Heating Rate, Maximum	120 °C/minute, HVT
Kinetic Setup (requires Digital PC Controller, includes PIKE TempPRO software)	<ul style="list-style-type: none"> Up to 100 temperature ramps Individual ramp rate and hold time settings Graphical display of experiment settings Trigger data collection at specified times or temperatures USB interface
Sensor	K Type (for HTV) RTD Type, Pt100 (for LTV)
Vacuum Achievable	1 x 10 ⁻⁶ Torr (13 x 10 ⁻⁴ Pa)
Window Size	32 x 3 mm disk (vacuum) 32 mm ZnSe dome (pressure)
Leak Rate	< 6.0 x 10 ⁻¹¹ Pa m ³ /sec
Pressure Maximum	<ul style="list-style-type: none"> 1500 psi, with High-Pressure Adapter (available in HTV versions only) 14.7 psi (1 atmosphere) using KBr window
Sample Cup Size	Macro: 6.0 mm OD, 4.0 mm height Micro: 4.7 mm ID, 2.0 mm depth
Sample Cup Design	Porous ceramic compatible with powders and gas flow
Cooling Ports	Quick-Fit, 6 mm ID
Gas/Vacuum Ports	1/8" Swagelok®

UpIR – Upward Looking Diffuse Reflectance Accessory



FEATURES

- Upward-looking optics provide fast and easy analysis of samples placed face down on the sample port
- Out-of-compartment design for analysis of large samples
- High optical throughput and exceptional signal-to-noise ratio
- Analysis of powders, ground solid samples and coatings on metallic surfaces
- Pre-aligned, fixed-position optical components for reproducible, high-quality data
- Micrometer-controlled sample stage positioning and focusing
- Optional gold-coated optics version for highest performance mid-IR and NIR applications

The UpIR is an innovative FTIR accessory developed to support a wide range of diffuse reflectance applications. To make measurements, simply place large, solid samples face down onto the top plate of the accessory. Powders can be placed into a suitable sampling cup at the top of the UpIR. A mask set is included for the analysis of small solids such as gems and precious stones.

This design is uniquely suitable for mid-IR analysis of coatings on metallic surfaces of large or small samples. For this application, analysis is rapid and easy because no sample preparation or cleanup is required. Since the sampling area of the UpIR is above the plane of the FTIR instrument, even large samples that do not fit into the sample compartment can be analyzed with this accessory.

The accessory is equipped with an upward-looking, high-performance ellipsoidal mirror. The sampling stage provides a sampling port with inserts for diffuse reflectance or specular reflectance measurements.

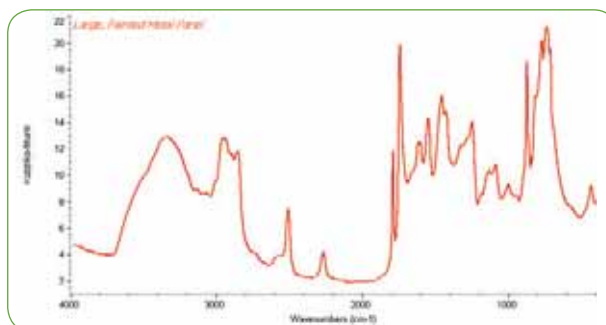
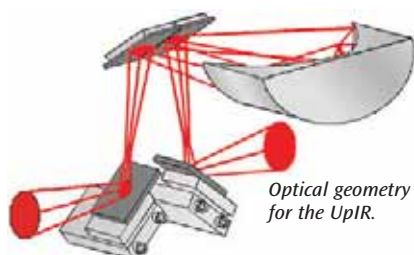

Analysis of a large painted metal panel using the UpIR accessory.

All mirrors, including the ellipsoidal collection mirror, are permanently mounted. The position of the sampling stage is controlled with an adjustable micrometer to achieve the best possible throughput. Spectral analysis involves collecting a background spectrum with the reference mirror in the sampling position. After this step, the sample is simply placed face down onto the sampling port and data collection is initiated.

The gold-coated optics version of the UpIR provides the highest throughput in the mid-IR spectral region and is recommended for NIR sampling. The UpIR accessory includes a solids sampling plate for flat samples, a ZnSe-windowed sampling cup for powders or small solids analysis and a 4-piece mask set (aperture diameters of 10, 7, 5 and 3 mm). The accessory is equipped with purge tubes for elimination of CO₂ and water interferences from infrared spectra.

For NIR sampling of solids, powders or tablets, the sapphire-windowed sampling cup is recommended. In the NIR spectral region samples can be analyzed while contained in a glass vial; the optional 21-mm glass vial holder is recommended.

ORDERING INFORMATION

PART NUMBER	DESCRIPTION
044-10XX	UpIR – Out-of-Compartment Diffuse Reflectance Accessory <i>Includes solids sampling insert and powders sampling insert with ZnSe window, mask set, gold mirror, purge tubes, purge kit and spectrometer baseplate</i>
044-60XX	UpIR – Out-of-Compartment Diffuse Reflectance Accessory with Gold-Coated Optics <i>Includes solids sampling insert and powders sampling insert with ZnSe window, mask set, gold mirror, purge tubes, purge kit and spectrometer baseplate</i>

Note: Replace XX with your spectrometer's Instrument Code. [Click for List >](#)

UPIR OPTIONS

PART NUMBER	DESCRIPTION
044-3030	Solids Sampling Insert
044-3040	Powders Sampling Insert (order window separately)
044-3010	Glass Vial Holder, 21 mm
044-3020	Sample Vials with Threaded Caps, 21 mm x 70 mm (200 ea.)
044-3050	UpIR Mask Set, 3, 5, 7 and 10 mm
160-1155	Window, ZnSe, 25 x 2 mm
160-1307	Window, Ge, 25 x 2 mm
160-1201	Window, AMTIR, 25 x 2 mm
160-5000	Window, Sapphire, 25 x 2 mm
048-3000	Diffuse Gold Reference

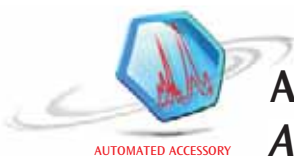

AutoDiff II – Automated Diffuse Reflectance Sampling



FEATURES

- Complete automated diffuse reflectance accessory and software package for unattended analysis of up to 60 samples
- High-performance optical design collects maximum amount of diffusely reflected energy and provides high-quality spectra in a short time period
- Flexible sample sequencing and background collection to provide maximum sampling efficiency and greatly minimize atmospheric contributions to sample spectra
- Easily programmable AutoPRO software delivers automated sample collection
- Easily removable sample tray to speed sample loading and unloading

The AutoDiff II is a high-performance, automated diffuse reflectance accessory developed to analyze multiple samples with minimal user intervention. Typical applications include powdered pharmaceutical samples, high-throughput forensic sampling, kidney stone analysis, soils analysis and analysis of many other powdered samples where speed and efficiency are important. The design employs an automated R-theta sampling stage providing diffuse reflectance analysis with greatly reduced operator intervention and increased sample throughput.

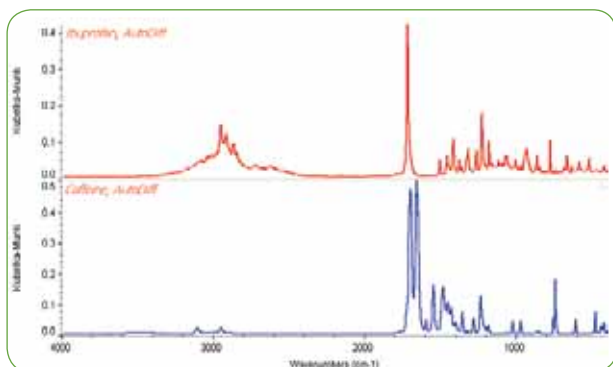

Spectra of pharmaceuticals using the AutoDiff II accessory.

The optical design of the AutoDiff II utilizes a high-efficiency fixed ellipsoidal reflector to collect the maximum amount of diffusely reflected energy from the sample. Other optical components important to achieving this high performance are aligned and permanently located. The accessory is baseplate-mounted in the FTIR spectrometer sample compartment and can be purged independently or it can use the spectrometer's purge.

Spectral quality and reproducibility are excellent with the AutoDiff II. By programming the collection of spectra at precise time periods and alternating sample and background collection, any effects of atmosphere are greatly reduced.

The PIKE AutoDiff II fully automates diffuse reflectance FTIR spectroscopy. The sample holder contains positions for 60 samples, plus a center position for a background sample, which usually consists of pure KBr powder.

The sample plate is marked into six areas, labeled from A to F. Each area has ten sample positions marked from 1 through 10. This sample position numbering scheme is also used within the software for describing and positioning the samples.

The AutoDiff II is controlled by PIKE AutoPRO software which incorporates multi-operator sample submission. The system is extremely flexible and the graphical user interface is intuitive and simple. Multiple operators may independently log samples onto the system. The AutoPRO software integrates easily with most commercially-available FTIR software packages.

The AutoDiff II is also available with gold-coated optics for highest performance mid-IR analysis and for automated NIR diffuse reflectance sampling.



ORDERING INFORMATION

PART NUMBER	DESCRIPTION
043-29XX	AutoDiff II – Automated Diffuse Reflectance System Includes motion control unit (100-240 VAC), AutoPRO software 60-position sample mounting tray, 60 macro sample cups and Sample Preparation Kit
043-79XX	AutoDiff II – Automated Diffuse Reflectance System with Gold-Coated Optics Includes motion control unit (100-240 VAC), AutoPRO soft- ware, 60-position sample mounting tray, 60 macro sample cups and Sample Preparation Kit

Note: Replace **XX** with your spectrometer's Instrument Code. [Click for List >](#)

REPLACEMENT PARTS AND OPTIONS

PART NUMBER	DESCRIPTION
043-3090	AutoDiff II Sampling Cups, macro (60 ea.)
043-3085	AutoDiff II Sampling Cups, micro (60 ea.)
043-0902	AutoDiff II 60-Position Sampling Tray
042-2010	Sample Cup, micro, 6.0 mm diameter, 1.6 mm deep (2 ea.)
042-2020	Sample Cup, macro, 10 mm diameter, 2.3 mm deep (2 ea.)
042-3010	Abrasion Sampling Kit
042-3020	Abrasion Disks, silicon carbide (100 ea.)
042-3025	Abrasion Disks, diamond (50 ea.)
042-3080	Alignment Mirror, aluminum
042-3082	Alignment Mirror, gold

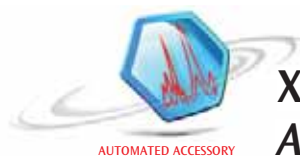

XY Autosampler – Transmission and Reflection, Automated Sampling in Microplate Format



FEATURES

- Complete hardware and software package for automated analysis with standard 24-, 48-, or 96-well plates. Special configurations available.
- Diffuse reflectance of powdered samples or specular reflectance sampling for reaction residues
- Gold-coated optics version for highest performance mid-IR and NIR sampling
- Optional transmission sampling with integrated DTGS or InGaAs detector and transmission sampling plate
- Fully enclosed, purgeable design with front-loading tray
- In-compartment mounting, compatible with most FTIR spectrometers

The PIKE Technologies XY Autosampler is designed around standard 24-, 48- or 96-well microplate architectures – ideal for high-efficiency sample loading and FTIR analysis. The loading tray moves to a position outside of the accessory for easy loading and unloading of samples while conserving the purge. This also permits interface to a robot/autoloader.

Applications include high throughput analysis of liquid residues and chemical reactions, powdered samples, and automated diffuse reflection analysis. The XY Autosampler is available with standard aluminum optics or with gold-coated optical components for highest performance in mid-IR and optimized NIR sampling.

The XY Autosampler features an X, Y stage with both axes driven by high-precision servo motors with optical encoders for speed and reproducibility. USB and DC power are the only external connections required for this accessory. The transmission option requires a spectrometer external IR detector port.

Programming and control of the XY Autosampler is done through PIKE Technologies' AutoPRO software, which can be integrated easily with most FTIR software packages.

The optical design of the XY Autosampler is based upon a precision ellipsoidal reflector. The size of the spot illuminated at the sample is approximately 2 mm which is ideal for up to 96-well configurations. The accessory is compatible with most FTIR spectrometers.

A special silicon well plate is available for mid-IR sample analysis by transmission. This unique 96-well plate allows collection of transmission spectra in mid-IR range. For diffuse reflection measurements a dedicated plate is available. The plate features 96 polished cavities for placement of powder samples. A 24-well plate for disposable cups is available for diffuse measurements. Please contact PIKE Technologies if you require specialized sampling plate configurations.

High-quality FTIR spectra of solvent residues collected with the XY Autosampler.

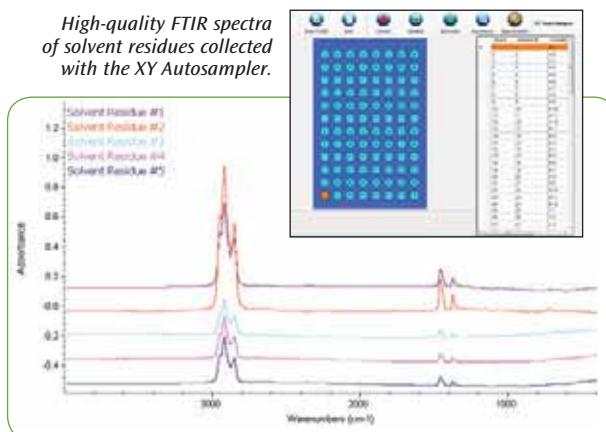

SPECIFICATIONS

Optics	Elliptical – 3X beam demagnification
Accuracy	+/- 25 μ m
Mechanical Specifications	
Repeatability	+/- 5 μ m
Resolution	1 μ m
Minimum Run Time	56 seconds for 96-well plate (actual time is spectrometer and application dependent)
Computer Interface	USB
Dimensions (W x D x H)	6.25 x 13.2 x 5.55" (including micrometer)
Weight	10 lbs

ORDERING INFORMATION

PART NUMBER	DESCRIPTION
047-21XX	XY Autosampler – Diffuse Reflectance
047-61XX	XY Autosampler – Diffuse Reflectance with Gold-Coated Optics
047-22XX	XY Autosampler – Diffuse Reflectance/Transmission with integrated DTGS detector
047-62XX	XY Autosampler – Diffuse Reflectance/Transmission with Gold-Coated Optics with integrated DTGS detector
047-23XX	XY Autosampler – Diffuse Reflectance/Transmission with integrated InGaAs detector
047-63XX	XY Autosampler – Diffuse Reflectance/Transmission with Gold-Coated Optics with integrated InGaAs detector

Notes: Replace **XX** with your spectrometer's Instrument Code. [Click for List >](#)
All XY Autosamplers include PIKE AutoPRO software and a 96-well sampling plate. Diffuse Reflectance/Transmission versions include a 96-well plate for diffuse reflectance and a 96-well plate for transmission. For other options please contact PIKE Technologies. For transmission option, your spectrometer must be capable of interfacing with an external detector. A glass-bottom well plate is recommended for NIR transmission measurements.

OPTIONS

PART NUMBER	DESCRIPTION
073-9110	96-Well Diffuse Reflectance Sampling Plate
073-9130	96-Well Si Transmission Sampling Plate
073-9160	24-Well Diffuse Reflectance Sampling Plate for Disposable Cups
162-1920	Disposable Cups (50 ea.)

Sample Preparation and Loading Kit – The Easiest Way to Work With Powder Samples



The Sample Preparation and Loading Kit makes the handling of powder samples for diffuse reflection sampling easy. It includes a round mounting base and a matching tray with an opening which accommodates sampling cups. The cup is placed in the assembly and overfilled with sample, and then excess powder is leveled-off with a spatula. The overflow is retained on the tray and can be easily returned to the sample container or disposed.

Two standard sampling cups offer 0.18 and 0.03 cubic centimeter capacities (10-mm diameter, 2.3-mm deep and 6.0-mm diameter, 1.6-mm deep). The required approximate weight of the sample/KBr mixture is 450 mg for the large cup and 80 mg for the small one.

ORDERING INFORMATION

PART NUMBER	DESCRIPTION
042-3040	Sample Preparation and Loading Kit <i>Includes 2 micro and 2 macro cups, alignment mirror, sampling cup holder and base, 2 spatulas, brush</i>
042-2010	Sample Cup, micro, 6-mm diameter, 1.6-mm deep (2 ea.)
042-2020	Sample Cup, macro, 10-mm diameter, 2.3-mm deep (2 ea.)
042-3030	Delrin® Sampling Cup Holder and Base
042-3080	Alignment Mirror, aluminum
042-3082	Alignment Mirror, gold
042-3070	Camel Hair Brush
042-3035	Spatula, spoon
042-3050	Spatula, flat
160-8010	KBr Powder (100 g)

Note: The Sample Preparation and Loading Kit is included with EasiDiff, DiffusIR and AutoDiff diffuse reflection accessories.

Abrasion Sampling Kit – The Plastic Bumper Sampler



The Abrasion Sampling Kit consists of a sample collector tool and a set of silicone carbide and diamond disks. Sampling is performed by abrading the surface of the investigated substance with a selected disk. The disk is placed in the accessory and a diffuse reflection spectrum of the material is collected. This method is particularly useful for the analysis of large painted surfaces (e.g. car panels) and other awkward objects.

- Convenient set of tools for collection of difficult solid samples
- Rigid construction, diamond and silicon carbide disks

ORDERING INFORMATION

PART NUMBER	DESCRIPTION
042-3010	Abrasion Sampling Kit <i>Includes sample collector tool with stainless steel flat sample post, 75 SiC disks and 25 diamond abrasion disks</i>
042-3020	Abrasion Disks, silicon carbide (100 ea.)
042-3025	Abrasion Disks, diamond (50 ea.)
042-3060	Flat Sample Post

Diffuse Reflection – Theory and Applications

Diffuse Reflectance – Ideal for Powdered Samples and Intractable Solids

Diffuse reflectance is an excellent sampling tool for powdered or crystalline materials in the mid-IR and NIR spectral ranges. It can also be used for analysis of intractable solid samples. As with transmission analysis, samples to be run by diffuse reflectance are generally ground and mixed with an IR transparent salt such as potassium bromide (KBr) prior to sampling. Diffuse reflectance is an excellent sampling technique as it eliminates the time-consuming process of pressing pellets for transmission measurements. Diffuse reflectance can also be used to study the effects of temperature and catalysis by configuring the accessory with a heating or cooling environmental chamber.

Perhaps one of the greatest additional benefits of diffuse reflectance sampling is that it is ideally amenable to automation. Methods can be developed with a manual version diffuse reflection accessory and then moved to automation to increase sample throughput. PIKE Technologies offers several diffuse reflectance accessory configurations – basic, advanced with heat chamber capabilities, upward directed IR beam for easy sampling access and fully automated for maximum sampling efficiency.

How Diffuse Reflectance Works

Diffuse reflectance relies upon the focused projection of the spectrometer beam into the sample where it is reflected, scattered and transmitted through the sample material (shown below). The back reflected, diffusely scattered light (some of which is absorbed by the sample) is then collected by the accessory and directed to the detector optics.

Only the part of the beam that is scattered within a sample and returned to the surface is considered to be diffuse reflection.

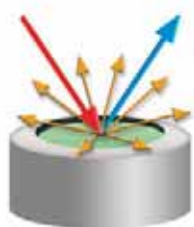

- ◆ Incident Radiation
- ◆ Diffuse Reflection
- ◆ Specular Reflection

Some powders may be analyzed by diffuse reflectance as neat samples (coal samples, soil samples, diffuse coatings on a reflective base). Usually, the sample must be ground and mixed with a non-absorbing matrix such as KBr. The sample to matrix ratio is generally between 1 to 5% (by weight). Diluting ensures a deeper penetration of the incident beam into the sample which increases the contribution of the scattered component in the spectrum and minimizes the specular reflection component.

The specular reflectance component in diffuse reflectance spectra causes changes in band shapes, their relative intensity, and, in some cases, it is responsible for complete band inversions (Reststrahlen bands). Dilution of the sample with a non-absorbing matrix minimizes these effects (particle size and sample loading mechanics also play an important role).

This is shown below in the spectral data for caffeine, where the upper spectrum is diluted to about 2% by weight in KBr and demonstrates very high quality with sharp, well-defined absorbance bands. The lower spectrum is of undiluted caffeine measured by diffuse reflectance and shows derivative-shaped bands in the 1700 cm^{-1} and 1500 cm^{-1} region of the data. The upper spectrum of diluted caffeine is clearly of higher spectral quality than that of the undiluted caffeine.

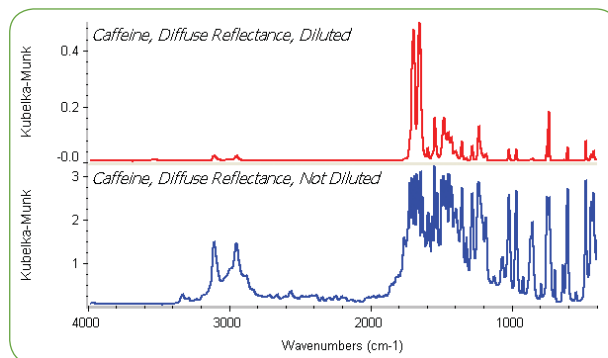

Diffuse reflectance spectra showing greatly improved results from sample dilution.

Other factors related to high spectral quality for diffuse reflectance sampling are listed below.

- **Particle Size** – reducing the size of the sample particles reduces the contribution of reflection from the surface. Smaller particles improve the quality of spectra (narrow bandwidths and better relative intensity). The recommended size of the sample/matrix particles is 50 microns or less (comparable to the consistency of the finely ground flour). This fine powder is easily achieved by using the PIKE Technologies ShakIR ball mill.
- **Refractive Index** – effects result in specular reflectance contributions (spectra of highly reflecting samples will be more distorted by the specular reflectance component). This effect can be significantly reduced by sample dilution.
- **Homogeneity** – samples prepared for diffuse reflectance measurements should be uniformly and well mixed. Non-homogenous samples will lack reproducibility and will be difficult to quantify. An ideal way to mix samples for diffuse reflectance is by using the PIKE Technologies ShakIR.
- **Packing** – the required sample depth is governed by the amount of sample scattering. The minimum necessary depth is about 1.5 mm. The sample should be loosely but evenly packed in the cup to maximize IR beam penetration and minimize spectral distortions.

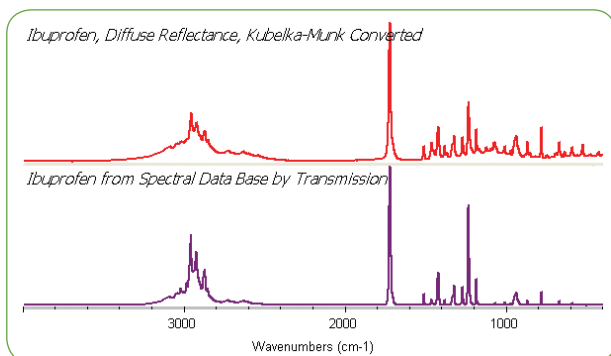

Diffuse reflectance spectra of ibuprofen with Kubelka-Munk conversion compared to a transmission spectrum.

Even with all these sample preparation practices, the raw diffuse reflectance spectra will appear different from its transmission equivalent (stronger than expected absorption from weak IR bands). A Kubelka-Munk conversion can be applied to a diffuse reflectance spectrum to compensate for these differences. This conversion is available in most FTIR software packages.

The Kubelka-Munk equation is expressed as

$$f(R) = \frac{(1 - R)^2}{2R} = \frac{k}{s}$$

where R is the absolute reflectance of the sampled layer, k is the molar absorption coefficient and s is the scattering coefficient.

The spectra shown above demonstrate this spectral conversion for ibuprofen collected by diffuse reflectance. The sample was diluted to about 1% by weight in KBr and mixed using the ShakIR. The Kubelka-Munk converted spectrum for ibuprofen shows excellent comparison with the transmission spectrum and is easily identified using library search of a transmission spectral database.

The Kubelka-Munk equation creates a linear relationship for spectral intensity relative to sample concentration (it assumes infinite sample dilution in a non-absorbing matrix, a constant scattering coefficient and an “infinitely thick” sample layer). These conditions can be achieved for highly diluted, small particle samples (the scattering coefficient is a function of sample size and packing) and a sample layer of at least 1.5 mm. With proper sample preparation, diffuse reflectance spectroscopy can provide ppm sensitivity and high-quality results.

Plastic Bumpers and Tough Samples

Sometimes it is necessary to analyze a sample which simply does not fit in a spectrometer’s sample compartment – the analysis of polymer-based automotive components or painted panels are typical examples.

A special diffuse reflectance technique allows quick and simple analysis of such samples in a relatively non-destructive manner. A small amount of the sample can be collected by abrasion on a diamond or silicon carbide abrasion disk and analyzed immediately with the help of a diffuse reflectance accessory.



Heavy-duty sample collecting tool with diamond abrasion disk on removable sample post



The figure below shows the diffuse reflectance spectrum of an automotive body component. The PIKE Abrasion Sampling Kit with diamond sampling disk was rubbed across the large automotive component which collects some of the polymer material into the web of the sampling disk. Spectra were co-added for 1 minute and ratioed to the diamond disk background spectrum. The resulting spectrum is of excellent quality and is identified as a polypropylene copolymer.

Diffuse reflectance can also be used for the analysis of liquid samples. In this application a small amount of the sample is dispensed directly onto the KBr powder and analyzed.

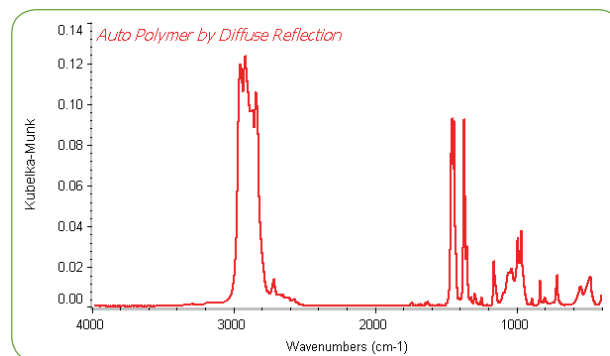

Diffuse reflectance spectrum using diamond abrasion disk.

For the analysis of powders the following procedure is recommended:

- Place about 200–400 mg of KBr into the ShakIR ball mill vial with a stainless steel ball and grind for 30 seconds
- Fill the background diffuse cup with this KBr
- Remove excess KBr with a flat edge – the KBr should be loosely packed
- Add 1 to 5 mg of the sample to the remaining KBr in the ShakIR vial and mix for 30 seconds
- Fill the sample diffuse cup with this mixed sample/KBr
- Remove excess sample with a flat edge – the sample should be loosely packed
- Place the background and sample diffuse cups into the sample holder
- Slide the sample holder into the accessory
- Position the KBr cup in the beam and collect a background
- Move the holder to the sample position and collect a sample spectrum (the ratio of these two spectra will produce a spectrum of the sample)
- Convert the raw diffuse reflectance spectrum to Kubelka-Munk

Under ideal conditions the transmission of the strongest band in the spectrum should be in the 50% range. If the resulting bands are too intense or distorted, further dilute the sample and make sure that all other measurement affecting factors (particle size, homogeneity and packing) are within required limits.

Summary

Diffuse reflectance accessories make the analysis of a wide range of solid samples easier, faster and more efficient. Advanced options for diffuse reflectance provide the ability to heat and cool the sample and monitor a reaction process. Automation versions of diffuse reflectance accessories provide the ability to greatly increase sample throughput.

SPECULAR REFLECTION

Specular reflectance sampling represents a very important technique useful for the measurement of thin films on reflective substrates, the analysis of bulk materials and the measurement of mono-molecular layers on a substrate material. Often this technique provides a means of sample analysis with no sample preparation – keeping the sample intact for subsequent measurements.



VeeMAX III™ Page 52
Variable Angle Specular Reflectance Accessory
Measurement of thin films and monolayers

10Spec™ Page 54
Fixed 10 Degree Angle of Incidence
Near-normal sample reflectivity measurement

30Spec/45Spec™ Page 55
Fixed 30 or 45 Degree Angle of Incidence
Thick films analysis

80Spec™ Page 56
Fixed 80 Degree Angle of Incidence
Measurement of thin films and mono-molecular layers

AGA™ Page 57
Advanced Grazing Angle Accessory
Thin films requiring precise spot size control

Absolute Reflectance Accessory Page 58
Measurement of optical surfaces, windows and metallic surfaces

THEORY AND
APPLICATIONS
Page 59



VeeMAX III – The Ultimate Variable Angle Specular Reflectance Accessory



FEATURES

- Selectable angle of incidence – from 30 to 80 degrees in 1 degree increments
- Measurement of thin films and monolayers to relatively thick films
- Optimize specular reflectance results with selectable angle of incidence
- Integrated position for IR polarization – essential for monolayer analysis and study of polymer orientation
- Optional single reflection ATR crystals – see ATR section
- Automated option with AutoPRO software for automated, high-precision experiments
- Sealed and purgeable optical design to eliminate water vapor and carbon dioxide interferences

The PIKE Technologies VeeMAX III is a high-performance research-grade specular reflectance accessory. Its unique variable angle optical design (U.S. Patent No. 5,106,196) makes it a key accessory to analyze a wide range of samples. Typical VeeMAX III applications include depth profiling, analysis of monolayers and ultra-thin films, determination of polymer orientation and spectroelectrochemistry. From monolayers to relatively thick films, all experiments may be

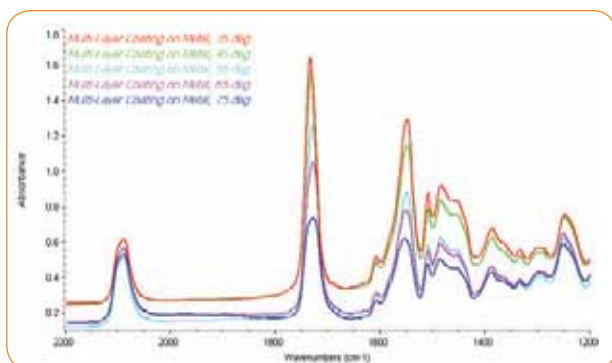

Optimization of the analysis of a multi-layered coating on metal substrate using the VeeMAX III.

optimized by varying the angle of incidence from 30 to 80 degrees. Changing the angle is as easy as turning the angle selector on the front panel of the accessory.

To make measurements, the sample is placed face down on the sampling surface. Designed for unrestricted access to the sampling area, large samples may be readily analyzed. Thanks to the optical design of this accessory and the quality of the optics, excellent throughput is realized even at high angles of incidence. All powered mirrors are diamond turned for optimal performance.

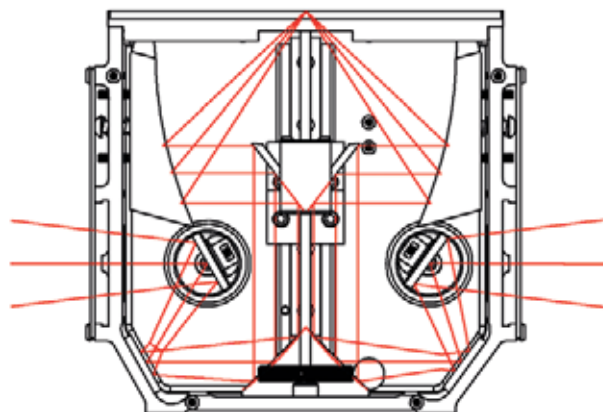

Proprietary beam path within the VeeMAX III specular reflectance accessory.

To suit different sample geometries, masks with 2", 5/8" and 3/8" apertures are provided. Another important design feature of the VeeMAX III is its enclosed optics for purging, which eliminates the need to purge the entire sample compartment. This significantly decreases sampling time. It is furnished with two polarizer mounts allowing the PIKE polarizer to be inserted into the accessory on either the source or detector side of the spectrometer. The polarizer setting dial is easily accessed while never breaking the purge when changing polarizer orientation.

To further expand on the versatility of the VeeMAX III, the accessory may be fitted with an ATR flat plate allowing for variable angle ATR experiments. Please see the ATR section of our catalog for complete configuration options.

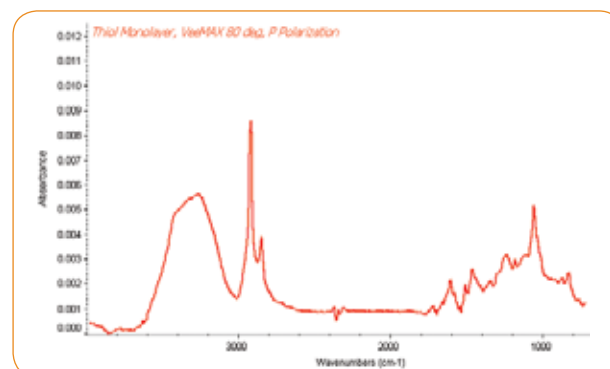

FTIR spectrum of thiol monolayer measured using the VeeMAX III specular reflectance accessory set at 80 degrees angle of incidence, ZnSe polarizer and MCT detector.

An optional automated version of the VeeMAX III accessory is available. It features a servo motor with USB interface and PIKE Technologies AutoPRO software. Operation of the VeeMAX III can be integrated with the spectrometer software of most FTIR instruments, which allows the operator to precisely and reliably control a wide range of angles of incidence and data collection simultaneously from a computer keyboard. Automated sampling decreases operator error and increases workflow productivity. Other advantages of an Automated VeeMAX III accessory include

- Computer-controlled precision, accuracy and repeatability
- Synchronization of mirror position changes with collection of sample spectra
- Tailor-made, predefined experiments
- “Hands-free” operation



AutoPRO Software configured for the VeeMAX III with automated polarizer.

A spectroelectrochemical cell option for the VeeMAX III is also available. The cell allows for specular experiments using a flat IR window or CaF₂ prism, where the beam reflects off the working electrode or for ATR experiments where often the ATR crystal serves as the working electrode. Windows and ATR crystals are removable. The electrochemistry cell is equipped with a precision micrometer for electrode positioning.



Electrochemical Cell assembly for VeeMAX III.

SPECIFICATIONS	
Optics	All reflective
Angle of Incidence Range	30 to 80 degrees
Sample Masks	2", 5/8" and 3/8"
Purge Sealing	Purge tubes and purge barb included
Dimensions (W x D x H)	177 x 92 x 162 mm (excludes baseplate)
FTIR Compatibility	Most, specify model and type
Spectroelectrochemical Vessel Dimensions	25 mm dia tapering to 19 mm, 25 mm tall
Spectroelectrochemical Vessel Volume	7.5 mL
Spectroelectrochemical Vessel Material	PTFE or PEEK

ORDERING INFORMATION	
PART NUMBER	DESCRIPTION
013-11XX	VeeMAX III <i>Includes sample masks (2", 5/8" and 3/8"), gold substrate alignment mirror, FTIR base mount, and purge tubes</i>
013-12XX	Automated VeeMAX III <i>Includes controller, cabling, sample masks (2", 5/8" and 3/8"), gold substrate alignment mirror, FTIR base mount, and purge tubes</i>

Note: Replace **XX** with your spectrometer's Instrument Code. [Click for List >](#)

VEEMAX III SAMPLING OPTIONS

PART NUMBER	DESCRIPTION
090-1000	Manual Polarizer, ZnSe
090-1200	Manual Polarizer, KRS-5
090-3000	Precision Manual Polarizer, ZnSe
090-3200	Precision Manual Polarizer, KRS-5
090-5000	Precision Automated USB Polarizer, ZnSe
090-5100	Precision Automated USB Polarizer, KRS-5

Note: Automated version includes PIKE Technologies AutoPRO software and controller. More polarizer options are found in the polarizer section of this catalog.

VEEMAX III REPLACEMENT PARTS

PART NUMBER	DESCRIPTION
013-4010	Specular Mask Set
300-0002	Gold Substrate Alignment Mirror, 1.25 x 3.0"

Note: Please contact PIKE Technologies for items not described in this list.

SPECTROELECTROCHEMICAL CONFIGURATIONS

PART NUMBER	DESCRIPTION
013-3300	Electrochemical Cell – PTFE
013-3370	Electrochemical Cell – PEEK
160-5527	Prism, CaF ₂ , 60 degree
013-3360	Crystal Holder, 60 degree
160-1144	Flat Window, CaF ₂ , 20 x 2 mm
160-1304	Flat Window, ZnSe, 20 x 2 mm
013-3320	Flat Window Holder

Notes: The electrochemical configuration requires Electrochemical Cell and VeeMAX III specular reflectance accessory. Must select one or more windows. Choose appropriate window holder. More window types for specular reflectance measurements may be found in our listing of transmission windows, 20 mm x 2 mm. Electrodes supplied by the end-user. See VeeMAX III with ATR product sheet for full ATR crystal and configuration options.

10Spec – Near-normal Sample Reflectivity Measurements



Standard 10Spec (above)
and Extended Height
10Spec (left)

FEATURES

- Measure sample reflectance
- Fixed 10 degree angle of incidence
- Sample illumination using collimated beam precisely fixed at 10 degrees
- Sampling mask sizes of 2", 5/8" and 3/8"
- Purge cover and purge tubes for removal of atmospheric interferences
- Extended Height 10Spec to accommodate large samples

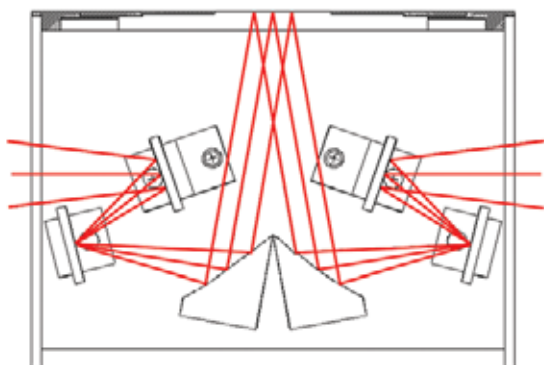

Beam path within the 10Spec specular reflectance accessory.

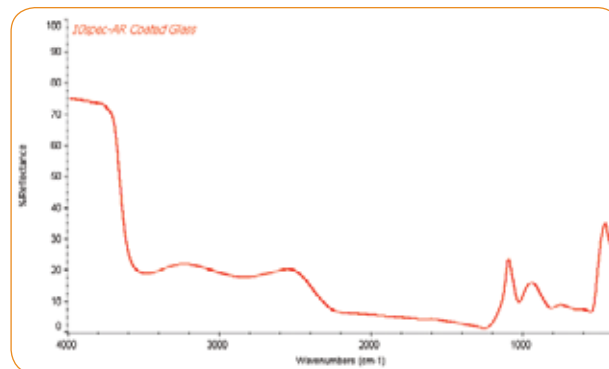

FTIR spectrum measuring the reflectivity of glass with the 10Spec.

The PIKE Technologies 10Spec is an optimized specular reflectance accessory designed to make high-performance measurements of sample reflectivity. It produces a collimated beam to illuminate the sample area such that the reflectivity measurement is made at a uniform 10 degree angle of incidence and not an average of angles produced by a focused beam accessory design. At a near-normal angle, the polarization effects on reflectivity are minimized. The optics are enclosed to allow for purging.

The 10Spec is recommended to measure the reflectivity of glass. It may also be used to measure near-normal reflectivity of a wide variety of surfaces including military devices, reflecting optics, anti-reflective (AR) coated surfaces, and other reflecting and non-reflecting materials.

The 10Spec is available in two versions. The standard version is 118-mm tall whereas the Extended Height 10Spec is 205-mm tall, which positions the sample above the top of the FTIR instrument. The Extended Height 10Spec is designed to accommodate samples that are too large to fit within the confinements of the sample compartment.

SPECIFICATIONS

Optics	All reflective
Angle of Incidence	10 degrees
Sample Masks	2", 5/8" and 3/8"
Purge Sealing	Purge tubes and purge barb included
Dimensions (W x D x H)	
Standard	159 x 90 x 118 mm (excludes baseplate)
Extended Height	159 x 90 x 205 mm (excludes baseplate)
FTIR Compatibility	Most, specify model and type

ORDERING INFORMATION

PART NUMBER	DESCRIPTION
010-10XX	10Spec – 10 Degree Specular Reflectance Accessory Includes 3 sample masks (2", 5/8" and 3/8"), gold substrate alignment mirror and FTIR base mount
010-11XX	Extended Height 10Spec Accessory Includes 3 sample masks (2", 5/8" and 3/8"), gold substrate alignment mirror and FTIR base mount

Note: Replace XX with your spectrometer's Instrument Code. [Click for List >](#)

10SPEC REPLACEMENT PARTS AND SAMPLING OPTIONS

PART NUMBER	DESCRIPTION
010-3010	Specular Mask Set
300-0002	Gold Substrate Alignment Mirror (1.25" x 3.0")

30Spec and 45Spec – Specular Reflectance for Thick Films



FEATURES

- Measurement of thick films
- Measurement of film thickness by specular reflectance
- Fixed 30 degree angle of incidence
- Special version – 45Spec for 45 degree angle of incidence
- Sample masks to define sampling area
- Slide-mount design for easy installation of accessory – fits all FTIR spectrometers

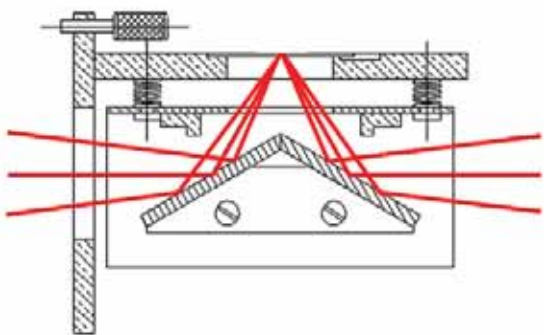

Optical geometry for the 30Spec.

The PIKE Technologies 30Spec is ideal for the measurement of relatively thick films by specular reflectance. Samples are simply laid across the top of the accessory and the spectrum of the film is measured within a short time period. The 30Spec includes sample masks of 3/8", 1/4" and 3/16" to define specific sampling areas. The 30Spec provides high-quality FTIR spectra for identification of coatings and can also be used to measure coating thickness. IR throughput is high using the 30Spec due to its relatively simple optical design.

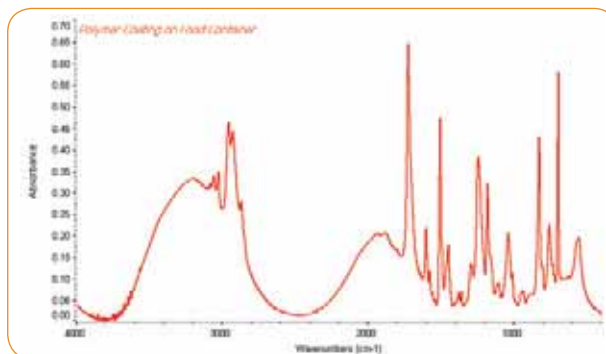

FTIR spectrum of polymer coating on a food container collected using the PIKE 30Spec.

SPECIFICATIONS

Optics	All reflective
Angle of Incidence	30 degrees or 45 degrees
Sample Masks	3/8", 1/4" and 3/16"
Dimensions (W x D x H)	51 x 96 x 77 mm
Mount	2" x 3" slide mount

ORDERING INFORMATION

PART NUMBER	DESCRIPTION
011-1000	30Spec – 30 Degree Specular Reflectance Accessory Includes sample masks (3/8", 1/4", and 3/16"), alignment mirror and slide-mount
011-4500	45Spec – 45 Degree Specular Reflectance Accessory Includes sample masks (3/8", 1/4", and 3/16"), alignment mirror and slide-mount

Note: The 30Spec and 45Spec are slide-mount accessories.

30SPEC AND 45SPEC SAMPLING OPTIONS

PART NUMBER	DESCRIPTION
011-2010	Sample Masks (3/8", 1/4", and 3/16")
300-0039	Aluminum Substrate Alignment Mirror

Note: Sample masks and alignment mirror fit both 30Spec and 45Spec.

80Spec – Grazing Angle Specular Reflectance for Thin Films



FEATURES

- Measurement of thin films and mono-molecular layers
- Fixed 80 degree angle of incidence
- Gold-coated reflective optics for highest throughput grazing angle analysis
- Dual polarizer mounts for incoming and outgoing IR beam
- Optional sample masks version to define unique sampling areas
- Baseplate mount design for stable operation and collection of high-quality spectra – fits all FTIR spectrometers

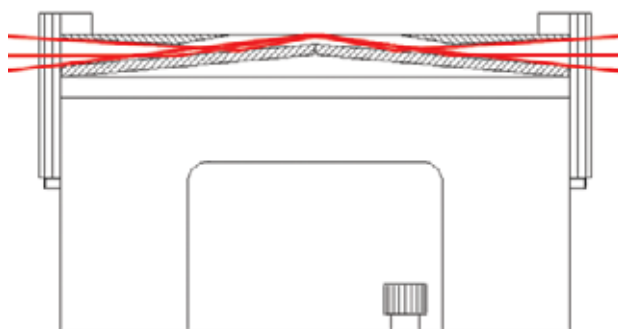

Beam path within the 80Spec specular reflectance accessory.

The PIKE Technologies 80Spec is ideal for the measurement of relatively thin films and mono-molecular layers by specular reflectance. Samples are simply placed face down across the top of the accessory and the spectrum of the film is collected. Generally the measurement of ultra-thin film samples, especially monolayers, is significantly enhanced by using p-polarized light, with the electric field vector perpendicular to the sample surface. The 80Spec includes polarizer mounts on both incoming and outgoing beams for positioning optional manual or automated IR polarizers from PIKE Technologies.

The 80Spec is available in two versions. The basic configuration features a flat sampling surface with fixed sampling port. This version is ideal for analysis of larger, uniform samples. The second version includes three sample masks to define smaller areas on a sample, and is recommended for smaller samples or for measurement of variations in thin film coatings.

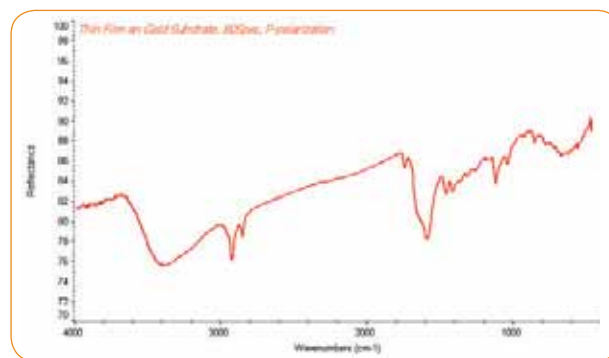

FTIR spectrum of an ultra-thin film on a reflective substrate using p-polarized IR beam.

ORDERING INFORMATION

PART NUMBER	DESCRIPTION
012-10XX	80Spec – 80 Degree Specular Reflectance Accessory Includes a gold substrate alignment mirror, dual polarizer mount and FTIR base mount
012-11XX	80Spec – 80 Degree Specular Reflectance Accessory with Sample Masks (2", 5/8" and 3/8") Includes a gold substrate alignment mirror, dual polarizer mount and FTIR base mount

Notes: Replace XX with your spectrometer's Instrument Code. [Click for List >](#)
For compact-size spectrometers, only one polarizer mount may be included due to sample compartment width restriction. Please contact PIKE Technologies prior to placing an order.

REPLACEMENT PARTS AND OPTIONS

PART NUMBER	DESCRIPTION
010-3010	Specular Mask Set
300-0002	Gold Substrate Alignment Mirror, 1.25 x 3.0"
090-1000	Manual Polarizer, ZnSe
090-1200	Manual Polarizer, KRS-5
090-3000	Precision Manual Polarizer, ZnSe
090-3200	Precision Manual Polarizer, KRS-5
090-5000	Precision Automated USB Polarizer, ZnSe
090-5100	Precision Automated USB Polarizer, KRS-5

Note: For more polarizer options see the polarizer section of this catalog.

AGA – Advanced Grazing Angle Specular Reflectance for Thin Films with Precise Spot Control

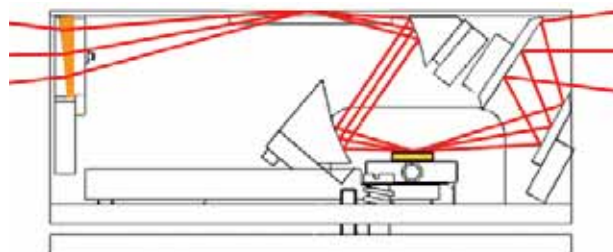

Beam path within the AGA – Grazing Angle Specular Reflectance Accessory.

The beam from the spectrometer is focused onto the pin mirror. The angle of incidence is equal to 80 degrees. The portion of the beam that is reflected from this mirror is imaged at unit magnification onto the sample, striking it at the same 80 degrees. Thus, the beam at the sample position is uniform and circular in dimension – providing excellent quantitative results for the defined sample area.

FEATURES

- Quantitative measurement of small areas of thin films and mono-molecular layers
- Fixed 80 degree angle of incidence
- Measurement of lubricants on hard disks
- Sampling dimensions selectable from 1/2", 3/8", 1/4", 3/16" and 1/8" diameter
- Polarizer mount for optional polarizer
- Baseplate mount design for stable operation and collection of high-quality spectra – fits most FTIR spectrometers
- Spectral range 10,000–500 cm⁻¹

The PIKE Technologies AGA – Advanced Grazing Angle Specular Reflectance Accessory is a novel instrument designed for quantitative measurement of spatially defined areas of thin films on reflective substrates. Traditional grazing angle accessories produce a sampling area which is elliptical in shape and non-uniformly illuminates the sample area. This large asymmetrical sampling area causes problems when quantitative analysis are to be performed on small sample areas. The Advanced Grazing Angle (AGA) Accessory has been designed to overcome this deficiency.

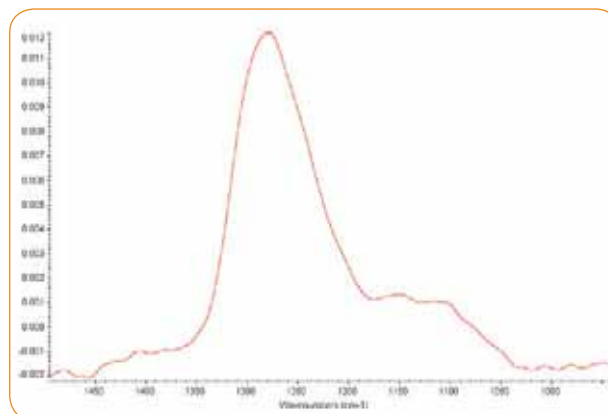

FTIR spectrum of an 18-angstrom thick lubricant on a hard disk measured in 15 seconds using an MCT detector.

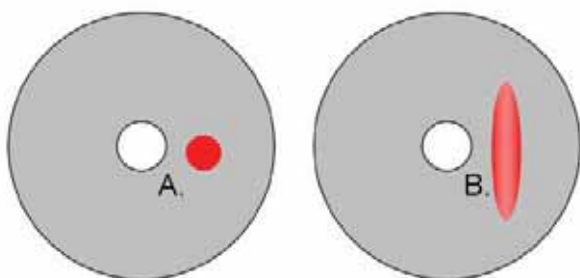

Sampling image on a hard disk surface produced by (A) the spatially resolved AGA and (B) a traditional grazing angle accessory.

The size and shape of the illuminated spot on the sample is defined by the optics contained in the accessory. The AGA optical design uses primary imaging from one of five user-defined, slide-mounted pin mirrors selectable from 1/2" to 1/8".

ORDERING INFORMATION

PART NUMBER	DESCRIPTION
015-10XX	AGA – Grazing Angle Specular Reflectance Accessory Includes 5 selectable spot sizes of 1/2", 3/8", 1/4", 3/16" and 1/8", gold substrate alignment mirror, polarizer mount and FTIR base mount

Note: Replace XX with your spectrometer's Instrument Code. [Click for List >](#)

REPLACEMENT PARTS AND SAMPLING OPTIONS

PART NUMBER	DESCRIPTION
300-0002	Gold Substrate Alignment Mirror, 1.25 x 3.0"
090-1000	Manual Polarizer, ZnSe
090-1200	Manual Polarizer, KRS-5

Note: For more polarizer options see the polarizer section of this catalog.

Absolute Reflectance Accessory – Measure Absolute Sample Reflectance

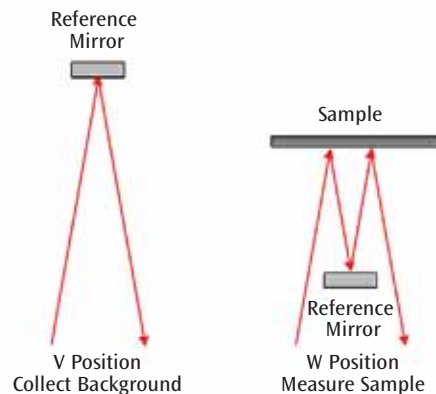

Beam path for V and W positions for the PIKE Absolute Reflectance Accessory.

FEATURES

- For the measurement of absolute reflectance of optical surfaces, windows and metallic surfaces
- Performance evaluation of optical elements
- Evaluation of test plates in medical, industrial and military applications
- Fixed 12 degree angle of incidence

Sample reflectance is usually measured in comparison to a high-reflectance diffuse gold or specular gold mirror. The sample reflectance is measured and calculated against these standards that have 94–99% reflectance in the infrared region.

Absolute reflectance measurement has to be even more accurate than measured by other relative specular accessories. Unfortunately, no standards exist today that have guaranteed 100% reflectance, against which unknown samples could be compared. PIKE Technologies has developed an Absolute Reflectance Accessory which does not require reflectance standards due to its unique V / W optical arrangement. The beam in the V position reflects from the reference mirror. In the W position it is reflecting from the sample twice and the same reference mirror at 12 degrees. The absolute reflectance of a sample is the square root of the measured value at a given wavenumber or wavelength. The two configurations are easily selected by rotating the sample holder 180 degrees with its pinned-in-place mount and the sample is held by a quick-release mount.

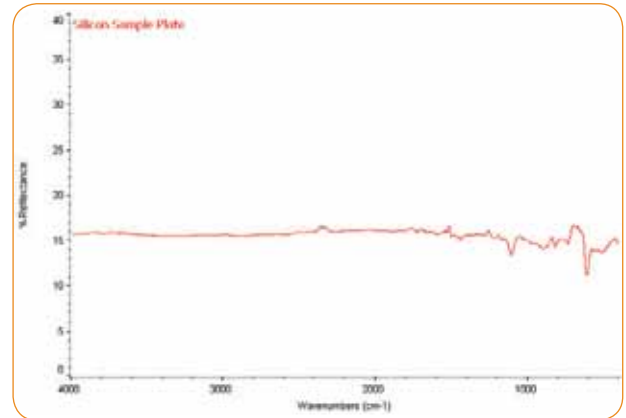

Spectrum of an Si plate measured in the Absolute Reflectance Accessory.

ORDERING INFORMATION

PART NUMBER	DESCRIPTION
014-10XX	Absolute Reflectance Accessory Includes V / W sample holder, gold substrate mirror and FTIR base mount

Note: Replace XX with your spectrometer's Instrument Code. [Click for List >](#)

REPLACEMENT PARTS AND SAMPLING OPTIONS

PART NUMBER	DESCRIPTION
300-0061	Gold Substrate Alignment Mirror (2" x 3")

SPECIFICATIONS

Optics	All reflective
Angle of Incidence	12 degrees
Optical Configuration	V / W
Purge Sealing	Purge tubes and purge barb included
Dimensions (W x D x H)	165 x 241 x 146 mm
Sample Holder Opening	Oval, 40 mm (W) x 22 mm (H)
FTIR Compatibility	Most, specify model and type

Specular Reflectance – Theory and Applications

Specular reflectance sampling in FTIR represents a very important technique useful for the measurement of thin films on reflective substrates, the analysis of bulk materials and the measurement of mono-molecular layers on a substrate material. Often this technique provides a means of sample analysis with no sample preparation – keeping the sample intact for subsequent measurements.

The basics of the sampling technique involve measurement of the reflected energy from a sample surface at a given angle of incidence. The electromagnetic and physical phenomena which occur at and near the surface are dependent upon the angle of incidence of the illuminating beam, refractive index and thickness of the sample and other sample and experimental conditions. A discussion of all of the physical parameters and considerations surrounding the specular reflectance sampling technique is beyond the scope of this overview. We will present this technique from an applications-oriented perspective.

Types of Specular Reflectance Experiments

- Reflection-absorption of relatively thin films on reflective substrates measured at near-normal angle of incidence
- Specular reflectance measurements of relatively thick samples measured at near-normal angle of incidence
- Grazing angle reflection-absorption of ultra-thin films or mono-layers deposited on surfaces measured at a high angle of incidence

In the case of a relatively thin film on a reflective substrate, the specular reflectance experiment may be thought of as similar to a “double-pass transmission” measurement and can be represented as shown in the following illustration.

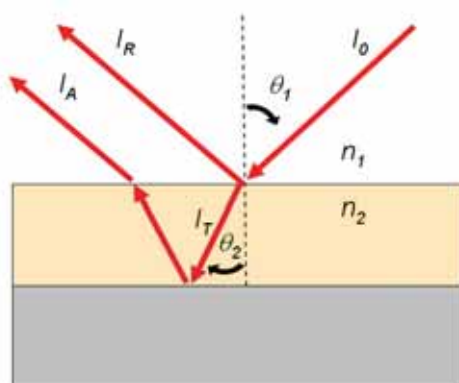

Beam path for reflection-absorption of a relatively thin film measured by specular reflectance.

The incident FTIR beam represented by I_0 illuminates the thin film of a given refractive index (n_2) and at an angle of incidence (θ_1). Some of the incident beam is reflected from the sample surface, represented by I_R at the incident angle (θ_1) and is also known as the specular component. Some of the incident beam is transmitted into the sample represented by I_T at an angle of θ_2 – calculated from Snell's Law.

$$n_1 \sin \theta_1 = n_2 \sin \theta_2$$

At the reflective substrate, the beam reflects back to the surface of the thin film. When the beam exits the thin film it has geometrically passed through the film twice and is now represented as I_A . Infrared energy is absorbed at characteristic wavelengths as this beam passes through the thin film and its spectrum is recorded. The specular reflectance spectra produced from relatively thin films on reflective substrates measured at near-normal angle of incidence are typically of high quality and very similar to spectra obtained from a transmission measurement. This result is expected as the intensity of I_A is high relative to the specular component (I_R).

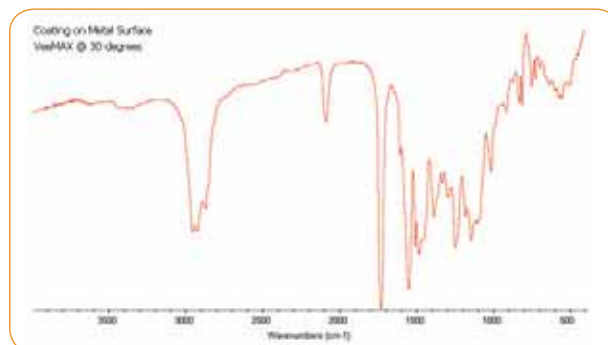

Spectrum of thin film coating on a metal surface measured at 30 degrees angle of incidence using the VeeMAX III specular reflectance accessory.

For relatively thick samples, the specular reflectance experiment produces results which require additional considerations as the specular component of the total reflected radiation is relatively high.

Again, the incident FTIR beam represented by I_0 illuminates the sample of a given refractive index (n_2) and at an angle of incidence (θ_1). Some of the incident beam is reflected from the sample surface, represented by I_R at the incident angle (θ_1). Some of the incident beam is transmitted into the sample represented by I_T at an angle of θ_2 . As predicted by Fresnel equations, the percent of reflected versus transmitted light increases with higher angles of incidence of the illuminating beam. Furthermore, the refractive index of the sample, surface roughness, and sample absorption coefficient at a given wavelength all contribute to the intensity of the reflected beam.

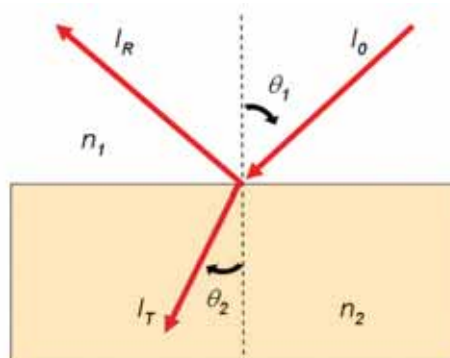

Beam path for a relatively thick sample measured by specular reflectance.

At wavelengths where the sample exhibits a strong IR absorption, the reflectivity of the sample increases. The superposition of the extinction coefficient spectrum with the refractive index dispersion results in a spectrum with derivative-shaped bands. This specular reflection spectrum can be transformed using the Kramers-Kronig conversion to a transmission-like spectrum as shown in the example below.

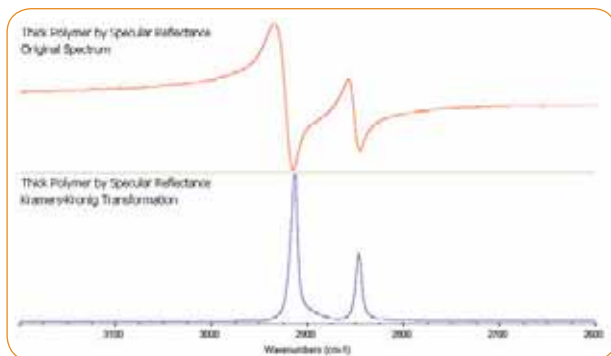

Spectrum (upper – original) of a relatively thick polymer sample measured at 30 degrees angle of incidence using the VeeMAX III; the lower spectrum has been transformed using the Kramers-Kronig software algorithm and is very similar to a transmission spectrum of the polymer polyethylene.

Our third application of specular reflectance is the measurement of relatively thin films and mono-molecular layers at grazing angle of incidence. At high angles of incidence, between 60 and 85 degrees, the electromagnetic field in the plane of the incident and reflected radiation is greatly increased relative to a near-normal angle of incidence. The perpendicular component of the electromagnetic field of the reflecting radiation is not enhanced.

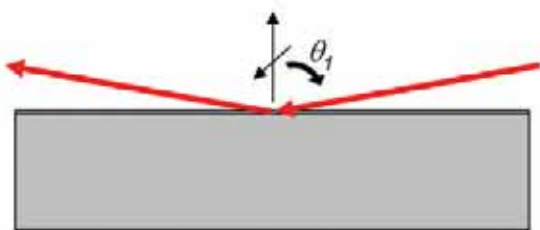

Grazing angle specular reflection analysis produces a strong electromagnetic field oriented in the plane of the incident and reflected radiation.

Because of the orientation of the electromagnetic field at the surface for grazing angle measurements, the use of an IR polarizer greatly improves the sampling result. By collecting the spectrum at grazing angle of incidence with p-polarization, we only examine the enhanced portion of the electromagnetic field at the sample surface, thereby producing a stronger absorbance spectrum.

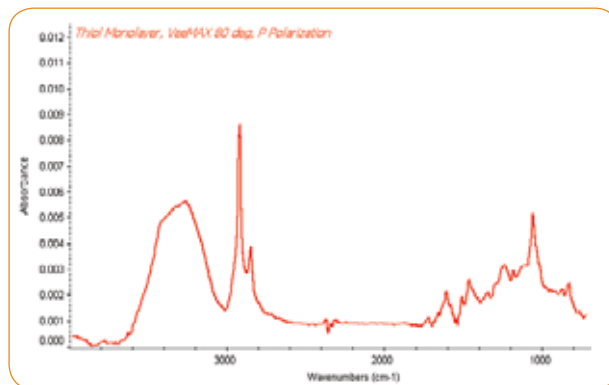

Grazing angle specular reflection analysis of a thiol mono-molecular layer deposited on a gold-surfaced mirror using the PIKE VeeMAX III at 80 degrees and p-polarization; the FTIR was equipped with an MCT detector.

Specular reflectance is a valuable FTIR sampling technique for the analysis of thin films on reflective substrates, for relatively thick films on reflective materials and for bulk materials where no sample preparation is preferred. PIKE Technologies offers a complete line of specular reflectance accessories to perform these analyses.



POLARIZATION

Polarizers may be used to detect oriented samples and for measurement of thin films on reflective substrates. We offer several crystal forms of polarizers and automated versions for transmission, reflection and ATR sampling covering the Vis, NIR, mid-IR and far-IR regions.



Manual Polarizers [Page 62](#)
7 different offerings for mid-IR, NIR and far-IR spectroscopy

Automated Polarizers [Page 62](#)
Motorized polarizers for precision and efficient measurements



THEORY AND APPLICATIONS
[Page 63](#)

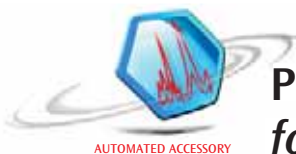

Polarizers – Manual and Automated Versions for Molecular Spectroscopy



FEATURES

- Convenient, slide-mount design for all FTIR spectrometers
- Compatible with many PIKE Technologies accessories
- Available in manual and automated versions
- Elements for NIR, mid-IR, and far-IR applications

PIKE Technologies polarizers are used for a wide variety of spectroscopy applications. Manual or automated versions are available covering the NIR, mid-IR and far-IR regions. New to our offerings is a NIR nanowire polarizer with ultra-high contrast. All polarizers fit into a standard 2" x 3" slide mount and are compatible with FTIR spectrometers. Polarizer elements are 25 mm in diameter and, with mount, have a 20-mm clear aperture.

The polarizers are also compatible with many PIKE Technologies accessories including the 80Spec, VeeMAX, RotatIR and AGA specular reflectance accessories. If you would like to add mounting to any of our accessories, including ATR, please contact us.

PIKE automated polarizers provide specifications identical to our manual versions, plus they are fully computer controlled, making many previously labor-intensive applications feasible. With the automated polarizer an analysis program can be set up through PIKE AutoPRO software to automatically collect all spectra at user-specified polarizer settings.

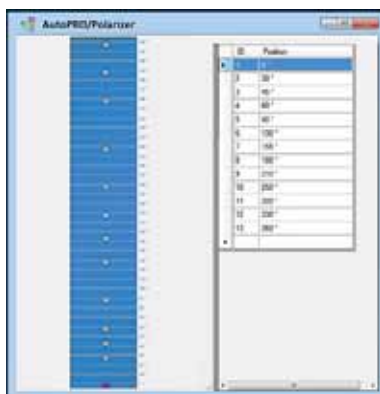

PIKE AutoPRO software configured for the automated polarizer.

There are two manual polarizer types available. The short form has 5-degree scale resolution and the long form (Precision) offers the more precise, 1-degree scale. Automated polarizers increase reproducibility with accuracy to +/- 0.5 degree.

SPECIFICATIONS

Element Type	ZnSe, KRS-5, Ge, CaF ₂ , Glass BaF ₂ , Polyethylene
Element Diameter	25 mm
Clear Aperture Diameter	20 mm
Dimensions (W x D x H)	
Manual	50 x 86 x 9 mm (NIR glass manual polarizers are 17-mm thick)
Precision Manual	50 x 142 x 9 mm
Automated Precision	50 x 146 x 55 mm

ORDERING INFORMATION

MANUAL POLARIZERS

(select based upon spectral range and performance requirements)

PART NUMBER	DESCRIPTION
090-1000	Manual Polarizer, ZnSe
090-1200	Manual Polarizer, KRS-5
090-1500	Manual Polarizer, Ge
090-1400	Manual Polarizer, BaF ₂
090-1600	Manual Polarizer, Polyethylene
090-1300	Manual Polarizer, CaF ₂
190-2002	Manual Polarizer, Glass
090-3000	Precision Manual Polarizer, ZnSe
090-3200	Precision Manual Polarizer, KRS-5
090-3500	Precision Manual Polarizer, Ge
090-3400	Precision Manual Polarizer, BaF ₂
090-3600	Precision Manual Polarizer, Polyethylene
090-3300	Precision Manual Polarizer, CaF ₂
190-2000	Precision Manual Polarizer, Glass

Note: All manual polarizers are mounted into a 2" x 3" plate for use with the FTIR spectrometer slide sample holder or the appropriate sampling accessory. Contact us for a mount for your PIKE ATR accessory.

AUTOMATED POLARIZERS

(select based upon spectral range and performance requirements)

PART NUMBER	DESCRIPTION
090-5000	Precision Automated Polarizer, ZnSe, USB
090-5100	Precision Automated Polarizer, KRS-5, USB
090-5400	Precision Automated Polarizer, Ge, USB
090-5300	Precision Automated Polarizer, BaF ₂ , USB
090-5500	Precision Automated Polarizer, Polyethylene, USB
090-5200	Precision Automated Polarizer, CaF ₂ , USB
190-2005	Precision Automated Polarizer, Glass, USB

Notes: All automated polarizers are mounted into a 2" x 3" plate for use with the FTIR spectrometer slide sample holder or the appropriate sampling accessory. The automated polarizers include the PIKE Technologies Motion Control Unit and AutoPRO software for fully automated operation. Contact us for short form automated polarizers.

Infrared Polarizers – Theory and Applications

Polarizers are valuable tools used for spectroscopic analysis of sample orientation and for measuring thin films on reflective surfaces. This overview presents basic polarization theory and highlights some useful polarization applications.

For the purposes of discussing polarizers, light is considered an electric field with a magnitude oscillating in time. Light propagating along the z axis can be described as a combination of electric vectors in x and y axis. Linearly polarized light may be thought of as consisting of an x and a y component with different relative magnitudes. For example, if the y component is close to zero, the light is considered fully polarized in the x direction.

Polarizers are devices that split unpolarized light into two orthogonal components; one of the linearly polarized components is transmitted, the other is reflected, redirected or absorbed. The most important features of a good polarizer are brightness, contrast and durability. Brightness and contrast can be described by two main parameters; K_1 and K_2 .

K_1 = Transmission efficiency for normally incident polarized light whose electric field vector is perpendicular to the wire direction.

K_2 = Transmission efficiency for normally incident polarized light whose electric field vector is parallel to the wire direction.

For a 'perfect polarizer' $K_1 = 1$, which means full transmission of polarized light whose electric field vector is in the preferred direction and $K_2 = 0$, which means complete blockage of a beam of polarized light whose electric vector is perpendicular to the former. Other measures of performance deduced from K_1 and K_2 are

$$\text{Degree of polarization} = \frac{(K_1 - K_2)}{(K_1 + K_2)}$$

$$\text{Extinction Ratio} = \frac{K_1}{2K_2}$$

$$\text{Principal transmittance ratio or contrast} = \frac{K_1}{K_2}$$

Polarizers may be made from very fine conducting parallel elements or grid placed upon a suitable transparent base material. When the grid spacing is much smaller than the wavelength of light, the light with the electric vector parallel with the grid will be reflected and only the component with perpendicular electric vector will be transmitted (shown graphically on the right).

The overall transmission characteristic of the polarizer depends upon the substrate, but the polarization efficiency depends upon the period, line width and other design parameters of the polarizer.

In the mid-infrared range, the most practical and commonly used polarizers are ruled or holographic wire grid structures. The polarization effect comes from the same principle as the free standing wire grid, except the fine wires are formed on the surface of an infrared transmitting optical window material.

Polarization efficiency depends on smaller grid spacing than the wavelength and on the conductivity of the wires. In the case of a ruled polarizer, the surface of the optical element is created by a diamond needle to form very fine parallel lines, such as 1200 lines/mm, on the surface. The optical element is then placed into a vacuum chamber and this pattern is partially coated with aluminum or other evaporated metallic layer. The spacing between the evaporated thin lines has to be very small, typically a fraction of the wavelength. Ruled polarizers have good performance and are durable at high laser powers, but can only be made on hard, non-granular materials that can be ruled, such as ZnSe.

Holography is another method used to form the fine metallic wire pattern on the surface of the polarizer element. Two coherent laser beams are directed onto the surface of the optical element which is coated with a very thin layer of photo resist. The interference pattern formed at the intersection of the two beams is allowed to expose the photo resist. The lines in between the exposed photo resist are removed and then coated in a vacuum chamber similar to the ruled grating type. The advantage of holographic polarizers is that a wider variety of materials can be used such as the softer KRS-5. As mentioned earlier, the efficiency of the polarizer depends on the grid spacing formed among the wires. Holographic techniques allow more uniform grid patterns because the spacing is produced optically. Light scatter due to imperfections of ruled grooves are also reduced. If the grid spacing is smaller, the polarizer is more efficient. The spacing errors have also much less effect on the efficiency if the grid is much smaller than the wavelength. The trade-off with tighter grid is the reduction of the optical throughput. These parameters are carefully optimized in the design of the polarizer elements and the right polarizer can be selected for specific experimental conditions.

Specifications and performance characteristics of polarizers offered by PIKE Technologies are shown in Table 1.

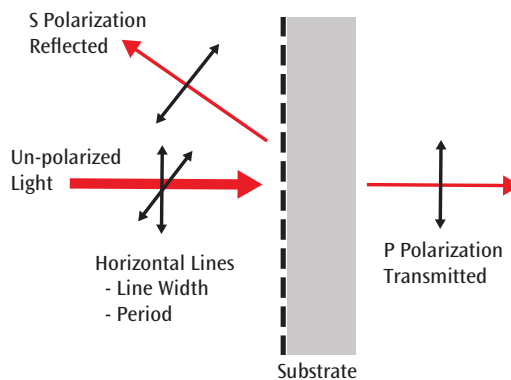

Graphical representation of the polarization effect.

Table 1: Polarizer properties.

Polarizer Type	Application	Cutoff, cm^{-1} Spectral Range	Transmission Efficiency, K_1	Undesired Transmission, K_2	Degree of Polarization, $(K_1 - K_2)/(K_1 + K_2)$
ZnSe	Mid-IR, General Purpose	460	70%	1%	97%
KRS-5	Mid-IR, Wide-range	200	75%	0.25%	99%
Ge	Mid-IR, Highest Efficiency	5500–570	90%	0.25%	99%
Polyethylene	Far-IR, Widest Range	500–10	80%	4%	93%
CaF_2	NIR Applications	800	85%	1%	98%
Glass	Vis/NIR Broadband	20,000–3030	85%	0.05%	99%
BaF_2	Mid-IR	840	70%	0.1%	99%

Notes: Efficiency values reported at 1000 cm^{-1} for mid-IR, at 3300 cm^{-1} for NIR, at 5000 cm^{-1} for glass Vis/NIR and 100 cm^{-1} for far-IR. All polarizers are holographic, wire grid for maximum performance.

The optical material substrate used to create the polarizers determines the wavelength range of the polarizer – such as ZnSe or KRS-5. Table 1 shows the K_1 values of PIKE Technologies polarizers. The maximum transmitted light is affected by the transmission of the materials and the scattering of the ruled and evaporated surfaces. Fresnel losses are determined by the refractive index and the performance of the anti-reflection coating on the element. The maximum transmission compared to a fully depolarized open beam is typically less than 50%. However, FTIR spectrometers produce slightly polarized beams, which in most cases are oriented in the vertical direction in the sample compartment. Thus the apparent transmission of a single polarizer oriented vertically and compared to open beam can be over 50%.

The other critical parameter of polarizers, the contrast, can be measured by crossing two polarizers and recording the throughput signal. For efficient polarizers in a practical spectroscopy setting, such as using a converging infrared beam in the sample compartment of an FTIR spectrometer, it is expected that the light level should be less than 1%. For selected high performance polarizers it can be better than 0.5%.

Polarizers are usually mounted in a plastic disc and placed in a rotating holder with an angle scale. This way, the angle of the polarizer orientation can be positioned with approximately 1 degree repeatability. Motorized polarizers are available with much better angular accuracy and precision. The automated polarizers are also very useful for conducting a series of experiments with different angle settings under complete computer control.

One of the main uses of infrared polarizers is to monitor molecular orientation in samples such as films and fibers. During manufacture polymers tend to orient along the axis of the mechanical stretching and this preferred orientation is retained after the material stops flowing. In some cases, polymers are a mixture of crystalline, more polarized, and amorphous, less polarized, forms of the material. In order to study orientation, polarized light is directed on the film or fiber. The polarized light electrical vector coinciding with the dipole of the infrared active moiety increases in absorption intensity, thereby revealing the band assignment and the orientation of the molecular group. Single crystals placed in the focus of polarized light also absorb selectively, depending on the orientation of the crystal.

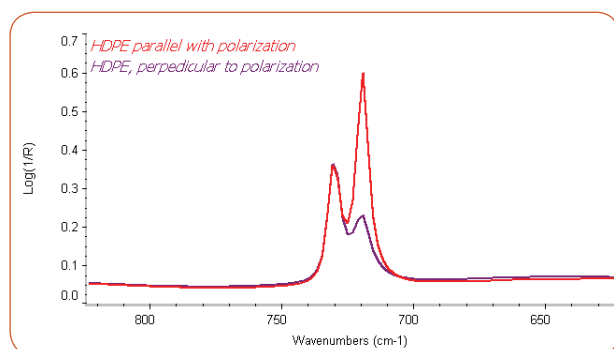

Spectra for high density polyethylene (HDPE) with parallel and perpendicular polarization demonstrate that this sample is oriented.

Polarizers can also be used in conjunction with attenuated total reflection (ATR). Even without polarizers, for any ATR that retains the orientation relative to the incoming infrared beam, there could be spectral differences noted when an oriented sample is placed with its direction along the optical axis or perpendicular to it. The phenomenon is related to penetration depth differences for the light components polarized parallel or perpendicular with the reflective surface (see ATR Theory and Applications).

Another important application of polarizers is the enhancement of the signal measuring thin films on polished semiconductors, metallic mirrors and other reflective surfaces.

Using large angle reflectance optics, the grazing angle reflectance of the thin films can be measured. Substantial signal enhancement can be achieved by using polarized light in conjunction with a grazing angle accessory. As an example, a thin oily deposit on a gold mirror can be measured with good signal-to-noise ratio by using polarized light with a specular reflectance accessory set at 80 degrees. Background spectra for each result were collected at the identical polarization angle as the sample. As seen in the spectra below, the light polarized such that the electric vector is perpendicular to the metallic mirror surface is enhanced. The spectrum measured with the polarization perpendicular to the surface (electric vector parallel with the surface) is not detected. The non-polarized light measurement is a combination of the two polarized measurements, showing a signal with less contrast than the red trace.

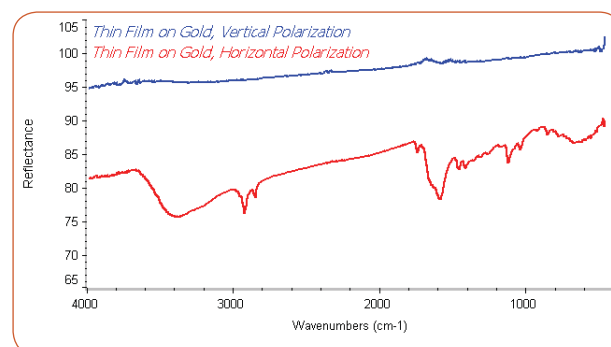

FTIR spectra with vertical and horizontal polarization.

Summary

Polarizers are highly useful spectroscopy sampling tools for the measurement of samples with molecular orientation, for measuring thin films on reflective surfaces and for molecular spectroscopic research.



INTEGRATING SPHERES

Integrating spheres are useful for qualitative and quantitative measurements of sample composition when morphology, particle size, surface roughness or sample flatness varies from sample to sample. PIKE Technologies offers fully integrated accessories for mid-IR and NIR applications.

Mid-IR IntegratIR™ Page 66
Integrating Sphere Accessory
Advanced measurements in the mid-IR spectral region

External IntegratIR™ Page 68
Integrating Sphere Accessory
For large-sized samples

NIR IntegratIR™ Page 69
Fixed 10 Degree Angle of Incidence
Near-normal sample reflectivity measurement



THEORY AND
APPLICATIONS
Page 71

Mid-IR IntegratIR – Integrating Sphere



Upward-looking IntegratIR

FEATURES

- 3-inch sphere – gold-coated, Lambertian scatterer for high-performance measurements
- 12-degree hemispherical diffuse reflectance measurement with specular exclusion port
- Diffuse transmission station for measurement of highly scattering samples in transmission mode
- Choice of integrated, high-performance detector MCT or DTGS for ultimate configurability
- Upward- and downward-looking optical configurations to accommodate a wide range of sample sizes and types
- In-sample-compartment design to minimize laboratory space requirements
- Configurations available for most FTIR spectrometers

The integrating sphere is very often an accessory of choice when studying reflectance properties of solids, analyzing light-scattering and/or highly absorbing samples and collecting spectra difficult to obtain with standard sampling techniques. PIKE Technologies offers mid-IR integrating spheres, designed for research and standard applications that require sensitivity and the ability to collect high-quality data from difficult to analyze samples.

The PIKE IntegratIR™ spheres are available in upward- and downward-looking configurations and are suitable for the measurements of absolute and relative diffuse reflectance of solids, powders and opaque liquids. Each feature a 3-inch diameter highly reflective gold-coated sphere. The accessory mounts in the sample compartment of the FTIR spectrophotometer, and uses a dedicated detector for maximum performance.



Gold-coated Lambertian finish sphere

Both upward- and downward-looking mid-IR spheres feature a 12-degree illumination of the sample, and offers a specular exclusion port. For the upward-looking sphere, reflectance samples are placed directly onto the sample port located on the top of the sphere. This sphere is ideal for large and/or thick solid samples. For powder samples, a standard ZnSe window is available. If preferred, a KBr window can also be used with the sample plate to minimize the reflection loss compared to ZnSe.

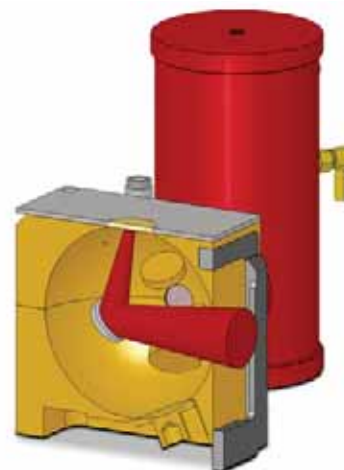

Optical diagram of the upward-looking IntegratIR Sphere.

The downward-looking Mid-IR IntegratIR allows the sample to be placed underneath the sphere. This configuration is desirable for measurements of powders and particulate materials because the incidence beam strikes the sample directly, without passing through an IR transparent window.

For all spheres, the selection of light illumination onto the sample or onto the reference surface is done via a flipper mirror. This allows the background to be collected using either the substitution method or the Taylor method.

Diffuse transmittance of partially transmitting materials can be measured with either sphere. This is done by placing the sample on a standard 2 x 3" sample holder and sliding it in the mount located in front of the transmission port.



Downward-looking IntegratIR

A selection of mercury cadmium telluride (MCT) or deuterated triglycine sulfate (DTGS) detectors is offered with the IntegratIR spheres. This allows the accessory to be optimized for the application and sample type. The wide-band MCT is the commonly configured detector while the less sensitive DTGS is an option for users who require the convenience of a room temperature detector. The MCT detector is approximately 50 times more sensitive compared to the DTGS detector. The accessory comes with built-in detector electronics and interfaces with most FTIR spectrometers. All detectors are pinned in place and interchangeable. For those with both mid- and near-IR spectral capabilities on the FTIR spectrometer an InGaAs detector may be purchased for sensitive NIR diffuse reflection or transmission measurements.

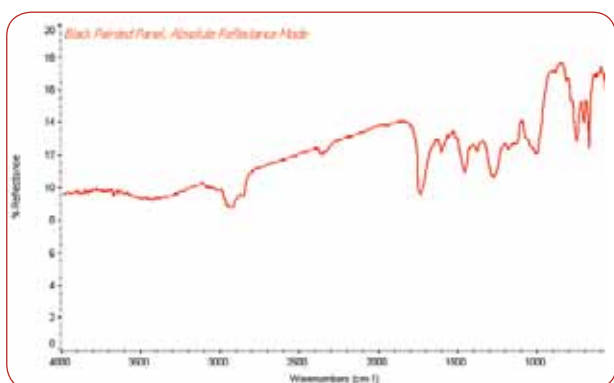

Absolute reflectance spectrum of a painted black panel measured using the PIKE Mid-IR IntegratIR.

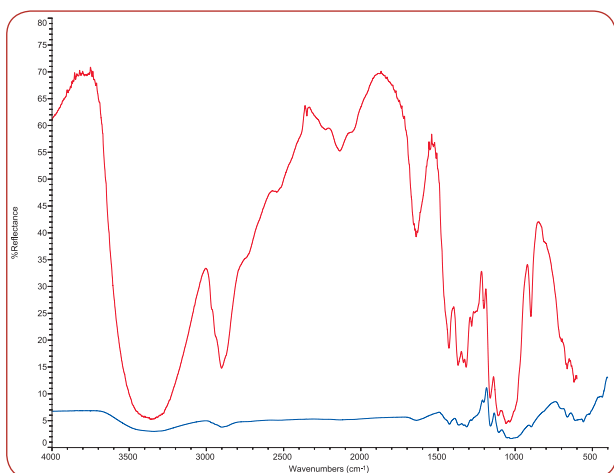

Comparison of transmission spectrum of paper collected using an integrating sphere (red) or in transmission mode without a sphere (blue).

SPECIFICATIONS	
Optical Design	Upward- or downward-looking sample spheres
Angle of Incidence	12 degrees
Sphere Size and Surface	3" (76.2 mm) gold-coated Lambertian surface
Sample Port Size	20 mm
Specular Exclusion Port	Standard
Sphere Dimensions (W x D x H)	159 x 248 x 154 mm (excludes baseplate)
Sample Opening, Downward Sphere (W x D x H)	50.8 x 35.5 x 12.7 mm
Detector Choice	DTGS, MCT or InGaAs
Spectral Range, MCT Detectors	Wide-band: 5000–500 cm ⁻¹ Mid-band: 5000–650 cm ⁻¹ Narrow-band: 5000–800 cm ⁻¹
Spectral Range, Extended DTGS Detector with CsI Window	5000–250 cm ⁻¹
Spectral Range, InGaAs Detector	12,200–3850 cm ⁻¹

ORDERING INFORMATION

PART NUMBER	DESCRIPTION
048-12XX	Mid-Infrared IntegratIR Integrating Sphere Accessory 12-Degree Upward Sample Positioning <i>Includes sphere, purge enclosure and tubing, diffuse gold reference and sample plate with ZnSe window</i>
048-11XX	Mid-Infrared IntegratIR Integrating Sphere Accessory 12-Degree Downward Sample Positioning <i>Includes sphere, purge enclosure and tubing, one diffuse gold reference and powder sample cup</i>

Notes: Replace **XX** with your spectrometer's Instrument Code. [Click for List >](#) Your FTIR spectrometer must be capable of interfacing with an external detector.

DETECTOR CHOICE FOR INTEGRATIR (must select one)

PART NUMBER	DESCRIPTION
048-3350	Wide-band MCT Detector
048-3250	Mid-band MCT Detector
048-3150	Narrow-band MCT Detector
048-3450	DTGS Detector with CsI Detector Window
048-3550	InGaAs Detector

Notes: Detector includes preamplifier electronics. MCT detectors require liquid nitrogen for cooling.

REPLACEMENT PARTS AND SAMPLING OPTIONS

PART NUMBER	DESCRIPTION
048-0108	Sample Plate with 20 x 2 mm ZnSe Window for Upward IntegratIR
048-0208	Sample Plate with 20 x 2 mm KBr Window for Upward IntegratIR
048-3000	Diffuse Gold Reference for Upward IntegratIR
048-3001	Diffuse Gold Reference for Downward IntegratIR
048-2020	Powder Sample Cup for Downward IntegratIR
048-2050	Sample Slide for Downward IntegratIR

External Integrating Sphere – *Precise Reflectivity Measurements*



FEATURES

- Accommodates large-sized sample
- 4-inch sphere – gold-coated, Lambertian scatterer for high performance measurements
- 8-degree hemispherical diffuse reflectance measurement with specular exclusion port
- Manual external translation mirror to switch between the reference and sample position
- Integrated, high-performance MCT detector
- Utilizes external spectrometer beam to allow for the analysis of oversized samples positioned under the sphere
- Fully purgeable enclosure

An integrating sphere is very often an accessory of choice when studying reflectance properties of solids, analyzing light scattering of highly absorbing samples and collecting spectra difficult to obtain with standard sampling techniques. The External Integrating Sphere Accessory, which utilizes the external beam of the spectrometer, is ideal for large samples due to the additional sampling space realized by positioning sample underneath the sphere for precise reflectivity measurements.

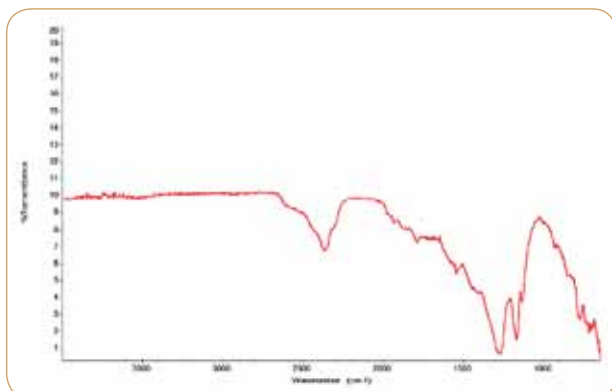

Low reflectivity measurement using the External Integrating Sphere Accessory.

The internal optics of the External Integrating Sphere focus light from the external beam of the spectrometer into a 4-inch gold-plated integrating sphere. A translation mirror is moved manually through a flipper lever located on the external enclosure of the accessory for precise movement between the sample and reference positions. In the sample position, incident light is 8° from normal. Specular reflection may be excluded by opening a port at the top of the sphere. The detector port is 90° from the sample port.

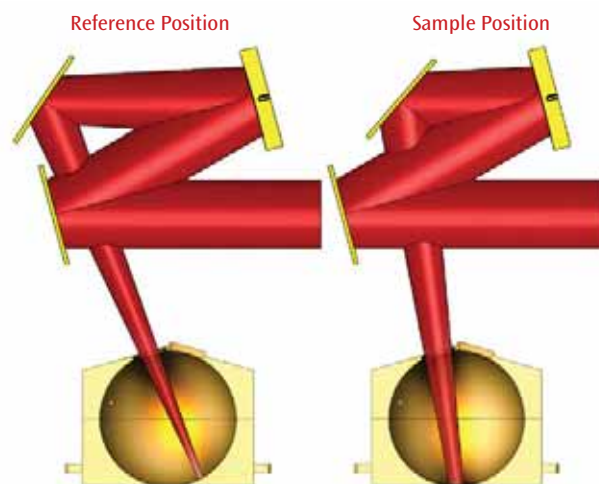

Optical diagram of the FT-IR external beam path for reference and sample positions.

Accurate measurement of both solid- and liquid-phase samples is possible with the 4-inch External Integrating Sphere. By utilizing highly-accurate Taylor methodology for measurement, high-quality components, and sensitive MCT detection, the External Integrating Sphere offers low-noise, highly accurate measurements for a wide range of samples.

ORDERING INFORMATION

PART NUMBER	DESCRIPTION
048-13XXL	Mid-Infrared External Integrating Sphere Accessory — Left Includes sphere, purge enclosure and tubing.
048-13XXR	Mid-Infrared External Integrating Sphere Accessory — Right Includes sphere, purge enclosure and tubing.

Notes: Replace **XX** with your spectrometer's Instrument Code. [Click for List >](#) Accessory uses the spectrometer's external beam. Spectrometer must be equipped to accept an external detector.

DETECTOR (must select one)

PART NUMBER	DESCRIPTION
048-3360	Wide-Band MCT Detector for External Sphere
048-3260	Mid-Band MCT Detector for External Sphere
048-3160	Narrow-Band MCT Detector for External Sphere

OPTIONS

PART NUMBER	DESCRIPTION
048-3000	Diffuse Gold Reference

NIR IntegratIR – Integrating Sphere



The PIKE Technologies NIR IntegratIR™ is a near-infrared (NIR) integrating sphere for quantitative and qualitative measurements of a wide variety of solids and paste materials. The NIR IntegratIR collects reflected energy from a spherical perspective thereby capturing complete and quantitative response from the sample. Using near-infrared chemometrics, qualitative product identification and quantitative analysis may be performed on pharmaceutical, nutraceutical, chemical, polymer, textile, food, agricultural and other samples.

The NIR IntegratIR accessory features a 2-inch high reflectivity gold-coated integrating sphere and an extended range, high-speed, low-noise indium gallium arsenide (InGaAs) detector, transfer optics and interface electronics. The NIR IntegratIR fits into the sample compartment of most commercial FTIR spectrometers and its electronics interface as an external detector of the spectrometer. A 10-mm diameter horizontal sampling port makes the placement of samples onto the accessory easy. An optimized borosilicate window serves as a sampling port at the top of the integrating sphere. The window is bonded and sealed to protect the sphere from corrosive materials and contamination.

Sampling of tablets, packaging materials and plastics is easily accomplished by placing the sample directly on the window of the upward-looking sphere. Powders, creams, pastes or liquids containing reflective particles may be placed in disposable flat-bottom vials – eliminating the need for any sample cleanup. The vials may be held in place by a sample-positioning vial holder, resulting in more repeatable measurements.

High-quality spectra are produced quickly using the NIR IntegratIR – making qualitative and quantitative analysis of a wide variety of sample types efficient and reliable.

FEATURES

- Optimized 2-inch gold-coated integrating sphere with high signal-to-noise ratio
- Fully integrated InGaAs detector, detector electronics and transfer optics
- Optional automated transmission analysis stage for pharmaceutical analysis
- 10-mm horizontal sampling port for easy sample placement
- Excellent qualitative and quantitative NIR analysis tool
- Economical alternative to dedicated near-infrared analyzers
- Optional rotating stage for averaging of heterogeneous samples
- Spectral range 12,200–3850 cm^{-1}
- In-sample-compartment design, compatible with most commercial FTIR spectrometers

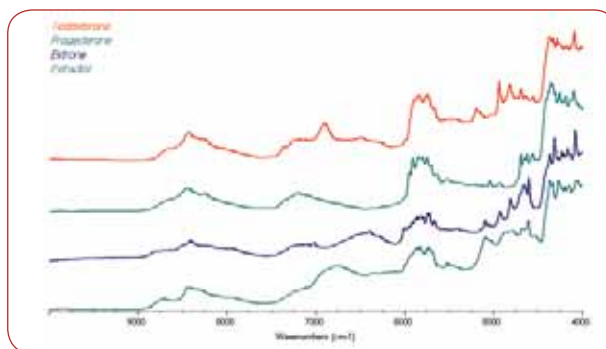

Qualitative analysis of steroids using the PIKE Technologies NIR IntegratIR. Samples are measured within glass vials.

For heterogeneous samples, PIKE Technologies offers a rotating stage for the NIR IntegratIR. With this option, one obtains an averaged result to eliminate variations in quantitative results for the chosen sample area.

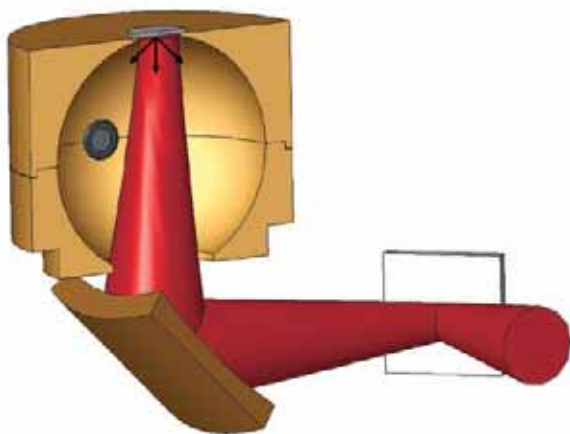

Optical diagram of the NIR IntegratIR.



Rotating stage for beaker

Rotating stage for Petri dish

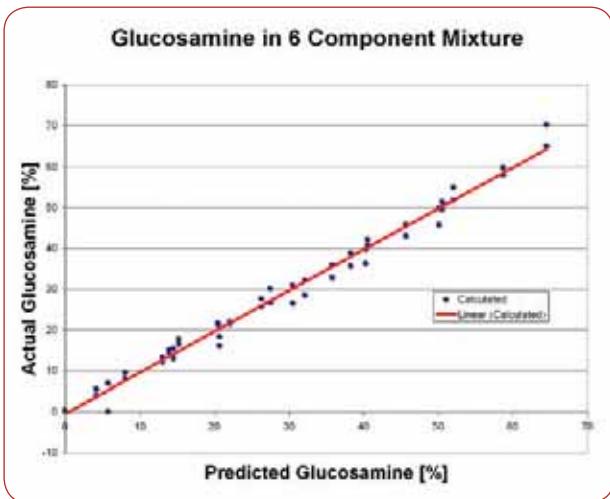

Quantitative measurement of active ingredient in a mixture of magnesium stearate, lactose, EMCOMPRESS®, cellulose and CAB-O-SIL®

The NIR IntegratIR comes complete with diffuse gold reference, sample holders and a removable general-purpose sample mounting plate. It is configured for each specific FTIR spectrometer and includes a pre-aligned mount for your instrument.

The NIR IntegratIR is a cost-effective, high-performance sampling option for laboratories with a standard FTIR spectrometer equipped with a near-infrared light source and beam splitter.

The optional transmission tablet analysis stage (below) for the NIR IntegratIR provides an automated tool for sampling 10 tablets of varying sizes. With this option you can measure formulation reproducibility or verify pharmaceutical composition.



NIR IntegratIR with optional transmission tablet analyzer

ORDERING INFORMATION

PART NUMBER	DESCRIPTION
048-60XX	NIR IntegratIR Integrating Sphere Accessory Includes 2" diffuse gold-coated integrating sphere, InGaAs detector, detector preamplifier, diffuse gold reference, vial holder, and 25 glass vials.

Notes: Replace XX with your spectrometer's Instrument Code. [Click for List >](#)
Your spectrometer must be capable of interfacing with an external detector.

SAMPLING OPTIONS

PART NUMBER	DESCRIPTION
048-3000	Diffuse Gold Reference
162-5483	NIST Traceable NIR Reference Standard
162-5484	NIST Traceable NIR Reference Standard – Recertification
044-3010	Glass Vial Holder for 19-mm vials
048-2999	Glass Sample Vials, 19 x 65 mm (25 ea.)
048-0150	Rotating Stage for Petri dish for heterogeneous samples Includes 100 x 20 mm Petri Dish
048-0151	Rotating Stage Adapter for 500 mL beaker
048-0060	Automated Transmission Tablet Analysis Stage for NIR IntegratIR Includes 3 tablet plates for 7.5, 8.5 and 10-mm tablets

Note: Please contact us for other options. Stage rotates counterclockwise.

Integrating Spheres – Introduction and Theory

Measuring Sample Reflectance

Reflectance sampling accessories rely upon a light beam coming from the spectrometer to be focused upon the sample. In order to achieve the best signal-to-noise ratio (SNR), the smaller the focus is, the easier it is to refocus the illuminated sample spot back onto the detector. In order to measure light reflected at a larger angle, optical designs will allow only a small area of the sample to be projected onto the detector. This arrangement serves well if the sample is microscopically homogeneous, but will result in a larger sample position error. When the sample is moved, the focused beam will see a different portion of the sample resulting in measurement-to-measurement differences. This is called insertion error because the spectrum will be slightly different each time the sample is inserted.

Some industrial or natural samples are inhomogeneous either because they are mixtures of different substances or because they have a particle size comparable to the probing beam diameter. Clearly, if the probing beam could be larger and the reflected light could all be collected, a more representative spectrum could be measured.

Some other samples develop a directional scattering. For example, fibers wound on a mandrel are highly oriented, not just macroscopically as parallel, unidirectional filaments, but also in many cases the molecules of the drawn fibers are oriented within the fiber itself. Such a sample, when placed in a reflectance accessory will generate different results depending on the angle from which the detector is “viewing” the sample. When the overall reflectance needs to be measured reproducibly, for example to measure the concentration of a minor ingredient in the sample, only isotropic optical systems, insensitive to such directionalities could be utilized.

Furthermore, in some cases, not just the reflectance in a small solid angle but the reflectance in all angles is sought. Most reflectance accessories measure at fixed or variable angles, narrower or wider collection angles, but there is a need for a device that uniformly collects all reflected light from a sample. In other words it measures the total reflectance of the sample.

Therefore the main reasons for using integrating spheres for the measurement of sample reflectance are the following:

- Efficient measurement of combined diffuse and specular reflectance
- Uniform detection of reflectance even when the sample is inhomogeneous
- Isotropic detection of reflectance even on samples that reflect in preferred directions
- Reduction of polarization effects from the illuminating beam and the sample
- Measurement of absolute reflectance (with special integrating spheres)

All of the above concerns are addressed with integrating sphere based reflectometers.

Integrating Sphere Optics

Integrating spheres are highly reflective enclosures that are placed in close proximity to the sample, such that the reflected light enters the sphere, bounces around the highly reflective diffuse surface of the sphere wall and finally impinges upon the detector – usually part of the integrating sphere assembly. The name, integrating sphere, refers to one of the main functions of the device, namely that it spatially integrates the light flux, in our application the light reflected from a sample. In spite of the long history of engineering and development of the sphere, the applications and further developments continue to this day. Advances in the theory, detector and electronics development and most of all, new applications, drive the progress.

As the name implies, the main part of the device is a sphere with a very highly reflecting inner surface. The surface should approach the ideal Lambertian scatterer, which means that the light falling on the surface is evenly scattered in all directions and the scattered light intensity is proportional to the cosine of the angle of observation.

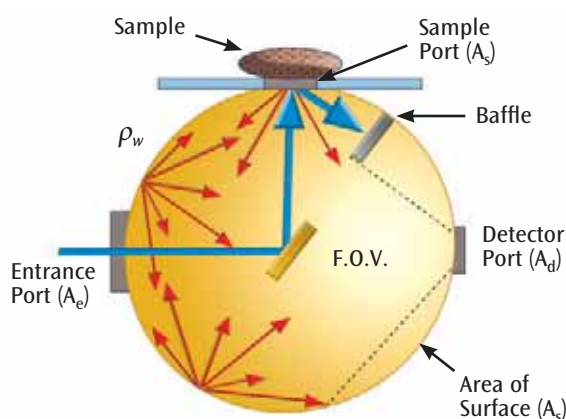

Optical geometry of an integrating sphere.

In an upward-sample-positioning sphere the infrared beam from the interferometer is directed through an entrance port onto the sample placed behind the sample port (shown above). Samples can be directly touching the sphere or separated from the sphere by a thin, infrared transparent window. The detector is placed close to the sphere, so that it can view the integrating sphere with a large solid angle. In order to improve the isotropy (non-directionality) of the detection, the detector is not directly in the line of sight of the sample. A small, also highly reflective and scattering baffle is placed in the sphere such that it blocks the first reflection of the sample from reaching the detector.

A well-designed sphere has the sample close to the sphere geometry so that the sphere will collect close to the full available hemispherical reflectance (2π steradians). A window to separate the sphere and sample may be important in some cases, but it will place the sample a small distance from the sphere, thereby somewhat reducing the collected high-angle reflectance. The PIKE Technologies integrating spheres are coated with the highest possible reflective surface for the desired wavelength region. The coating of the surface of the sphere has to be uniform and close to being a perfect Lambertian scatterer. These characteristics allow the light falling in the sphere to be uniformly distributed over the entire surface of the sphere. It is also important how much of this light is actually collected on the detector surface.

Sphere Throughput

The throughput of a single sphere may be defined as a function of the hemispherical reflectance to the average spherical wall reflectance ratio. The closer the sphere surface is to ideal reflectance, the higher the throughput. The detector, the sample and the illumination require that a portion of the wall of the complete sphere be removed. Smaller cutouts for beam input and output result in higher energy throughput. Due to other considerations, such as reduction of light scatter from the edges of the sphere cutouts, called ports, these have to be optimized and cannot be too small.

The throughput can be expressed with these sphere design parameters:

$$\tau = \frac{A_d}{A_s} \times \frac{\rho_w}{(1 - \rho_{w, \text{avg}})}$$

Where A_d is the detector area, A_s is the sphere area, ρ_w is the sphere wall hemispherical reflectance, $\rho_{w, \text{avg}}$ is the average sphere wall reflectance.

The sphere throughput is higher if the light falling on the detector is increased by the multiple reflections of the light. Another way of looking at the integrating sphere is that it enhances the detector signal by collecting the light, and if the wall surface is reflective enough, bounce it around until it illuminates the detector. The factor that is used to express this gain is called the sphere multiplier (M), which is a function of the wall reflectance (ρ_w), the proportion of the total area of ports to the surface of the sphere (f).

$$M = \frac{\rho_w}{1 - \rho_w(1 - f)}$$

The brightness of the sphere (L_s), using the same amount of input light flux, is dependent on the wall reflectivity, the port-to-sphere surface ratio and the size of the sphere surface.

$$L_s = \frac{\Phi_i}{\pi A_s} \frac{\rho_w}{1 - \rho_w(1 - f)}$$

where Φ_i is the input light flux.

For the sphere the area of the sphere obviously depends on the sphere diameter, and thus the formula shows that a smaller sphere is brighter than one with a larger diameter.

$$L_s \sim \frac{M}{D^2}$$

The sphere diameter cannot be reduced too far however, because the sample diameter will also have to be decreased proportionally when the sphere is smaller. For typical spectroscopic applications the optimum sphere diameter is influenced by the beam size coming from the FTIR spectrometer and the typical sample size of 3–25 mm. Most integrating sphere modules use a 2–4 inch diameter sphere to accommodate the above design parameters. In a practical design, the openings of the sphere need to be kept around 5% for optimum throughput. Wall reflectance is usually between 95–99% and results in a sphere gain of 10–30.

Integrating Spheres for Mid-IR and NIR

Integrating spheres, although much more efficient than an optical system with an equivalent detector position, still have lower throughput than the direct imaging optics. In the visible and NIR spectral region, where there are very good sources and excellent, high-speed detectors are readily available, the SNR is usually not limited by the reduced light level. In the mid-IR spectral region, in order to utilize the above discussed advantages and benefits of integrating spheres, the reduced throughput needs to be offset by the use of the high sensitivity, cooled detectors, such as the liquid nitrogen cooled MCT detector utilized by PIKE Technologies. The near-infrared and mid-infrared measurements using integrating sphere optics have different analytical and measurement goals as well as different features. PIKE Technologies offers both mid-IR and NIR versions.



REMOTE SAMPLING ACCESSORIES

Hollow waveguide and fiber optic sampling accessories provide a new dimension of flexibility – expanding the reach of the sample compartment. The probe is flexible and may be taken to the sample, such as an unwieldy object too large to be placed on an accessory or in a chemical reaction vessel. PIKE offers NIR and mid-IR versions of remote sampling probes.



Mid-IR FlexIR™ [Page 76](#)
Mid-IR Hollow Waveguide Accessory
Remote and flexible sampling in the mid-IR spectral region

NIR FlexIR [Page 77](#)
NIR Fiber Optic Accessory
Remote sampling in the NIR spectral region

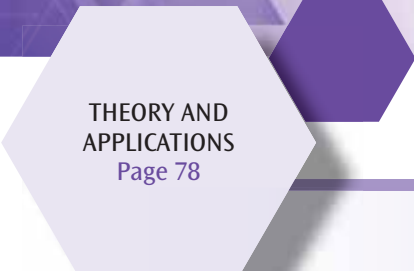

THEORY AND
APPLICATIONS
[Page 78](#)

Mid-IR FlexIR – Hollow Waveguide Accessory for Remote Infrared Sampling



FEATURES

- Fast, easy identification of solids and liquid samples outside of the sample compartment
- 1 or 2 meter, hollow waveguides offer exceptional durability and high throughput
- Full mid-IR spectral range coverage
- ATR, specular and diffuse reflectance probes for a complete array of sampling applications
- Standard and high-temperature/high-pressure probes for reaction monitoring
- Permanent alignment of sampling probe to the hollow waveguide for consistent analysis results
- MCT or DTGS detector choice for maximum sensitivity and convenience
- Compatible with most FTIR spectrometers

The PIKE FlexIR™ Mid-IR Hollow Waveguide Accessory is an excellent tool for remote and specific area analysis of a wide variety of samples. Visible surface contamination, small area material identification and bulky materials too large to fit into the FTIR sample compartment are a few of the many samples and application types for the FlexIR accessory.

The FlexIR is designed for ruggedness and wide spectral range. It utilizes a customized optical design with diamond-turned focus optics providing exceptional IR throughput. The hollow waveguides are very durable and free from the typical fracture problems encountered with polycrystalline core fibers. The highly-reflective hollow waveguides transmit maximum energy through the full mid-IR spectral region – eliminating the need for multiple fibers for complete spectrum coverage when chalcogenide or halide probes are used.

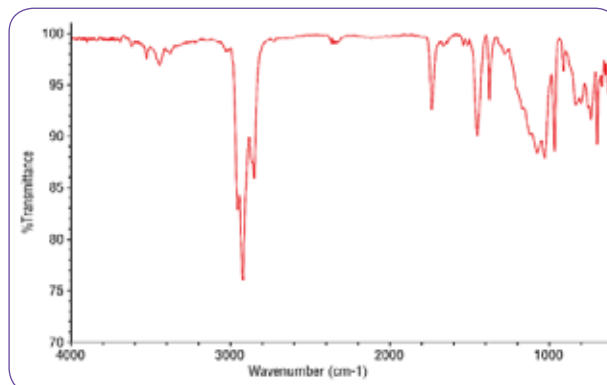

Visible defect on manufactured product – Mid-IR FlexIR accessory with ATR probe.

For maximum configurability two FlexIR bases, with an MCT or DTGS detector, are available. Two detector options serve to optimize the signal-to-noise ratio (SNR) against the required spectral range and the application needs. The mid-band MCT style is the most versatile and common detector offered because of its high sensitivity and fast data collection. A DTGS FlexIR base is available for those applications that do not require a high SNR, and benefit from the flexibility and convenience of a room temperature detector. To optimize its performance, the DTGS detector is integrated into the probe. This probe is equipped with a short handle for ease of positioning and sampling.

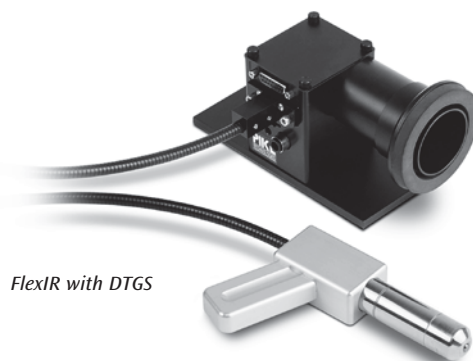

FlexIR with DTGS

For reaction monitoring, the accessory can be equipped with a high-temperature/high-pressure probe. The probe is made of Hastelloy and features a two-reflection diamond ATR crystal. The 6.35-mm shaft diameter and 178-mm length make it suitable for use in a wide variety of reaction vessels. The probe maximum temperature is 150 °C, with maximum pressure up to 8.3 MPa.

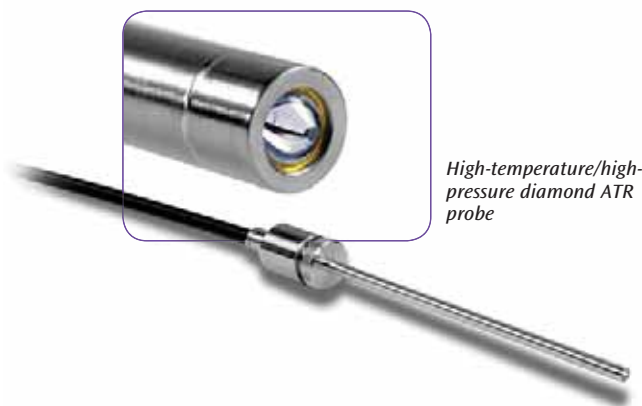

High-temperature/high-pressure diamond ATR probe

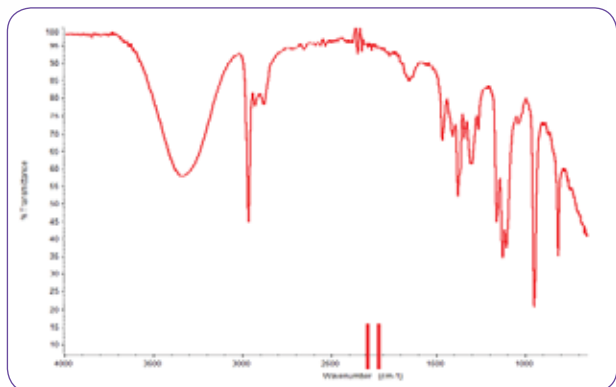

Spectrum of isopropyl alcohol measured using the high-temperature/high-pressure diamond ATR probe.

ACCESSORY SPECIFICATIONS

Optical Design	All reflective, diamond-turned focus optics
Accessory Dimensions, MCT Model (W x D x H)	153 x 132 x 150 mm (excludes FTIR baseplate and mount)
Accessory Dimensions, DTGS Model (W x D x H)	60 x 67 x 80 mm (excludes FTIR baseplate and mount)

SPECTRAL SPECIFICATIONS

Spectral Range ATR	Mid MCT	DTGS
	ZnSe 5000–700 cm ⁻¹	5000–550 cm ⁻¹
	Ge 5000–700 cm ⁻¹	5000–700 cm ⁻¹
	Diamond 5000–700 cm ⁻¹	5000–550 cm ⁻¹
Spectral Range Specular	5000–700 cm ⁻¹	5000–550 cm ⁻¹

PROBE SPECIFICATIONS

Probe Design	Hollow waveguide, full mid-IR reflective
Bend Radius, Minimum	150 mm
HWG Dimensions	1 or 2 m long, 1.6 mm OD, 1.0 mm ID
Diamond ATR Probe	
Probe Body	Hastelloy C-276
ATR Crystal	Monolithic Diamond
ATR Crystal Diameter	4.5 mm
Number of Reflections	2
Maximum Temperature	150 °C (High-Temperature/High-Pressure)
Maximum Pressure	8.3 MPa (1204 psi)
Shaft Dimensions	178 mm length, 6.35 mm diameter
Standard ATR Probes - MCT Version	
Probe Body	Handle: Aluminum Sampling Tip: Stainless Steel
Maximum Sample Depth	60 mm
ATR Crystal Types	Diamond/ZnSe, ZnSe, and Ge
ATR Crystal Diameter	4.5 mm
Maximum Operating Temperatures - MCT Version	Diamond/ZnSe: Ambient ZnSe: 60 °C Germanium: 60 °C
Maximum Operating Temperatures - DTGS Version	Diamond/ZnSe: Ambient ZnSe: Ambient Germanium: Ambient
Specular Reflectance Probe	Gold-coated, 20 degree AOI
Diffuse Reflectance Probe	Gold-coated, 2.5 mm port
Shaft Dimensions of all Standard Probes, MCT	102 mm length, 22 or 12 mm diameter

ORDERING INFORMATION

MID-IR FLEXIR BASE WITH MCT DETECTOR

PART NUMBER	DESCRIPTION
045-30XX	Mid-IR FlexIR Base for MCT Version

Notes: Replace **XX** with your spectrometer's Instrument Code. [Click for List >](#)
 The FlexIR is provided with base optics mounting for the sample compartment of your FTIR spectrometer. An on-board MCT detector must be selected (below). Your FTIR spectrometer must be capable of interfacing with an external detector.

HOLLOW WAVEGUIDE MCT DETECTORS

(must select one)

PART NUMBER	DESCRIPTION
045-3200	Mid-band MCT Detector
045-3100	Narrow-band MCT Detector

PROBES FOR MID-IR FLEXIR WITH MCT DETECTOR

(select one or more)

PART NUMBER	DESCRIPTION
045-4300	Diamond ATR Probe, High-Temperature/High-Pressure, 1 m
045-4100	Diamond/ZnSe ATR Probe, 1 m length, 22 mm diameter
045-4102	Diamond/ZnSe ATR Probe, 2 m length, 22 mm diameter
045-4010	ZnSe ATR Probe, 1 m length, 22 mm diameter
045-4012	ZnSe ATR Probe, 2 m length, 22 mm diameter
045-4050	Ge ATR Probe, 1 m length, 22 mm diameter
045-4052	Ge ATR Probe, 2 m length, 22 mm diameter
045-4030	Specular Reflectance Probe, 1 m length, 22 mm diameter
045-4032	Specular Reflectance Probe, 2 m length, 22 mm diameter
045-4020	Diffuse Reflectance Probe, 1 m length, 22 mm diameter
045-6000	Diamond/ZnSe Probe, 1 m length, 12 mm diameter
045-6100	ZnSe Probe, 1 m length, 12 mm diameter
045-6200	Ge Probe, 1 m length, 12 mm diameter

Notes: Sampling probes are fixed to the hollow waveguides for maximum sampling reproducibility. Diffuse and specular probes are open-tipped and are not suitable for powder or liquid sampling.

MID-IR FLEXIR BASE WITH DTGS DETECTOR

PART NUMBER	DESCRIPTION
045-35XX	Mid-IR FlexIR Base for DTGS Version

Notes: Replace **XX** with your spectrometer's Instrument Code. [Click for List >](#)
 The FlexIR is provided with base optics mounting for the sample compartment of your FTIR spectrometer. Your FTIR spectrometer must be capable of interfacing with an external detector. The DTGS detector is integrated into the probe.

PROBES FOR MID-IR FLEXIR WITH DTGS DETECTOR

(must select one or more)

PART NUMBER	DESCRIPTION
045-5100	Diamond/ZnSe ATR Probe, 1 m
045-5010	ZnSe ATR Probe, 1 m
045-5050	Ge ATR Probe, 1 m
045-5030	Specular Reflectance Probe, 1 m

Notes: Sampling probes are fixed to the hollow waveguides for maximum sampling reproducibility. DTGS detector is integrated into the probe. Specular probe is open-tipped and is not suitable for powder or liquid sampling.

HOLLOW WAVEGUIDE PROBE HOLDERS

PART NUMBER	DESCRIPTION
045-3400	Adjustable Probe Holder
045-3410	Standard Probe Holder

Note: Probe holders may be used with all standard hollow waveguide probes.



NIR FlexIR – NIR Fiber Optic Accessory for Fast and Remote Sample Identification



FEATURES

- Fast, easy identification of solids and liquid samples in situ
- 2 meter, low-OH fibers providing exceptional throughput and excellent spectral data with short analysis time
- Spectral range from 1.0 to 2.5 microns (10,000 to 4000 cm^{-1})
- Integrated, high-sensitivity, extended range InGaAs detector with electronics connection for your FTIR spectrometer
- Standard SMA connectors providing maximum flexibility with fiber probes
- Standard diffuse reflectance sampling tip with inert sapphire window for solid samples
- Optional transmittance sampling tip for liquid samples
- Compatible with most FTIR spectrometers configured for NIR operation

The PIKE Near-IR (NIR) FlexIR™ fiber optic accessory is an excellent tool for remote and speedy analysis of a wide variety of materials. Powders, plastics, coatings, and liquid samples are readily measured – typically within 30 seconds. The NIR FlexIR is ideal for performing incoming QC of materials used in pharmaceutical, polymer and chemical manufacturing.

NIR sampling is fast and efficient as it eliminates the need for sample preparation. The NIR FlexIR accessory further speeds analysis since the probe tip simply contacts the sample, often in drums, and the spectrum is collected. Powdered samples packaged within a plastic bag can be analyzed without removal from the bag, which further speeds analysis time and eliminates analyst exposure to chemical materials.

The NIR FlexIR is designed for maximum throughput and performance. The fiber optic cable is directly coupled to the integrated indium gallium arsenide (InGaAs) detector – eliminating energy loss due to additional transfer optics and beam divergence.

With the optional Liquids Sampling Tip, it is easy to identify incoming liquids by inserting the wand tip into the liquid sample and collecting its spectrum.

The NIR FlexIR accessory is built and tested for optimum performance for your FTIR spectrometer.

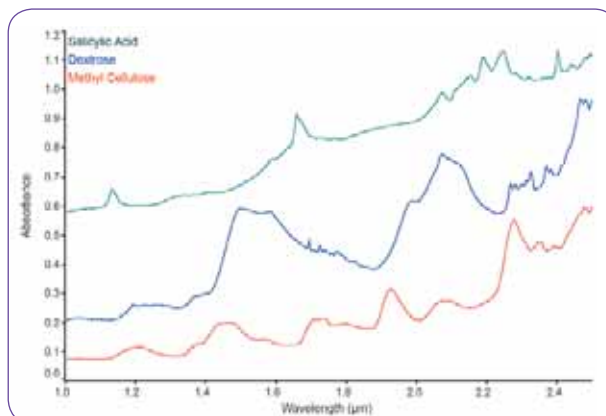

Spectra of incoming pharmaceutical materials measured and verified with the NIR FlexIR accessory.

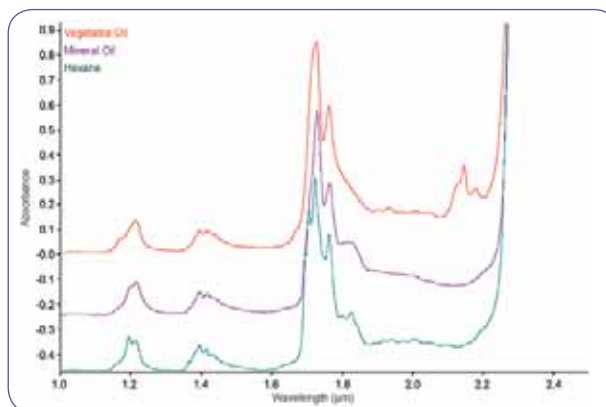

Spectra of incoming liquid materials measured and verified with the NIR FlexIR accessory.

ORDERING INFORMATION

PART NUMBER	DESCRIPTION
045-10XX	FlexIR NIR Fiber Optic Accessory <i>Includes base optics mounting for the sample compartment of your FTIR spectrometer, electronic cabling, diffuse reflectance probe and probe stand.</i>

Notes: Replace **XX** with your spectrometer's Instrument Code. [Click for List >](#)
Your FTIR spectrometer must be configured with NIR beamsplitter and NIR source for optimum performance of the FlexIR accessory. Your FTIR spectrometer must be capable of interfacing with an external detector.

SAMPLING OPTIONS

PART NUMBER	DESCRIPTION
045-2001	Liquids Sampling Tip for FlexIR, 1.0 mm pathlength
045-2000	Liquids Sampling Tip for FlexIR, 1.5 mm pathlength
045-2002	Liquids Sampling Tip for FlexIR, 2.0 mm pathlength

Note: The Liquids Sampling Tip is screw-mounted and easily exchanged with the solids sampling tip on the FlexIR sampling probe.

REPLACEMENT PARTS

PART NUMBER	DESCRIPTION
045-2010	Diffuse Reflectance Tip for NIR FlexIR probe
045-7051	NIR FlexIR Probe Stand

Mid-IR Remote Sampling – Introduction and Applications

Fourier transform infrared (FTIR) remote sampling offers a viable solution for the analysis of samples which are not conducive to the use of traditional FTIR sampling accessories due to constraints posed by the size of a bench-top instrument's sample compartment or the nature of the sample. Taking an IR probe to a sample is desirable in numerous applications and a necessity in others. Examples of remote IR sampling may be found across many fields. In the fine arts, priceless paintings and artifacts may be analyzed with limited sample handling. Mid-IR analysis of intractable samples such as large painted panels may be conducted. Biomedical applications encompass soft tissue and skin analysis. In chemical production, remote sampling allows for reaction monitoring and the analysis of samples restricted to glove boxes and fume hoods.

PIKE Technologies offers the next generation of commercially-available FTIR remote sampling accessories with the Mid-IR FlexIR. Hollow waveguides (HWGs), the cornerstone of these mid-IR remote sampling accessories, offer enhanced performance characteristics compared to traditional mid-IR optical fibers. The most popular type of HWGs consists of reflective coated silica tubing. The inner portion of silica tubing is coated with Ag followed by converting some of the Ag to AgI to form a dielectric layer, which exhibits a highly reflective and very smooth surface. The exterior of the silica tubing is coated with acrylate polymer to provide additional strength.

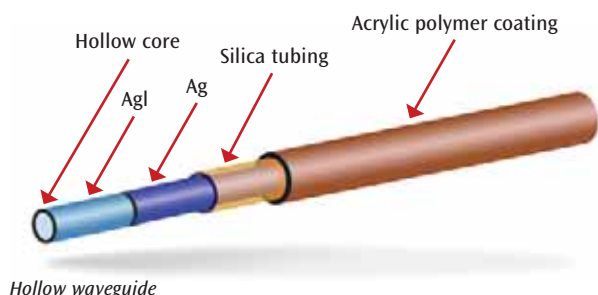

HWGs used in the design of the Mid-IR FlexIR accessory address many of the limitations found with the use of traditional chalcogenide glass and silver halide polycrystalline fibers. Chalcogenide fibers exhibit a strong absorption band located near 2170 cm^{-1} due to S-H or Se-H bonds; as a consequence, the signal-to-noise ratio (SNR) in this spectral region is significantly decreased. To address this issue, two different fiber types, chalcogenide and silver halide, are often employed to generate a full spectral range. The chalcogenide fiber generally used in mid-IR spectroscopy covers approximately $6500\text{--}2250\text{ cm}^{-1}$ and $2050\text{--}1000\text{ cm}^{-1}$ while the silver halide fiber covers $2100\text{--}600\text{ cm}^{-1}$. In contrast, HWGs are capable of spanning a wide spectral range from $11,000$ to 700 cm^{-1} eliminating the need for a complementary fiber set. The spectral range of the Mid-IR FlexIR accessory is dependent on the probe type and the configured detector.

Durability of traditional fibers has been a concern and a hindrance in past mid-IR remote sampling accessories. Additionally, intrinsic flaws originating during the manufacture of glass fibers significantly increase fiber fragility, and may often result in catastrophic failure under routine application use. Furthermore, the bend radius of traditional fibers are limited. Contrary to these properties, HWGs offer a robust means of delivering and collecting IR radiation and offers a smaller bend radius.

For ultimate flexibility the Mid-IR FlexIR offers a choice of detector, either a liquid nitrogen MCT detector for applications that require high sensitivity or a DTGS detector for applications that require less sensitivity yet desire the convenience of a room temperature detector. Two models of MCT detectors are available (narrow-band and mid-band) to allow the optimization of signal-to-noise ratio and spectral range. The MCT detector is mounted on the base optics while the DTGS detector is nested in the probe tip.

The sample probe is permanently aligned to the HWG for consistent analysis results. A variety of probes are available covering ATR, diffuse reflectance, and specular reflectance sampling techniques. Three ATR crystal offerings are zinc selenide (ZnSe), germanium, and diamond/zinc selenide composite. Fiber length is 1 or 2 m.

To illustrate the diverse capabilities of the newest technology in mid-IR remote sampling – the Mid-IR FlexIR, three application examples will be presented highlighting applications using attenuated total reflectance (ATR), diffuse reflectance and specular reflectance sampling probes.

Biomedical Application: ATR Probe

The simplicity of ATR sampling has led to its use in numerous biomedical applications. Confining the ATR crystal sampling surface to an FTIR sample compartment limits *in vivo* studies.

Remote ATR sampling, however, expands the flexibility of FTIR studies and applications in this field. For example, remote ATR sampling makes it possible to investigate chemical diffusion through the skin, residual chemicals retained on the skin from body lotions and washes and the investigation of skin aberrations.

The objective of this biomedical application was to investigate residual chemicals found on human skin after the application of a commercially-available sunscreen spray. A spectrum was collected before and after the application of the skin care product using the FlexIR ZnSe ATR probe.

Spectral data of untreated skin clearly shows the IR chemical signature of skin including the amide I and amide II bands at 1650 and 1550 cm^{-1} , respectively. The result from spectral subtraction allows for the investigation of the sunscreen chemicals remaining on the skin (Figure 1). Capabilities of collecting *in vivo* data allow for the optimization of formulations and the study of time-based efficacy of existing products and those in the product development stage.

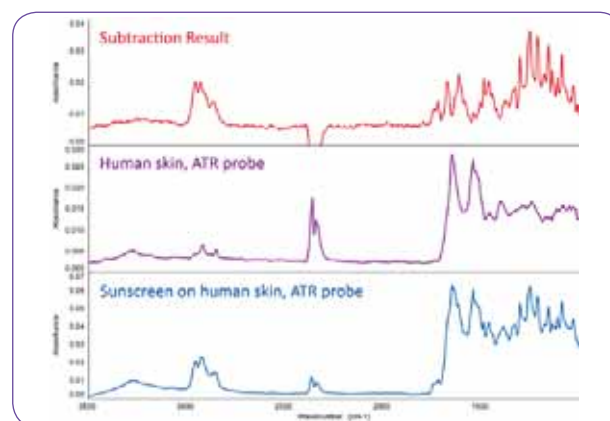

Figure 1. Spectra of untreated and treated skin.

**Intractable Panels:
Diffuse Reflectance and Specular Reflectance**

Reflective-type measurements may be classified as either diffuse or specular. Coatings and thin films on reflective substrates are candidates for specular reflectance measurements. Using this sampling technique, the reflected beam from the sample is collected at an angle of incidence equal to that of the incoming beam as it is delivered to the sample. Diffuse samples scatter the reflected beam across a wide range of angles and in IR sampling must be gathered using a collection optic.

To illustrate non-destructive mid-IR testing using remote sampling, two intractable samples were analyzed. One sample consisted of a coating on a smooth reflective surface, conducive to specular reflectance measurements. The other sample type had a painted diffuse surface. Figure 2 shows the spectrum of a coating on a smooth reflective surface obtained by using the Mid-IR FlexIR configured with a specular reflectance probe, and Figure 3 shows spectra of painted diffuse panels collected with the diffuse reflectance probe. The two diffuse painted panels clearly show differing chemical properties. In each sample the high SNR results in quality spectra. The spot size of both probes is 2.5 mm in diameter allowing for concise measurements of small defects. Remote sampling offers a convenient method of non-destructive analysis.

Conclusions

HWGs bring new technology to mid-IR remote sampling accessories. The diversity of sampling probes covering ATR, diffuse reflectance and specular reflectance used in conjunction with HWGs and high precision optics offers the capability to collect quality spectra of a wide range of samples, which may be prohibited with traditional in-compartment FTIR sampling accessories.

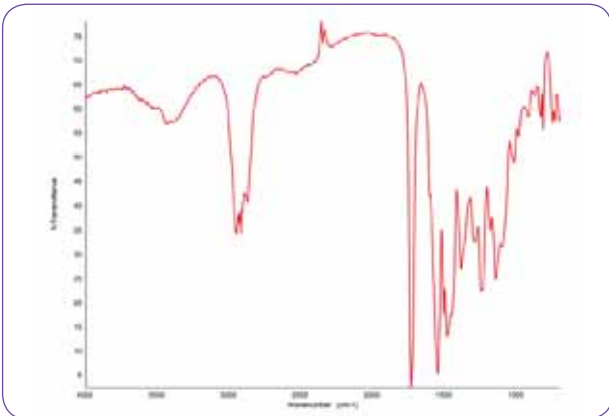

Figure 2. Spectrum of a coating on aluminum.

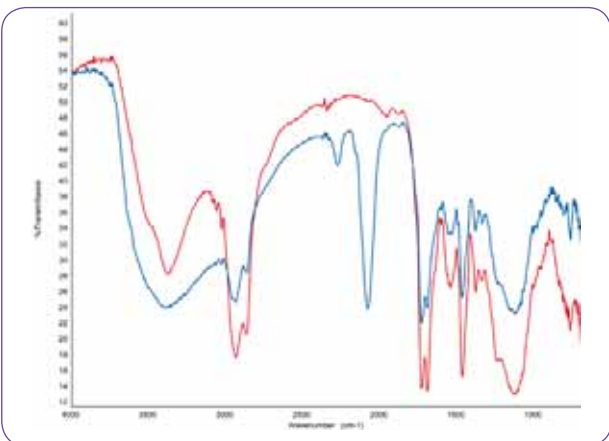

Figure 3. Spectrum of a panel with diffuse finish.



MICROSAMPLING

For samples considerably smaller than a typical 8–10 mm IR beam, microsampling accessories and microhandling tools make ideal additions to your FTIR spectrometer. Our microsampling accessories demagnify the FTIR beam to a smaller dimension, thereby increasing IR throughput for small samples.



μMAX™ FTIR Microscope [Page 82](#)
*Transmission, reflection and ATR analysis
of micro samples*

Microsampling Tools [Page 85](#)
Sample handling tools for microanalysis

Micro Diamond Cell [Page 86](#)
*Compressing and holding samples
for microanalysis*

S-100R Heated Microscope Stage [Page 87](#)
*Temperature measurements under vacuum
or controlled gas flow*

4X and 6X Beam Condensers [Page 88](#)
Transmission measurements of micro samples

μ MAX – Sample Compartment Microscope for FTIR



FEATURES

- Compact sample compartment design to save lab space
- Uses FTIR detectors – DTGS or MCT
- Available in transmission, reflection and ATR modes
- High throughput optical design
- Simultaneously view and collect spectrum
- Easy-to-use, robust design
- Available for most FTIR spectrometers
- Trinocular with USB camera option
- Low-cost

The μ MAX™ is an optical design for IR microanalysis providing high-performance sampling at low-cost with exceptional ease-of-use. The μ MAX fits into the sample compartment of most FTIR spectrometers. The compact, planar optical layout minimizes the pathlength of the IR beam and thereby maximizes IR throughput.

All operations with the μ MAX are intuitive and made even easier with standard **Dichroic Optics** which provides full viewing of the sample while collecting IR spectra. With Dichroic Optics you can view the sample area and simultaneously search for appropriate IR spectral content – greatly speeding microanalysis. The fully variable X, Y, θ see-through aperture for transmission provides optimized sample dimensioning – for getting the maximum IR signal from every sample.

The μ MAX IR microscope uses a 7.45X **Schwartzschild objective and condenser** to focus the IR beam onto the sample and provide excellent sample visualization – better than 1-micron visible image resolution. An optional CCD camera enables video image projection onto the PC. With the Dichroic Optics of the μ MAX and spectral preview of the FTIR software one can view changing IR spectra and sample position in real-time on the PC.

The μ MAX is the first sample compartment IR microscope accessory capable of all **microsampling modes – transmission, reflection and ATR**. The μ MAX fits into the sample compartment, using the spectrometers detector for convenience and sampling flexibility. For relatively larger micro samples (100 microns and greater) the DTGS detector provides excellent performance with the μ MAX and enables full mid-IR spectral range coverage to 450 cm^{-1} . For smaller micro samples to 20 microns in size an MCT detector is recommended.

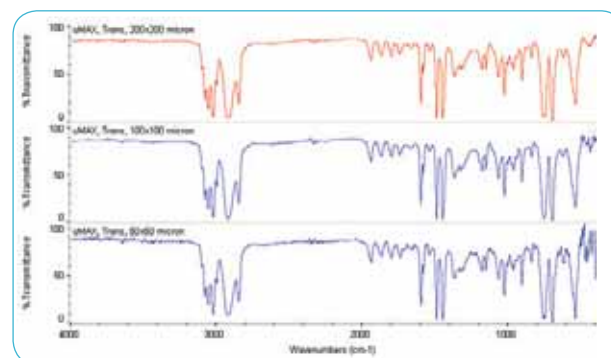

Transmission spectra of polystyrene film at aperture sizes of 200 x 200, 100 x 100, and 50 x 50 microns using the μ MAX IR Microscope and the DTGS detector of the FTIR spectrometer (spectra were collected at 4 cm^{-1} spectral resolution using a 2-minute collection time).

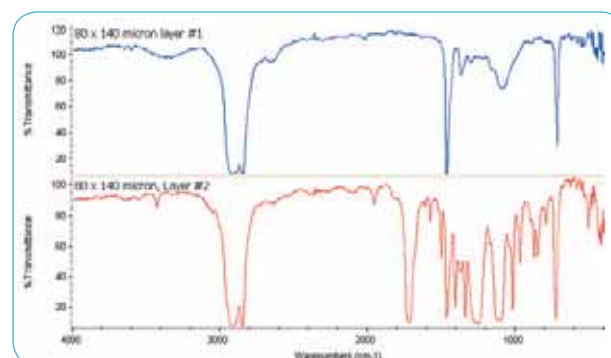

Transmission spectra of polymer laminate sample using DTGS detector. Samples held in PIKE Micro Compression Cell.

Switching from transmission to reflection on the μ MAX is easy with a thumb wheel selection. Reflection sampling area is defined by use of the aperture slide with pre-defined sizes from 40 to 1000 microns. Micro reflection analysis of small areas of interest on reflective surfaces is made easy with the PIKE Technologies μ MAX. Simply focus and position the sampling stage, select the sample area with the aperture slide and collect the spectrum. The background spectrum is collected using the same dimension aperture using the gold-surfaced reference slide.

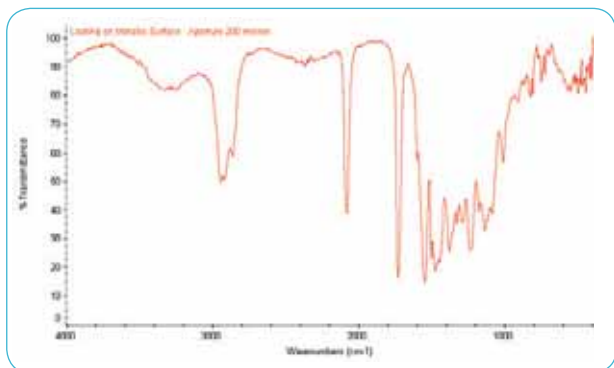

Micro reflection spectrum of a coating on a reflective base metal, 200 x 200 micron sampling area using DTGS detector.

ATR is an excellent sampling option for the μ MAX IR microscope. The RotATR™ is a unique, pivot-designed germanium ATR providing easy and precise operation and excellent micro ATR spectra. Focus and select the sample area, rotate the ATR crystal into sample position, make sample contact and collect the IR spectrum.

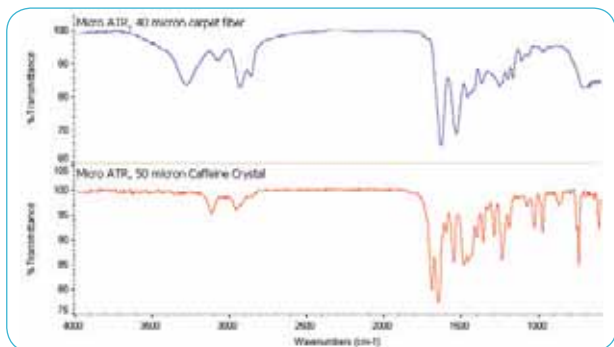

Micro ATR spectra of a 40 micron carpet fiber (upper – blue) and a 50-micron caffeine crystal (lower – red) using DTGS detector.

Micro ATR works exceptionally well with the μ MAX IR microscope. The 100-micron flat-tipped micro ATR crystal makes intimate contact with the sample easily achieved, providing high spectral quality as seen in the data above.



PIKE Technologies Micro Compression Cell

The Micro Diamond Cell is an excellent option for use with the μ MAX IR Microscope. Tiny chips or fiber segments can be flattened to obtain excellent transmission spectra.

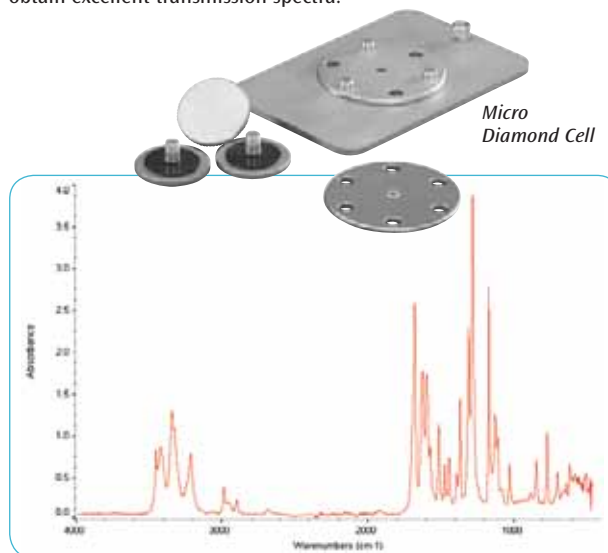

Single drug crystal identified as benzocaine flattened in the Micro Diamond Cell. Data collected using DTGS detector.

SPECIFICATIONS

Sampling Modes	Transmission, Reflection and ATR
Objective	7.45X Schwartzschild, N.A. 0.64, fixed for sturdy, permanent alignment
Optional Condenser	7.45X Schwartzschild, N.A. 0.64, Z-adjust to optimize sample focus
Micro ATR	RotATR with 100 micron tip, pivot pinned-in-place and easily removable for maximum sample area access. Universal Ge crystal for analysis of all micro samples.
Sample Stage	Z focus including X, Y slide sample holder, with 20 x 50 mm travel
IR Collection/Sample Viewing	Dichroic Optics reflect IR energy and transmit visible, providing continuous view of the sample during data collection. Dichroic Optics eliminate the need to switch optics from view sample to collect spectrum.
Sample Masking	X, Y, θ variable glass aperture for transmission sampling to view sample and surrounding sample area. Standard pinhole aperture slide for reflection sampling.
Illumination	Köhler, variable intensity, 50 watt
Sample Viewing	Binocular or Trinocular Viewer with 10X eyepieces. Standard eyepiece reticule for sample dimensioning, optional video camera with USB interface.
Visible Field of View	1600 microns
Visible Image Contrast	Better than 1 micron
Station	In sample compartment, fits most FTIR spectrometers. Mounted on a baseplate for the FTIR spectrometer.
Detector	Uses standard detectors of the FTIR, typically DTGS and MCT
Purge	Includes purge tubes and purge inlet for additional purge. Compatible with sealed and desiccated FTIR spectrometers.
Regulatory	RoHS and CE Mark compliant

Please contact PIKE Technologies for additional product details.

ORDERING INFORMATION

Bundled μ MAX Packages

PART NUMBER	DESCRIPTION
034-21XX	Complete μ MAX Sample Compartment IR Microscope with transmission, reflection, Ge ATR and video camera
034-22XX	μ MAX Sample Compartment IR Microscope with transmission, reflection and Ge ATR
034-41XX	Complete μ MAX Sample Compartment IR Microscope for reflection, Ge ATR and video camera
034-42XX	μ MAX Sample Compartment IR Microscope with reflection and Ge ATR

Notes: Replace **XX** with your spectrometer's Instrument Code. [Click for List >](#)
All bundled μ MAX packages include trinocular viewer, slide aperture for reflection, X, Y sample stage, microsampling kit, spectrometer base mount, purge tubes and storage case. Transmission versions include X, Y, θ variable see-through aperture.

Configurable μ MAX Systems μ MAX BASE OPTICS

PART NUMBER	DESCRIPTION
034-20XX	μ MAX Sample Compartment IR Microscope for transmission and reflection (ATR optional)
034-40XX	μ MAX Sample Compartment IR Microscope for reflection (ATR optional)

Notes: Replace **XX** with your spectrometer's Instrument Code. [Click for List >](#)
The μ MAX Sample Compartment IR Microscope is available in versions for transmission and reflection sampling or reflection only – both versions are also compatible with ATR sampling. RotATR μ MAX ATR must be purchased separately. Both versions include slide aperture for reflection, X, Y sample stage, microsampling kit, spectrometer base mount, purge tubes, and storage case. Transmission version includes X, Y, θ variable see-through aperture.

SAMPLE VIEWING OPTIONS (must select one or more)

PART NUMBER	DESCRIPTION
034-3020	Binocular Viewer for μ MAX
034-3030	Trinocular Viewer for μ MAX
034-3010	Video Camera for μ MAX

Notes: Trinocular Viewer is required for selection of the Video Camera option. Binocular and Trinocular Viewers include adjustable reticule to assist with sample dimensioning.

MICRO ATR (optional)

PART NUMBER	DESCRIPTION
034-3040	RotATR, μ MAX ATR, Ge Crystal

Note: The RotATR micro ATR is compatible with the μ MAX Sample Compartment IR Microscope.

Sampling Options, Upgrades and Replacement Parts

MICROSAMPLING OPTIONS

PART NUMBER	DESCRIPTION
034-3060	Micro Compression Cell for 13-mm IR transparent windows
160-1135	Window, KBr, 13 mm x 2 mm
162-0030	Micro Plane, carbide blade
162-0040	Micro Plane, diamond blade
162-0010	Micro Diamond Cell, 1.6 mm
162-0020	Micro Diamond Cell, 2.0 mm
162-0045	Micro TouchPick Pen Set <i>Includes pen with tip size 0.62mm, pen with tip size 0.17mm, scalpel/roller knife, cleaning compound and holder case</i>
162-0046	Diamond Window, 2.5 mm
162-0047	Diamond Window, 3.5 mm
162-0048	Micro Vice-Mini
034-0923	Micro Roller Knife

Note: For additional product information, see the microsampling tools section.

 μ MAX IR MICROSCOPE UPGRADES

PART NUMBER	DESCRIPTION
034-0090	μ MAX IR Microscope Transmission Upgrade

Notes: Transmission Upgrade requires shipment of the accessory to PIKE Technologies. Upgrade includes μ MAX condenser, X, Y, θ variable see-through aperture, and all additional optics required for transmission, reflection and optional ATR sampling.

 μ MAX IR MICROSCOPE REPLACEMENT PARTS

PART NUMBER	DESCRIPTION
300-0025	Gold-Surfaced Disk, 13 mm, for reflection analysis
034-3070	IR Microsampling Kit <i>Includes 3-position sample slide with gold mirror, 2 KBr windows, scissors, tweezers, probes and roller knife with replacement blades</i>
162-6401	3-position Sample Slide for 13-mm windows
300-0002	Gold-Surfaced Sample Slide
034-3080	Replacement Illumination Bulb for μ MAX

Note: For options not listed here, please contact PIKE Technologies.

Microsampling Tools – Compression Cells and Sample Manipulation

Micro Compression Cell

An excellent sampling tool for supporting small samples for transmission analysis with the PIKE μ MAX IR microscope. Single crystals, flattened fibers, multi-layer polymer micro samples are firmly supported between salt windows – typically KBr for transmission analysis. The cell uses 13 x 2 mm windows and has a clear aperture of 10 mm. Compression of the sample is achieved by rotation of the knurled retainer.



Diamond Window

Offers a durable, multi-use window for microscopic transmission measurements spanning from the UV to the far-IR regions. Two diamond sizes are available, 2.5 and 3.5 mm and are secured in a 13-mm diameter housing which may be used with the 3-Position Sample Slide (sold separately). The diamond is Type IIa.



Micro Plane with either Carbide or Diamond Blade

A useful tool for preparation of thin slices of multi-layered samples for transmission microanalysis. The Micro Plane is available with either carbide or diamond blade. The carbide blade is recommended for general polymer materials. The diamond blade is recommended when the multi-layered sample has metallic content. The Micro Plane features an adjustable knife edge to control sample thickness.



3-Position Sample Slide

The PIKE 3-Position Sample Slide is designed for placement of 13-mm windows for transmission analysis or the 13-mm gold-surfaced disk for reflection analysis when using the μ MAX IR Microscope. An open port of the 3-Position Sample Slide is used conveniently to support a flattened free-standing fiber for transmission analysis.



Micro TouchPick Pen Set

Ideal for the delicate maneuvering of your specimens. The benefits are excellent control of sample handling, ease of handling fragile and statically charged samples, and no residue is left on the sample. The ergonomic pen set includes two pens with different sized adhesive tips (0.17 and 0.62 mm).



Micro Vice-Mini

A multi-use sample holder fitting most microscope stages including IR, Raman and light microscopes. It makes holding round and unevenly-shaped samples easy. It may tilt the sample for correcting oblique sample orientation, and may be used to stretch fibers and polymer films.

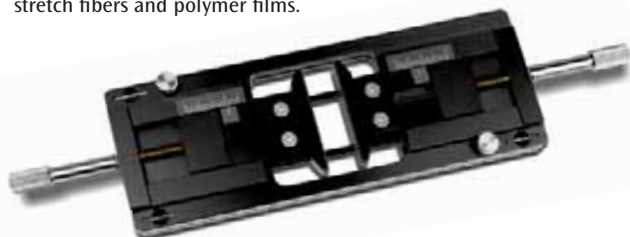

ORDERING INFORMATION

MICROSAMPLING TOOLS

PART NUMBER	DESCRIPTION
034-3060	Micro Compression Cell <i>(requires selection of two 13 x 2 mm windows)</i>
160-1135	Window, KBr, 13 x 2 mm (1 ea.)
160-1008	Windows, KBr, 13 x 2 mm (6 pack)
162-0030	Micro Plane, carbide blade
162-0040	Micro Plane, diamond blade
162-0045	Micro TouchPick Pen Set <i>Includes pen with tip size 0.62 mm, pen with tip size 0.17 mm.</i>
162-0048	Micro Vice-Mini
162-0046	Diamond Window, 2.5 mm aperture
162-0047	Diamond Window, 3.5 mm aperture
162-6401	3-Position Sample Slide <i>(recommended selection of window or disk)</i>
300-0025	Gold-Surfaced Mirror, 13 x 2 mm
034-3070	IR Microsampling Kit <i>Includes 3-position sample slide with gold mirror, 2 KBr windows, scissors, tweezers, probes and roller knife with replacement blades</i>
034-0923	Micro Roller Knife

Note: For items not in this list please contact PIKE Technologies.
For other 13 x 2 mm windows available, see the Transmission section.

Micro Diamond Cell – For Compressing and Holding Samples for Microanalysis



FEATURES

- Compression and positioning for micro samples
- 1.6-or 2.0-mm clear aperture versions
- Easy thumb wheel mechanism for application of pressure
- Compatible with UV to far-IR spectral regions
- Compatible with PIKE μ MAX IR microscope and beam condensers
- 14,000 psi pressure (10 kgf/mm²)

Small samples are easily held in place and flattened to ideal thicknesses for FTIR analysis using the PIKE Technologies Micro Diamond Cell. The diamond windows in this cell are Type IIa synthetic for excellent transmission from the UV through far-IR spectral regions. The hardness of diamond enables maximum pressure to be applied to all types of crystalline, fiber, or amorphous materials. Typical samples include fibers, paint chips, rubbers, and plastic materials including laminates.

The large clear aperture of the PIKE Technologies Micro Diamond Cell (either 1.6 or 2.0 mm) makes it easy to place the micro sample into position while viewing under a stereomicroscope. The large thumb wheels provide easy means of tightening and flattening the samples.

The PIKE Technologies Micro Diamond Cell is mounted on a standard 2" x 3" plate compatible with your FTIR spectrometer sample compartment. However, it performs best with a beam condenser or IR microscope. Cell thickness is 9.3 mm fully assembled.

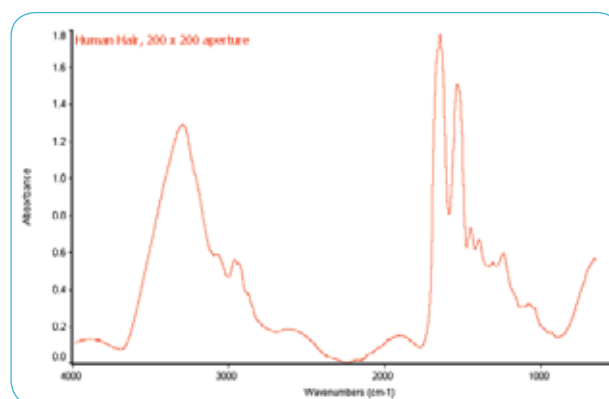

Human hair sample flattened in the PIKE Micro Diamond Cell and analyzed using the μ MAX IR microscope.

ORDERING INFORMATION

PART NUMBER DESCRIPTION

162-0010 Micro Diamond Cell, 1.6 mm

162-0020 Micro Diamond Cell, 2.0 mm

Notes: The Micro Diamond Cell is easily placed onto the X, Y stage of the PIKE μ MAX IR microscope. Mounting the Micro Diamond Cell into the PIKE beam condensers requires the optional slide holder.

Compact Transmission/Reflection S-100R Microscope Heat Stage – High-Temp Measurements under Vacuum or Controlled Gas Flow



FEATURES

- Compact design fits most stages of FTIR and Raman microscopes
- Direct transmission measurements in sample compartments of FTIR spectrometers
- Precise temperature control up to 600 °C
- Vacuum, reaction gas or inert gas chamber environment
- Easy sample loading, assembly and disassembly

The S-100R Microscope Heat Stage is designed for spectroscopic analysis and monitoring of small samples at varying temperatures. The accessory can be located directly on the sampling stages of most FTIR and Raman microscopes. It can also be used for transmission measurements when placed in the sample compartment of the spectrometer.

SPECIFICATIONS

Stage Body	Aluminum
Aperture	Maximum: 4 mm, Minimum: 1 mm
Chamber Window	20 mm x 2 mm
Sample Port Window	13 mm x 1 mm
Leak Rate	$< 1 \times 10^{-9}$ Pa m ³ /sec
Vacuum Achievable	1×10^{-3} Torr
Pressure Maximum	0.5 MPa (requires BaF ₂ , CaF ₂ , ZnSe, SiO ₂ windows)
Gas Connection	1/16" Swagelok®
Coolant Connection	4-mm quick connection (optional)
Stage Dimensions (W x D x H)	84 x 100 x 16 mm
Stage Weight	0.5 kg
Temperature Control	Resistive heating
Temperature Range	Ambient to 600 °C
Accuracy	+/- 0.5%
Sensor Type	Type K thermocouple
Temperature Controllers	
Digital	+/- 0.5% of set point
Digital PC	+/- 0.5% of set point, graphical setup, up to 20 ramps, USB interface
Input Voltage	115/230 VAC, user-selectable
Output Voltage	115 VAC/80 W max.
Controller Dimensions (W x D x H)	130 x 230 x 210 mm

The stage features a lightweight aluminum body that is 16-mm thick. The sample is located between two IR transparent windows (transmission measurements) or between the IR reflecting mirror and single window (trans-reflection configuration). Samples can be easily loaded and removed by twisting the upper window plate by hand. Optional inserts for varying sample sizes and shapes are available and a wide selection of window materials can be used with the stage.

The accessory can be used under ambient conditions or under vacuum. Pressure up to 0.5 MPa is possible with appropriate windows. In addition, inert or reaction gas can be flowed through the stage chamber. Valves and connectors required for these special configurations should be ordered separately.

Temperature range of the S-100R Microscope Heat Stage spans from ambient to 600 °C, and is controlled with +/- 0.5% accuracy by digital controllers available in PC or dedicated configurations. PC option provides graphical parameter setup, ramping and USB connectivity. Liquid cooling is integrated into the accessory base in order to minimize heat transfer to the microscope stage, improve temperature stability and aid the cooling process.

ORDERING INFORMATION

PART NUMBER	DESCRIPTION
162-4186	S-100R Microscope Heat Stage <i>Includes holders for 1, 2, and 3-mm samples, coolant tube and 13 x 1-mm reference mirror</i>

TEMPERATURE CONTROLLERS (must select one)

PART NUMBER	DESCRIPTION
076-2460	S-100R Digital Temperature Controller, PC Control
076-2260	S-100R Digital Temperature Controller

WINDOWS (must select)

(1) 20 x 2 mm and (1) 13 x 1 mm for reflection measurement
(2) 20 x 2 mm and (1) 13 x 1 mm for transmission measurement

PART NUMBER	DESCRIPTION
160-1134	Disk, KBr, 20 x 2 mm
160-1148	Disk, BaF ₂ , 20 x 2 mm
160-1144	Disk, CaF ₂ , 20 x 2 mm
160-5003	Disk, KBr, 13 x 1 mm, max temp 300 °C
160-1149	Disk, BaF ₂ , 13 x 1 mm, max temp 500 °C
160-5001	Disk, CaF ₂ , 13 x 1 mm, max temp 900 °C

Note: Maximum temperature restriction applies to sample window. The temperature of the outer windows is significantly less due to required liquid recirculated water flow.

OPTIONS AND REPLACEMENT PARTS

PART NUMBER	DESCRIPTION
162-4114	Plate for Motorized Microscope Stage*
162-4115	Slide Mount for transmission measurements, 2" x 3"
162-4116	Holder for 1, 2, 3-mm diameter samples
162-4109	Gas Valve, 1/16" (gas connection) – 2 needed
162-4110	Quick Connector for external circulating liquid – 2 needed
162-4111	Reference Mirror, 13 x 1 mm
170-1100	Liquid Recirculator

*Must provide information for microscope make and model

Beam Condensers – 4X and 6X Versions for FTIR

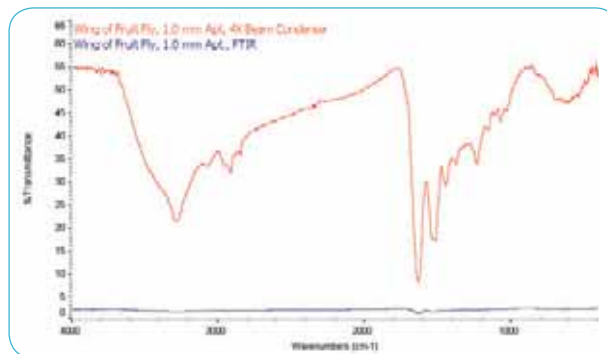

Wing of fruit fly within 1-mm aperture with and without use of a beam condenser.

FEATURES

- 4X and 6X versions – providing improved spectral data for microsampling
- High optical throughput – beam condensing optics provide higher signal-to-noise ratio for small samples
- Standard pin mounting for sample holders – providing a precise, reproducible mount for samples
- Standard sample holder block and alignment pinhole (1.5 mm)
- A variety of optional sample holders
- Enclosed accessory for complete purging

Basic beam condenser products have been available for many years. The PIKE Technologies Beam Condenser Accessories provide all the functionality of these basic systems with exceptional optical design and easy access to the sampling area. The unique enclosed optics provide a purged environment.

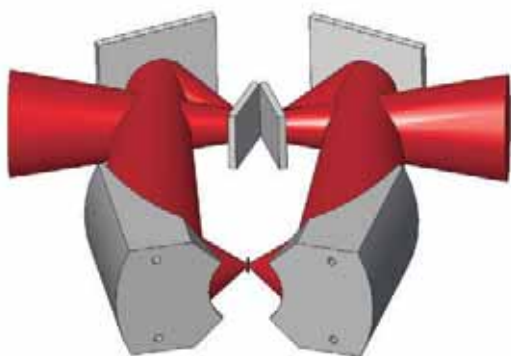

Beam Condenser optical diagram

Beam condensers offer easy transmission sampling with minimal sample preparation. The PIKE Technologies beam condensers are available in 4 and 6 times beam demagnification. The system design incorporates a layout of six mirrors, adjustable input and output mirrors and two matched 4:1 (or 6:1) ellipsoidal mirrors. Both provide a large working area to accept many types of transmission sampling accessories, including high-pressure diamond cells, liquid cells, mull cells, and micro holders. The sample area uses pins to ensure accurate and reproducible accessory alignment requiring no further adjustment. Either 4X or 6X beam condensers are available in standard or gold-coated optics for high-performance mid-IR or near-IR operation.

For the most demanding applications, a precision X, Y, Z Sampling Stage is available as an option, which accommodates all sampling accessories to achieve the highest possible optical throughput and allows a point-by-point surveying of an extended sample.



X, Y, Z Adjustable
Sample Position

Sample Holders for the PIKE Beam Condensers

A range of sample holders are available for making sample positioning easier. These may be mounted on the X, Y, Z stage for precision positioning or on the standard mount.

Universal Spring Sample Holder

– Ideal for small spheres and gems



Magnetic Sample Holder

– Ideal for 1 or 3-mm pellet die



Micro KBr Pellet and Mull Holder

– Ideal for very small volume solids, liquids and paste samples (holds 13-mm windows)



SPECIFICATIONS

Optics	All reflective, aluminum (standard) Gold-coated (optional)
Configurations	4X and 6X demagnifications
Sampling Options	Standard sample holders, X, Y, Z adjustable stage, Pressure diamond cells and micro holders
Purgeable	Yes
Dimensions (W x D x H)	165 x 242 x 114 mm (4X) 165 x 318 x 114 mm (6X)
FTIR Compatibility	Most, specify model and type

ORDERING INFORMATION

4X AND 6X BEAM CONDENSERS

PART NUMBER	DESCRIPTION
031-40XX	4X Beam Condenser <i>Includes the Non-Adjustable Sample Position Stage, 1.5 mm alignment aperture, purge tubes and mount for the FTIR of your selection</i>
031-60XX	6X Beam Condenser <i>Includes the Non-Adjustable Sample Position Stage, 1.5 mm alignment aperture, purge tubes and mount for the FTIR of your selection</i>

Notes: Replace XX with your spectrometer's Instrument Code. [Click for List >](#)
Contact PIKE Technologies for gold-coated mirror option.

ADJUSTABLE SAMPLE POSITION (optional)

PART NUMBER	DESCRIPTION
031-2010	X, Y, Z Adjustable Sample Position Stage

Note: The X, Y, Z Adjustable Sample Position Stage can be easily exchanged with the Non-Adjustable Sample Position Stage.

SAMPLE HOLDERS (optional)

PART NUMBER	DESCRIPTION
031-2030	Universal Spring Sample Holder
031-2040	Magnetic Sample Holder
031-2050	Micro KBr Pellet and Mull Holder

Note: All of these sample holders fit to the pin position of either the Non-Adjustable Sample Position Stage or the X, Y, Z Adjustable Sample Position Stage.

MICRO DIAMOND CELL (optional)

PART NUMBER	DESCRIPTION
162-0010	Micro Diamond Cell, 1.6 mm
162-0020	Micro Diamond Cell, 2.0 mm
031-2070	Mounting Stage for Micro Diamond Cell

Notes: Micro Diamond Cell includes anvil pressure cell assembly and Type IIa diamonds. Stage for Micro Diamond Cell is required for use with beam condenser.

BEAM CONDENSER REPLACEMENT PARTS

PART NUMBER	DESCRIPTION
031-2020	Non-Adjustable Sample Position Stage

Note: For options not listed here, please contact PIKE Technologies.

TRANSMISSION

Transmission sampling is a popular method for the collection of infrared spectra for qualitative or quantitative analysis. Samples range from solids to liquids and gases. Applying automation technologies to transmission sampling can improve precision and workflow efficiency.

Automated Vertical Accessories Page 92
Multi-SamplIR™ and RotatIR™

Automated Horizontal Multi-Sample System Page 94
High capacity sampling

XY Autosampler Page 95
For high-throughput microplate format sampling

YZ Autosampler Page 96
Automated transmission mapping stage

Liquid Cells Page 97
For comprehensive sampling of liquids

Heated Solid Transmission Accessory Page 104
For measurements of optical components and polymer

Dies, Presses, Grinders Page 105
For complete solids preparation

Holders, Windows, Polishing Kit Page 113
For optimizing transmission sampling

Gas Cells Page 118
*Short-Path, Long-Path and Heated
For comprehensive gas sampling*

**THEORY AND
APPLICATIONS**
Page 126

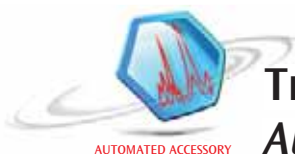

Transmission Multi-SamplIR – Automated In-Sample Compartment Accessory



FEATURES

- In-compartment automated transmission sampling
- Selectable number of samples, size, configuration and placement
- Multiple point analysis on single sample
- Custom sampling plates
- Fully automated and manual versions available

The PIKE Technologies Transmission Multi-SamplIR accessory is designed to speed FTIR analysis. The accessory accommodates up to 18 samples (depending on sampling plate configuration) for unattended analysis. Flexible test sequences are easily defined and automatically implemented. This Multi-SamplIR is ideal for analyzing a wide range of materials including films, slides, pellets, windows and large area samples like multilayer coated substrates.

Samples are conveniently mounted onto a sampling plate and held in place during the analysis. The plates can be configured for different sample quantities, types and geometries. The system can be set to perform automated mapping of the sample, producing transmission spectra as a function of position. Sampling plates are easily mounted on the support ring with spring-loaded clips, ensuring that the plate remains precisely located and correctly registered. The support ring mounts on the accessory's drive and is rotated and translated laterally through a distance of 75 mm to produce an R-theta motion covering the entire sampling range of the accessory.

Each system incorporates two precision stepper motors for rotation and translation of the plate. The motors are driven by the PIKE Motion Control Unit.

The operation is managed by PIKE Technologies' AutoPRO software, which provides full user programmability and an easy-to-learn "point-and-click" environment. Polar or X, Y coordinates may be used to define test points. AutoPRO software allows complex test sequences to be set up, stored as methods and implemented with full flexibility. Spectral data collection of pre-defined positions may be initiated through AutoPRO when using most FTIR spectrometers. The USB Motion Control Unit incorporates a smart power supply and works with 85–265 VAC, 47–63 Hz power lines.

The Transmission Multi-SamplIR accessory is designed to fit most FTIR spectrometers. Please contact us for more product details.

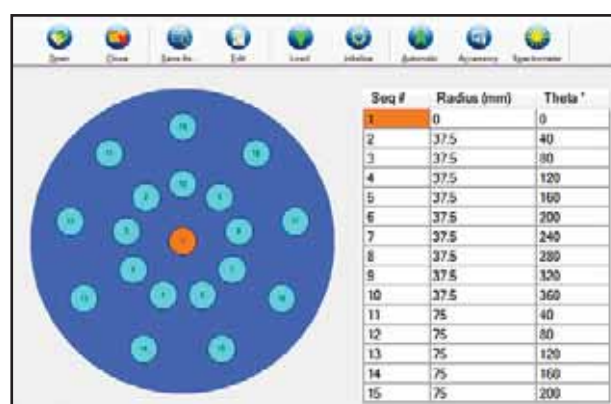

AutoPRO software configured for the Transmission Multi-SamplIR.

ORDERING INFORMATION

PART NUMBER DESCRIPTION

074-26XX Automated Transmission Multi-SamplIR for FTIR
Includes AutoPRO software and a motion control unit
(85–265 VAC), and a Standard Sampling Plate for 13-mm
pellets (18 positions)

Notes: Replace XX with your spectrometer's Instrument Code. [Click for List >](#)
This accessory requires a minimum FTIR beam height of 3.5".

OPTIONS

PART NUMBER DESCRIPTION

074-3661 Additional Standard Sampling Plate

Note: If you need custom sampling plates or options not described here, please contact us.



RotatIR – Automated Rotating Sample Stage



FEATURES

- Automated selection of sample transmission angle
- Programmable from 0 to 360 degrees with resolution of 0.2 degree
- Automated collection of spectra at the defined angle of transmission via AutoPRO software
- Compatible with most FTIR systems

The PIKE Technologies RotatIR is designed for automated selection of the sample transmission angle relative to the IR beam in the FTIR sample compartment. Applications include the study of sample thickness and sample reflectivity. Selection of the angle of transmission is automated through the use of PIKE Technologies AutoPRO software, the Motor Control Unit and the integrated stepper motor. Spectral data collection of pre-defined angles may be initiated through AutoPRO when using most FTIR spectrometers. The RotatIR features a standard 2 x 3" slide mount for easy positioning of different types of transmission sample holders. The PIKE RotatIR accessory is designed to fit most FTIR spectrometers. Please contact us for more product details.



Film sampling cards for the RotatIR accessory.

AutoPRO software allows complex test sequences to be setup, stored as methods and implemented with full flexibility. The USB Motion Control Unit incorporates a smart power supply and works with 85–265 VAC, 47–63 Hz power lines.

The Dual RotatIR is designed for the transmission measurements of thicker optics. As the beam passes through an optic placed at an angle, the refractive index of the optic will cause the beam to refract and as a result of this beam displacement only part of the beam could striking the spectrometer detector. By placing two testing optics at equal angle, the first optic will displace the beam and the second optic returns it to a position which may be effectively focused on the FTIR detector.



Dual RotatIR

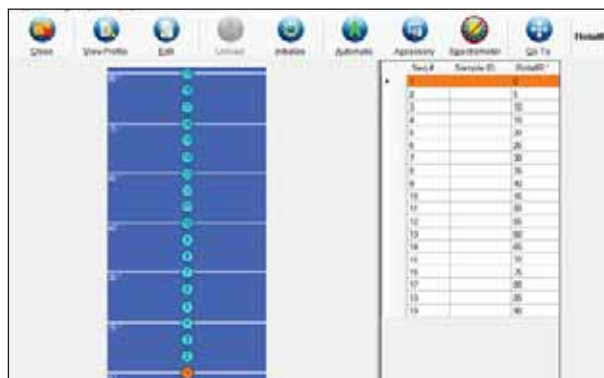

AutoPRO software for programming pre-defined angles.

ORDERING INFORMATION

PART NUMBER	DESCRIPTION
091-20XX	RotatIR Automated Rotating Sample Stage Includes AutoPRO software and a Motion Control Unit (85–265 VAC)
091-21XX	RotatIR with Polarizer Mount
091-22XX	Dual RotatIR

Note: Replace XX with your spectrometer's Instrument Code. [Click for List >](#)

OPTIONS

PART NUMBER	DESCRIPTION
162-5400	Film Sampling Card, 20-mm clear aperture (10 ea.)

Note: If you need options not described here, please contact us.



Automated Horizontal Transmission Accessory – For Films or Pellets



FEATURES

- Fully automated transmission analysis of polymer films, pellets or other transmission samples for FTIR
- Standard specular reflectance sampling
- Sampling capacity of up to 114 samples, depending upon size
- Continuous operation with multiple plates
- Purgeable optical design for high-quality FTIR spectra

PIKE Technologies offers the Automated Horizontal Transmission Accessory for increasing sample throughput for analysis of films and pellet samples.

The Automated Horizontal Transmission Accessory is available in an 8" or a 12" version depending upon sample loading requirements. The 8" version will accommodate up to 37 25-mm diameter samples. The 12" version will accommodate up to 83 25-mm diameter samples. PIKE Technologies manufactures custom sampling plates to meet your exact sampling needs. Please contact us for other configurations.

Both the 8" and 12" versions are capable of performing specular reflection analysis as well as transmission analysis, if required for your application.

The operation is managed by PIKE Technologies' AutoPRO software, which provides full user programmability and an easy-to-learn "point-and-click" environment. AutoPRO software allows complex test sequences to be set up, stored as methods and implemented with full flexibility. Data collection of pre-defined positions may be initiated through AutoPRO when using most FTIR spectrometers. The Motion Control Unit incorporates a smart power supply and works with 85–265 VAC, 47–63 Hz power lines.

The Automated Horizontal Transmission Accessory is compatible with most FTIR spectrometers.

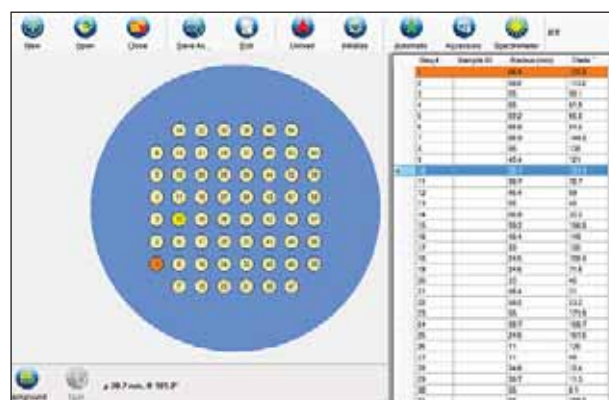

The PIKE Autosamplers are controlled by AutoPRO software, with a point-and-click user environment to define sampling positions.

ORDERING INFORMATION

PART NUMBER	DESCRIPTION
075-28XX	Automated 8" Horizontal Transmission Accessory Includes motion control unit (85–265 VAC), AutoPRO software and one 37-position sampling plate
075-29XX	Purge-Ready Automated 8" Horizontal Transmission Accy Includes motion control unit (85–265 VAC), AutoPRO software and one 37-position sampling plate (order Purge Enclosure separately)
076-28XX	Automated 12" Horizontal Transmission Accessory Includes motion control unit (85–265 VAC), AutoPRO software and one 83-position sampling plate

Notes: Replace **XX** with your spectrometer's Instrument Code. [Click for List >](#)
P/N 076-28XX is purge-ready; order purge enclosure separately.

OPTIONS

PART NUMBER	DESCRIPTION
075-3881	Additional Sampling Plate for 8" Automated Horizontal Transmission Accessory
076-3881	Additional Sampling Plate for 12" Automated Horizontal Transmission Accessory
016-3000	Purge Enclosure for 8" Horizontal Transmission Accessory
017-3000	Purge Enclosure for 12" Horizontal Transmission Accessory

Notes: **Purge enclosures will not fit all spectrometer models.** For more options or custom plates, please contact PIKE Technologies.



XY Autosampler – Transmission and Reflection, Automated Sampling in Microplate Format



FEATURES

- Complete hardware and software package for automated analysis with standard 24-, 48-, or 96-well plates. Special plate configurations available
- Diffuse reflectance of powdered samples or specular reflectance sampling for reaction residues
- Gold-coated optics version for highest performance mid-IR and near-IR sampling
- Optional transmission sampling with integrated DTGS or InGaAs detector
- Fully enclosed, purgeable design with CD-style loading tray
- In-compartment mounting, compatible with most FTIR spectrometers

The PIKE Technologies XY Autosampler is designed around standard 24-, 48- or 96-well microplate architectures – ideal for high-efficiency sample loading and FTIR analysis. The loading tray moves to a position outside of the accessory for easy loading and unloading of samples while conserving the purge. This also permits interface to a robot/autoloader.

Applications include high throughput analysis of liquid residues and chemical reactions, powdered samples, and automated diffuse reflection analysis. The XY Autosampler is available with standard all reflective aluminum optics or with gold-coated optical components for highest performance in mid-IR and optimized NIR sampling.

The optical design of the XY Autosampler is based upon a precision ellipsoidal reflector. The size of the spot illuminated at the sample is approximately 2 mm – ideal for up to 96-well configurations. The accessory is compatible with most FTIR spectrometers.

SPECIFICATIONS

Optics	Elliptical – 3X beam demagnification
Accuracy	+/- 25 μ m
Mechanical Specifications	
Repeatability	+/- 5 μ m
Resolution	1 μ m
Minimum Run Time	56 seconds for 96-well plate (actual time is spectrometer and application dependent)
Computer Interface	USB
Dimensions (W x D x H)	159 x 336 x 141 mm (including micrometer)
Weight	4.6 kg

A unique 96-well silicon plate is available for mid-IR sample analysis by transmission. For diffuse reflection measurements a dedicated plate is available featuring 96 polished cavities for placement of powder samples. Please contact us if you require specialized sampling plate configurations.

The XY Autosampler features an X, Y stage with both axes driven by high-precision servo motors with optical encoders for speed and reproducibility. USB and DC power are the only external connections required for this accessory. The transmission option requires a spectrometer external IR detector port.

Programming and control of the XY Autosampler is done through PIKE Technologies' AutoPRO software, which can be integrated easily with most FTIR software packages.

High-quality FTIR spectra of solvent residues collected with the XY Autosampler.

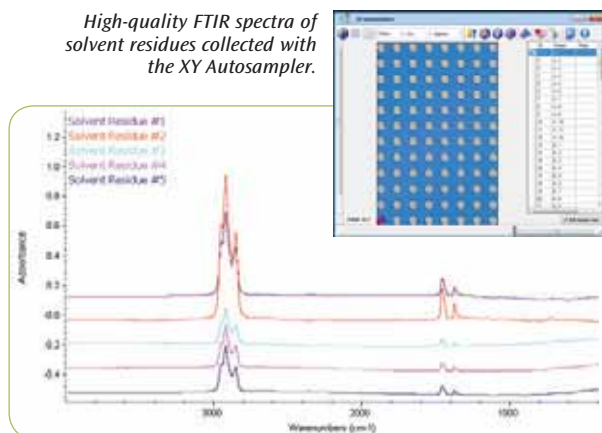

ORDERING INFORMATION

PART NUMBER	DESCRIPTION
047-22XX	XY Autosampler – Diffuse Reflectance/Transmission <i>Includes AutoPRO software, integrated DTGS detector, 96-well diffuse reflectance and 96-well transmission sampling plates</i>
047-62XX	XY Autosampler – Diffuse Reflectance/Transmission with Gold-Coated Optics <i>Includes AutoPRO software, integrated DTGS detector, 96-well diffuse reflectance and 96-well transmission sampling plates</i>
047-23XX	XY Autosampler – Diffuse Reflectance/Transmission <i>Includes AutoPRO software, integrated InGaAs detector, 96-well diffuse reflectance sampling plate</i>
047-63XX	XY Autosampler – Diffuse Reflectance/Transmission with Gold-Coated Optics <i>Includes AutoPRO software, integrated InGaAs detector, 96-well diffuse reflectance sampling plate</i>

Notes: Replace XX with your spectrometer's Instrument Code. [Click for List >](#)
For transmission option your spectrometer must be capable of interfacing with an external detector. A glass-bottom well plate is recommended for NIR transmission measurements. For diffuse-only options of this accessory, please see the Diffuse Reflectance section.

OPTIONS

PART NUMBER	DESCRIPTION
073-9110	96-Well Diffuse Reflectance Sampling Plate
073-9130	96-Well Si Transmission Sampling Plate



YZ Autosampler – Automated Transmission Mapping Stage

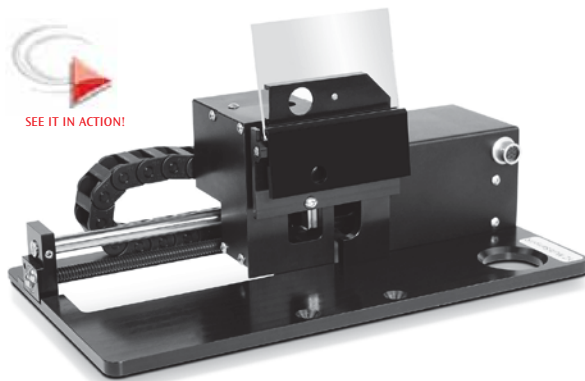

FEATURES

- Mapping in the horizontal and vertical plane
- Preferred directional mapping for orientation sensitive samples
- Automated position control through AutoPRO software
- Fits within the sample compartment of most FTNIR/FTIR instruments

PIKE Technologies introduces the new YZ Autosampler. This accessory is designed for transmission measurements where precise mapping is required. With its Y and Z plane movement (no rotation), it is an ideal accessory for samples that have a spectral signature influenced by orientation such as a polarizing film. Typical samples analyzed in the YZ Autosampler include coatings on glass and polymer films.

The YZ Autosampler features a translating Y, Z stage with both axes driven by high-precision servo motors with optical encoders for speed and reproducibility. Its sample holder clip allows samples to be easily and reproducibly positioned. The sample aperture is 4 x 3 mm. To reduce the aperture size, there is an integrating mask slot to fit a standard 1 x 3 mm aperture mask; inquire about custom aperture sizes.

SPECIFICATIONS

Measurement Technique	Transmission
Maximum Sample Size	100 mm horizontal, 25 mm vertical
Aperture Size	4 x 3 and 1 x 3 mm
Accuracy	+/- 25 μ m
Mechanical Specifications	
Repeatability	+/- 5 μ m
Resolution	1 μ m
Computer Interface	USB
Dimensions (W x D x H)	140 x 254 x 115 mm
Weight (excluding baseplate)	1.4 kg

USB and DC power are the only external connections required for this accessory. The YZ Autosampler fits most FTNIR/FTIR spectrometers. Please contact PIKE Technologies for mapping stages fitting research-grade UV-Vis spectrophotometer options.

Programming and control of the YZ Autosampler is done through PIKE Technologies' AutoPRO software. The versatility of AutoPRO allows for custom templates for various sample sizes and user prescribe data sampling points. AutoPRO integrates with most commercial FTIR spectrometers for automated spectral data collection, and is compatible with Windows 7 and Windows 10.

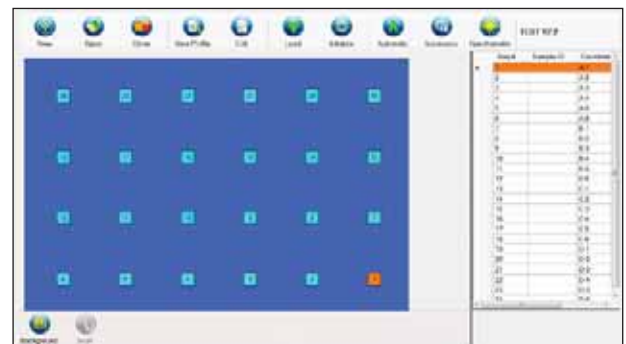

AutoPRO software configured for the YZ Autosampler

ORDERING INFORMATION

PART NUMBER DESCRIPTION

046-10XX YZ Autosampler

Notes Replace XX with your spectrometer's Instrument Code. [Click for List >](#)

Press-On Demountable Cell – For Viscous Liquids and Mulls



The PIKE Technologies Press-On Demountable Liquid Cell is recommended for fast and convenient qualitative analysis of viscous liquids and mull samples. Simply spot the sample onto the middle of the transparent IR window and slip the second window over the top. The windows are conveniently held in place by the friction fit of the Demountable Cell Holder. The Press-On Demountable Cell is available in 2 sizes – 25-mm and 32-mm diameter and has optional Teflon spacers to assist with sampling pathlength. A wide variety of window types and spacer pathlengths are available to cover NIR, mid-IR and far-IR spectral regions and sample composition from organic to aqueous.

The PIKE Technologies Press-On Demountable Liquid Cell is designed with a standard 2" x 3" plate for use with all FTIR spectrometers.

FEATURES

- Flexible window selection for optimizing spectral range and sample compatibility
- Demountable cell design for optimal cleaning of difficult samples
- Compatible with all FTIR spectrometers

ORDERING INFORMATION

PRESS-ON DEMOUNTABLE LIQUID CELL HOLDERS

PART NUMBER	DESCRIPTION
162-3600	Press-On Demountable Liquid Cell Holder for 25-mm Windows <i>Includes cell holder and O-ring</i>
162-3610	Press-On Demountable Liquid Cell Holder for 32-mm Windows <i>Includes cell holder and O-ring</i>

WINDOWS FOR PRESS-ON DEMOUNTABLE LIQUID CELL

(select minimum of 2)

PART NUMBER		DESCRIPTION
25 x 4 mm	32 x 3 mm	
160-1217	160-1147	BaF ₂
160-1211	160-1143	CaF ₂
160-1138	160-1137	Ge
160-1133	160-1132	KBr
160-1127	160-1126	KRS-5
160-1124	160-1122	NaCl
160-5214	160-5216	Polyethylene
160-1116	160-1159	Si
160-1114	160-1113	ZnSe

Notes: For window compatibility please consult the Materials Properties table on page 128 of this catalog. Find additional window selections starting on page 114.

SPACERS FOR PRESS-ON DEMOUNTABLE LIQUID CELL (Optional)

PART NUMBER		PATHLENGTH (mm)
25 mm	32 mm	
162-1110	162-1210	0.015
162-1120	162-1220	0.025
162-1130	162-1230	0.050
162-1140	162-1240	0.100
162-1150	162-1250	0.200
162-1160	162-1260	0.500
162-1170	162-1270	1.000
162-1190	162-1290	Assortment

Notes: Spacer pathlength packages above include 12 each of the spacers. The assortment package includes 2 each of the different pathlengths.

REPLACEMENT PARTS

PART NUMBER	DESCRIPTION
162-3621	Viton® Barrel O-Rings for 25-mm cell (12 ea.)
162-1330	Viton Barrel O-Rings for 32-mm cell (12 ea.)
162-3620	Teflon® O-Ring, 25 mm (12 ea.)
162-1320	Teflon O-Ring 32 mm (12 ea.)

Note: For more Press-On Demountable Liquid Cell options, please contact PIKE Technologies.

MULLING AGENTS

PART NUMBER	DESCRIPTION
161-0500	Nujol®
161-0510	Flourolube®

Demountable Liquid Cells – For Versatile Pathlength Liquid Sampling



FEATURES

- Flexible window selection for optimizing spectral range and sample compatibility
- Flexible pathlength to optimize sample absorbance
- Demountable cell design for optimal cleaning of difficult samples
- Compatible with all FTIR spectrometers
- Temperature control version available (see page 101)

ORDERING INFORMATION

DEMOUNTABLE LIQUID CELL HOLDERS

PART NUMBER	DESCRIPTION
162-1100	Demountable Liquid Cell Holder <i>Includes cell holder, gaskets and one complete set of spacers – select windows below</i>
162-1200	Demountable Liquid Cell Holder with O-ring Seal <i>Includes cell holder, gasket, perfluoroelastomer O-rings and one complete set of spacers – select windows below</i>

Notes: Requires selection of windows. Please select 2 syringes from the next column for filling the demountable liquid cell.

32 x 3 mm WINDOWS FOR DEMOUNTABLE LIQUID CELL (must select minimum of 1 Plain and 1 Drilled)

PART NUMBER		DESCRIPTION
PLAIN	DRILLED	
160-1147	160-1146	BaF ₂
160-1143	160-1142	CaF ₂
160-1137	160-1136	Ge
160-1132	160-1131	KBr
160-1126	160-1125	KRS-5
160-1122	160-1121	NaCl
160-5216	160-5215	Polyethylene
160-1159	160-1158	Si
160-1113	160-1112	ZnSe

Notes: Demountable Liquid Cell Holder with O-ring Seal (PN 162-1200) is recommended with polyethylene windows. For window compatibility please consult the Materials Properties table on page 128 of this catalog. Find additional window selections starting on page 114.

The PIKE Technologies Demountable Liquid Cell is ideal for qualitative and quantitative analysis of liquid samples where it is desirable to optimize the pathlength for varying samples. It is well suited for samples where it is useful to disassemble the cell for cleaning. A wide selection of window types and spacer pathlengths are available to cover mid-IR, NIR and far-IR spectral regions and sample composition from organic to aqueous.

The PIKE Technologies Demountable Liquid Cell is designed with a standard 2" x 3" plate for use with all FTIR spectrometers. The needle plate includes Luer-Lok™ fittings for easy syringe filling of the sample. The window size is 32 x 3 mm and the clear aperture of the cell is 13 mm.

An O-ring seal option of the demountable cell replaces the flat sealing gasket with two small O-rings to seal around the drilled window filling holes. This modified needle plate version is recommended for users with highly volatile, low surface tension samples and low pressure flow experiments.

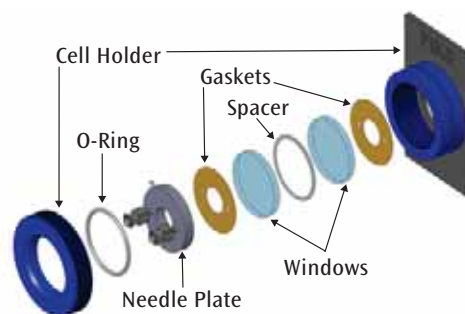

Demountable liquid cell assembly layout.

SPACERS FOR DEMOUNTABLE LIQUID CELL (optional)

PART NUMBER	PATHLENGTH (mm)
162-1210	0.015
162-1220	0.025
162-1230	0.050
162-1240	0.100
162-1250	0.200
162-1260	0.500
162-1270	1.000
162-1290	Assortment

Notes: Spacer pathlength packages above include 12 each of the spacers. The assortment package includes 2 each of the different pathlengths.

REPLACEMENT PARTS

PART NUMBER	DESCRIPTION
162-1104	Demountable Liquid Cell Needle Plate
162-1113	Demountable Alignment Caps (2 ea.)
162-1112	Nylon Leur Caps (2 ea.)
162-1300	Teflon Stoppers for Needle Plate (12 ea.)
162-1310	Teflon Gaskets (12 ea.)
162-1320	Teflon O-Rings (12 ea.)
161-0520	Glass Syringe, 1 mL
161-0521	Glass Syringe, 2 mL
161-0522	Glass Syringe, 5 mL

Note: For more options, please contact PIKE Technologies.

SmartSeal Liquid Transmission Cells – For Precision, Fixed Pathlength Liquid Sampling



The PIKE Technologies SmartSeal Liquid Cells are ideal for quantitative analysis of liquid samples, especially where precise, reproducible pathlength is required. Using a proprietary sealing technique, these are designed to be leak-proof for long-lasting sampling and cost efficiency. The cells are fully RoHS compliant.

Each cell is mounted on a 2" x 3" slide mount card compatible with all FTIR spectrometers and includes Luer-Lok™ fittings for easy syringe filling of the sample. The clear aperture of the assembled cell is 13 mm. SmartSeal Cells are available in a wide variety of window materials and sampling pathlengths.

FEATURES

- RoHS compliant
- Permanently mounted cell with fixed pathlength to provide maximum reproducibility of sample absorbance
- Flexible window selection for optimizing spectral range and sample compatibility
- Full range of cell pathlengths for optimized quantitative measurements
- Compatible with all FTIR spectrometers



ORDERING INFORMATION

SMARTSEAL LIQUID CELLS – WINDOW OPTIONS

Path (mm)	0.015	0.025	0.05	0.10	0.15	0.20	0.50	1.0	5.0	10.0
Volume (mL)	0.005	0.009	0.018	0.036	0.054	0.072	0.18	0.36	1.80	3.60
BaF ₂	165-4000	165-4001	165-4002	165-4003	165-4004	165-4005	165-4006	165-4007	165-4009	165-4010
CaF ₂	165-5000	165-5001	165-5002	165-5003	165-5004	165-5005	165-5006	165-5007	165-5009	165-5010
CsI	165-9000	165-9001	165-9002	165-9003	165-9004	165-9005	165-9006	165-9007	165-9009	165-9010
KBr	165-1000	165-1001	165-1002	165-1003	165-1004	165-1005	165-1006	165-1007	165-1009	165-1010
KRS-5	165-8000	165-8001	165-8002	165-8003	165-8004	165-8005	165-8006	165-8007	165-8009	165-8010
NaCl	165-2000	165-2001	165-2002	165-2003	165-2004	165-2005	165-2006	165-2007	165-2009	165-2010
SiO ₂	165-6000	165-6001	165-6002	165-6003	165-6004	165-6005	165-6006	165-6007	165-6009	165-6010
ZnSe	165-3000	165-3001	165-3002	165-3003	165-3004	165-3005	165-3006	165-3007	165-3009	165-3010
ZnS	165-7000	165-7001	165-7002	165-7003	165-7004	165-7005	165-7006	165-7007	165-7009	165-7010

Notes: Please select 2 syringes (below) for filling the SmartSeal Cell. All SmartSeal Cells include Teflon® stoppers. For more pathlength options please contact PIKE Technologies.

OPTIONS AND REPLACEMENT PARTS

PART NUMBER	DESCRIPTION
161-0520	Glass Syringe, 1 mL
161-0521	Glass Syringe, 2 mL
161-0522	Glass Syringe, 5 mL
162-1300	Teflon Stoppers (12 ea.)

Note: For other options please contact PIKE Technologies.

Long-Path Quartz Liquid Cells – For Analysis of Hydrocarbon Content and Related Measurements



FEATURES

- For the analysis of hydrocarbon content of water, soil and other environmental samples
- For analysis of polymer additives after extraction
- Highest quality quartz cells for clear infrared spectral transmission and optimized result

The PIKE Technologies Long-Path Quartz Liquid Cells are ideal for the quantitative analysis of hydrocarbons in water and soil samples or for the analysis of additive content in polymers after extraction. Sample extracts are easily transferred to the quartz cells for infrared analysis. Pathlengths ranging from 10 mm to 100 mm are available for optimization of the sample absorbance. The cells are manufactured of special grade IR quartz which is fully transparent in the hydrocarbon absorbance region. The quartz cells are compatible with organic and aqueous solvents and are suitable for use with the D7066-04 ASTM method. A 2" x 3" slide mount holder is available for the cells.

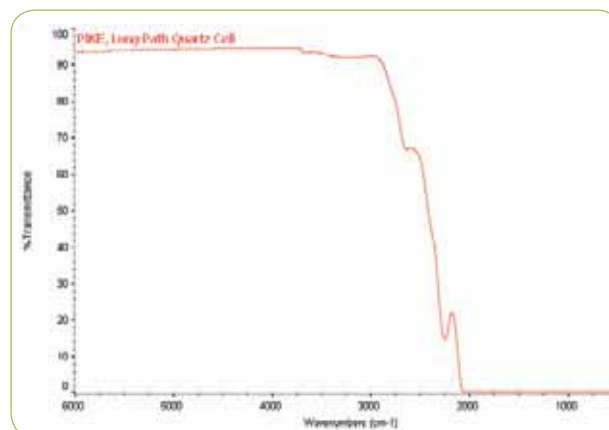

Spectrum of 10-mm Long-Path Quartz Cell.

SPECIFICATIONS

Cell Pathlength (mm)	Nominal Volume (mL)	Number of Stoppers
10	2.80	1
20	5.60	2
50	14.10	2
100	28.20	2

All cylindrical cells have an outside diameter of 22 mm and an inside diameter of 19 mm.

ORDERING INFORMATION

LONG-PATH QUARTZ LIQUID CELLS

PART NUMBER DESCRIPTION

162-1801	Long-Path Quartz Cell, 10 mm
162-1802	Long-Path Quartz Cell, 20 mm
162-1805	Long-Path Quartz Cell, 50 mm
162-1810	Long-Path Quartz Cell, 100 mm

Notes: Cells include Teflon stoppers. Select slide sample holder below.

HOLDERS FOR LONG-PATH QUARTZ LIQUID CELL

PART NUMBER DESCRIPTION

161-2530	Slide Sample Holder, Quartz Cell, 10–20 mm
161-2540	Slide Sample Holder, Quartz Cell, 50 mm
161-2550	Slide Sample Holder, Quartz Cell, 100 mm

Note: Please contact PIKE Technologies for replacement Teflon stoppers and items not described on this list.

Falcon Mid-IR Transmission Accessory – For Precise Temperature Control of Demountable Liquid Cells



PIKE TempPRO software for kinetic experiments.

FEATURES

- Peltier temperature control from 5 to 130 °C
- Wide selection of windows for optimizing spectral range and sample compatibility
- Flexible pathlength to control sample absorbance
- Demountable cell design for easy cleaning of difficult samples
- Available for most FTIR spectrometers

The PIKE Technologies Falcon Mid-IR Transmission Accessory is recommended for qualitative and quantitative analysis of liquids and protein solutions where it is necessary to control the temperature of the sample. Temperature range of the accessory is 5 to 130 °C with +/- 0.5% accuracy. Heating and cooling is controlled by a built-in Peltier device providing for reproducible ramping and for reaching target temperatures quickly and reliably. The system is driven by a digital temperature controller – directly or via PC.

A wide variety of window types and spacer pathlengths are available for this product. Window options cover NIR, mid-IR and far-IR spectral regions and sample compositions from organic to aqueous. A complete transmission cell for use with the Falcon Mid-IR Accessory consists of two 32 x 3 mm size windows (drilled and undrilled), an assorted spacer set, the needle plate with Luer-Lok fittings, two gaskets and a proprietary cell mount.

The full Falcon configuration requires the accessory base with cell holder, user selected windows, and one of the available temperature controllers. The Falcon accessory is compatible with most brands of FTIR spectrometers.



Liquid Recirculator

SPECIFICATIONS

Temperature Control	Peltier (cooling and heating)
Temperature Range	5 to 130 °C
Accuracy	+/- 0.5% of set point
Sensor Type	3 wire Pt RTD (low drift, high stability)
Temperature Controllers	
Digital	+/- 0.5% of set point
Digital PC	+/- 0.5% of set point, graphical setup, up to 100 ramps, USB interface
Input Voltage	90–264 V, auto setting, external power supply
Output Voltage	16 VDC/150 W max.
Dimensions (W x D x H)	89 x 121 x 83 mm (without FTIR baseplate and mount)

Notes: Peltier device must be water cooled for proper operation – this is achieved by running cold tap water through the water jacket integrated into the accessory shell, or by the use of an external liquid circulator.

ORDERING INFORMATION

PART NUMBER	DESCRIPTION
111-40XX	Falcon Mid-IR Base with Cell Holder <i>Includes temperature-controlled base, demountable cell, gaskets and one complete set of spacers. Select digital temperature controller (below) and windows (next page)</i>

Notes: Replace **XX** with your spectrometer's Instrument Code. [Click for List >](#)
Please select 2 syringes (next page) for filling the demountable liquid cell.

TEMPERATURE CONTROLLERS (must select one)

PART NUMBER	DESCRIPTION
076-1230	Digital Temperature Control Module for Falcon Accessory
076-1430	Digital Temperature Control Module, PC Control for Falcon Accessory

Notes: Digital Temperature Control Module is required to control temperature. PC version includes PIKE TempPRO software.

LIQUID RECIRCULATOR

PART NUMBER	DESCRIPTION
170-1100	Liquid Recirculator

ORDERING INFORMATION

**32 x 3 mm WINDOWS
FOR FALCON DEMOUNTABLE LIQUID CELLS***(must select minimum of 1 Plain and 1 Drilled)*

PART NUMBER		DESCRIPTION
PLAIN	DRILLED	
160-1147	160-1146	BaF ₂
160-1143	160-1142	CaF ₂
160-1137	160-1136	Ge
160-1132	160-1131	KBr
160-1126	160-1125	KRS-5
160-1122	160-1121	NaCl
160-1159	160-1158	Si
160-1113	160-1112	ZnSe

Notes: For window compatibility please consult the Materials Properties table on page 128 of this catalog. Find additional window selections starting on page 114.

DEMOUNTABLE LIQUID CELL SPACERS *(Optional)*

PART NUMBER	PATHLENGTH (mm)
162-1210	0.015
162-1220	0.025
162-1230	0.050
162-1240	0.100
162-1250	0.200
162-1260	0.500
162-1270	1.000
162-1290	Assortment

Notes: Spacer packages above include 12 spacers. The assortment package includes 2 each of the different pathlengths.

DEMOUNTABLE LIQUID CELL REPLACEMENT PARTS

PART NUMBER	DESCRIPTION
162-1600	Demountable Liquid Cell for the Falcon Mid-IR Accessory
162-1300	Teflon Stoppers (12 ea.)
162-1311	Viton Gasket, 32 mm (12 ea.)
162-1310	Teflon Gasket, 32 mm (12 ea.)
161-0520	Glass Syringe, 1 mL
161-0521	Glass Syringe, 2 mL
161-0522	Glass Syringe, 5 mL

Note: For other options for the Demountable Liquid Cell, please contact PIKE Technologies.

Falcon NIR Transmission Accessory – Quantitative and Qualitative Analysis of Liquids under Precise Temperature Control



FEATURES

- Fast, easy quantitative and qualitative analysis of samples under precise Peltier temperature control
- Choice of cuvette and vial adapters
- Compatible with disposable 5-, 8- and 12-mm vials
- Excellent thermal accuracy and precision
- Available for most FTIR spectrometers

The PIKE Technologies Falcon NIR Transmission Accessory is an excellent choice for quantitative and qualitative analysis of liquid samples in the NIR spectral region. Temperature range of the accessory is 5 to 130 °C with +/- 0.5% accuracy. Heating and cooling is controlled by a built-in Peltier device. The Peltier element provides for reproducible ramping and for reaching target temperatures quickly and reliably. The system is driven by a Digital Temperature Controller – directly or via PC.

Individual sample holders are designed to accommodate standard 5-mm, 8-mm and 12-mm glass vials and 1-cm cuvettes. Sample holders are pin-positioned to ensure maximum reproducibility.

The complete Falcon NIR configuration requires the accessory base, cell holder, and one of the available temperature controllers. The Falcon accessory is compatible with most brands of FTIR spectrometers.

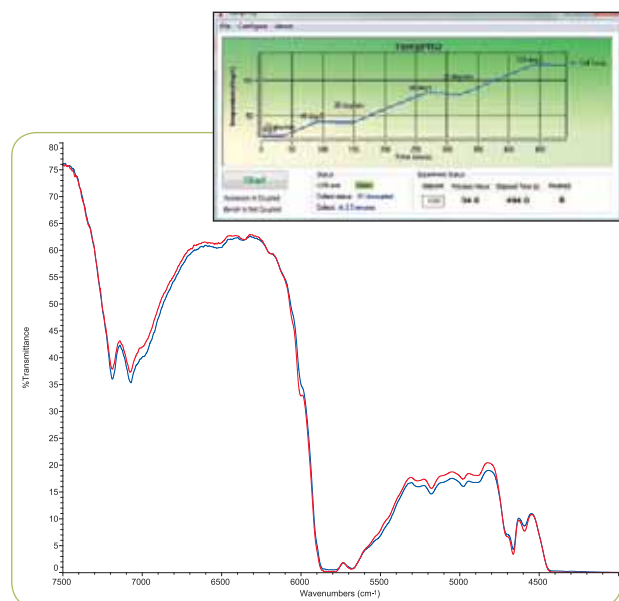

NIR transmission spectra of cooking oils in 8-mm glass vials measured at 32 °C with the Falcon NIR Transmission Accessory.

SPECIFICATIONS

Temperature Control	Peltier (cooling and heating)
Temperature Range	5 to 130 °C
Accuracy	+/- 0.5% of set point
Sensor Type	3 wire Pt RTD (low drift, high stability)
Temperature Controllers	
Digital	+/- 0.5% of set point
Digital PC	+/- 0.5% of set point, graphical setup, up to 100 ramps, USB interface
Input Voltage	90–264 V, auto setting, external power supply
Output Voltage	16 VDC/150 W max.
Dimensions (W x D x H)	89 x 121 x 83 mm (without FTIR baseplate and mount)

Notes: Peltier device must be water-cooled for proper operation – this is achieved by running cold tap water through the water jacket integrated into the accessory shell, or by the use of an external liquid circulator.

ORDERING INFORMATION

PART NUMBER DESCRIPTION

110-60XX	Falcon NIR Base <i>Includes temperature-controlled base. Digital Temperature Controller and sample holder need to be selected from the tables below for a complete system.</i>
----------	---

Note: Replace XX with your spectrometer's Instrument Code. [Click for List >](#)

TEMPERATURE CONTROLLERS (must select one)

PART NUMBER DESCRIPTION

076-1230	Digital Temperature Control Module for Falcon Accessory
076-1430	Digital Temperature Control Module, PC Control for Falcon Accessory

Notes: Digital Temperature Control Module is required to control temperature. PC version includes PIKE TempPRO software.

SAMPLE HOLDERS (must select one or more)

PART NUMBER DESCRIPTION

111-3610	Vial Holder, 5 mm
111-3620	Vial Holder, 8 mm
111-3630	Vial Holder, 12 mm
111-3640	Cuvette Holder, 1 cm

OPTIONS

PART NUMBER DESCRIPTION

162-0205	Glass Vials, 5 mm (200 ea.)
162-0208	Glass Vials, 8 mm (200 ea.)
162-0212	Glass Vials, 12 mm (200 ea.)
162-0255	Falcon Quartz Cuvette, 1 cm

Note: Please see more cuvette options on page 140.

LIQUID RECIRCULATOR

PART NUMBER DESCRIPTION

170-1100	Liquid Recirculator
----------	---------------------

Heated Solid Transmission Accessory – *Measurements of Optical Components and Polymers*



FEATURES

- Quick sample loading and unloading
- Selection of different size sample holders
- Wide temperature range – from ambient to 300 °C
- Environmentally enclosed configuration

The Heated Solid Transmission Accessory is designed to analyze solid samples at temperatures ranging from ambient to 300 °C. It supports a set of optional sample mounts able to hold samples from 12 mm to 30 mm in diameter and up to 3-mm thick. Sample loading is simple and does not require any tools. The accessory is equipped with a standard 2" x 3" slide that makes it easy to mount in all types of spectrometers and most spectrophotometers. The heating time from ambient temperature to 300 °C is 30 minutes.

Two models are available; standard and environmental. The environmental configuration features a sealed sample area. This creates an inert or reacting gas blanket around the sample making it an ideal accessory for glove box applications.

The temperature of the Heated Solid Transmission Accessory is regulated by a digital temperature controller. PC interfaced and free-standing versions are available. The accessory requires a liquid recirculator to prevent overheating.

SPECIFICATIONS

Cell Body	Aluminum
Mount	2" x 3" Slide Mount
Temperature Range	Ambient to 300 °C
Sample Thickness	3 mm max.
Dimensions (W x D x H)	77 x 51 x 93 mm
Cooling Requirements	
Coolant Temp	6 to 28 °C
Coolant Pressure	0.1–2 kgf/cm ²
Coolant Flow Rate	20–1000 mL/min
Temperature Controllers	
Digital	+/- 0.5% of set point
Digital PC	+/- 0.5% of set point, graphical setup, up to 100 ramps, USB interface
Input Voltage	90–264 auto-setting external power supply
Output Voltage	6A/24 VAC max.
Controller Dimensions (W x D x H)	140 x 200 x 60 mm

ORDERING INFORMATION

PART NUMBER	DESCRIPTION
112-1000	Heated Solid Transmission Accessory, standard
112-1100	Heated Solid Transmission Accessory, environmental

Note: Select at least one sample holder, which is specific to the configuration of the accessory – standard or environmental.

SAMPLE HOLDERS (must choose at least one)

PART NUMBER	DESCRIPTION
112-2010	12–15 mm Diameter Sample Holder, standard
112-2020	16–20 mm Diameter Sample Holder, standard
112-2030	21–25 mm Diameter Sample Holder, standard
112-2040	26–30 mm Diameter Sample Holder, standard
112-2110	12–15 mm Diameter Sample Holder, environmental
112-2120	16–20 mm Diameter Sample Holder, environmental
112-2130	21–25 mm Diameter Sample Holder, environmental

TEMPERATURE CONTROLLERS (must select one or more)

PART NUMBER	DESCRIPTION
076-1410	Temperature Controller, PC Control
076-1210	Temperature Controller

Note: PC version includes PIKE TempPRO software.

LIQUID RECIRCULATOR

PART NUMBER	DESCRIPTION
170-1100	Liquid Recirculator

25 x 2 mm WINDOWS

(must select two or more for environmental model only)

PART NUMBER	DESCRIPTION	PART NUMBER	DESCRIPTION
160-1306	BaF ₂	160-5086	SiO ₂
160-1212	CaF ₂	160-5122	SiO ₂ , Low OH
160-1305	KBr	160-1155	ZnSe
160-5213	Polyethylene		

Note: Find additional window selections starting on page 114.

Bolt Press & Hydraulic Die – Low-Cost Pellet Preparation



Bolt Press

Hydraulic Die

The PIKE Technologies Bolt Press and Hydraulic Die are low-cost tools for making KBr pellets for transmission FTIR analysis.

The press and die consist of a stainless steel barrel with two hardened and polished 13-mm rams. The barrels are equipped with a fitting which allows evacuation of air while the pellet is formed. For the Bolt Press, the pressure is applied to the sample by tightening the bolts against each other with standard 15/16" wrenches – included. For the Hydraulic Die the pressure is applied to the sample by placing it in a hydraulic press – up to 10,000 psi. Once a clear pellet is formed, the rams are removed and the sample is analyzed while still in the barrel (barrel is placed directly in the beam using the Press Holder with a standard 2" x 3" slide mount). Both accessories form a 13-mm pellet.

The PIKE Technologies Bolt Press and Hydraulic Die both include a holder.

ORDERING INFORMATION

PELLET PRESS

PART NUMBER	DESCRIPTION
161-2500	Bolt Press for 13-mm pellets
161-3500	Hydraulic Die for 13-mm pellets

Notes: The Bolt Press includes evacuable barrel, 2 anvil bolts, 2 15/16" wrenches, and Bolt Press Holder. The Hydraulic Die includes evacuable barrel, 2 rams and Hydraulic Die Holder. The maximum force limit 5 ton.

OPTIONS AND REPLACEMENT PARTS

PART NUMBER	DESCRIPTION
160-8010	KBr Powder, 100 g
161-5050	Agate Mortar and Pestle, 50 mm
161-2511	Wrench Set for Bolt Press (2 ea.)
161-2520	Holder for Bolt Press
161-2513	Barrel for Bolt Press
161-2525	Anvils for Bolt Press
161-3502	Anvils for Hydraulic Die

Note: For more pellet press options, please contact PIKE Technologies.

Hand Press – For Making Smaller Pellets



The PIKE Technologies Hand Press is an ideal solution for laboratories that require only occasional preparation of KBr pellets and cannot justify the expense of a hydraulic press.

The Hand Press is an efficient, reliable and inexpensive tool which simplifies making small pellets. It consists of a long stainless steel barrel and movable stage controlled by a lever capable of applying high pressure to the KBr/powder mixture. The Hand Press comes complete with three standard die sets (7, 3 and 1 mm). The pellet preparation involves loading of the powdered sample into the die chamber, placement of the upper anvil in the press and application of hand pressure to the lever (this is sufficient to provide clear, high-quality KBr disks). The Die Collar with the formed pellet is removed from the press and in most cases it can be placed directly in the beam of the spectrometer for analysis. The Hand Press is equipped with a platen position dial for adjustment of the force applied to the die for reproducible sample preparation.

ORDERING INFORMATION

PART NUMBER	DESCRIPTION
161-1100	Hand Press for 7-mm, 3-mm, and 1-mm pellets Includes 7-mm, 3-mm, and 1-mm die sets, anvils, die collars, anvil ejectors and Dual Pellet Holder

OPTIONS AND REPLACEMENT PARTS

PART NUMBER	DESCRIPTION
161-5700	Dual Pellet Holder for 7-mm, 3-mm, and 1-mm pellets
161-1018	Single Pellet Holder for 7-mm pellets
160-8010	KBr Powder, 100 g
161-5050	Agate Mortar and Pestle, 50 mm
161-1027	Hand Press Body
161-1028	Die Set, 1-mm
161-1024	Die Set, 3-mm
161-1010	Die Set, 7-mm
161-1019	Die Sets, 1-, 3- and 7-mm
161-1011	7-mm Collar

Note: For more Hand Press options, please contact PIKE Technologies.

Evacuatable Pellet Press – For Preparation of High Quality Pellets



FEATURES

- Ideal for making high-quality KBr pellets
- Apply up to 20,000 lbs (9,071 kg) of pressure
- Evacuatable to prevent cloudy pellets
- Requires hydraulic press

The PIKE Technologies Evacuatable Pellet Press is the preferred accessory for making pellets for FTIR analysis. Preparation of KBr pellets with a 13-mm die and a hydraulic press is the most popular method used to make samples for transmission measurements. It is also required by a number of standardized procedures, including some USLP and ASTM methods. Advantages of this approach include the generation of high-quality pellets, reproducibility, and the ability to deal with relatively difficult samples.

The PIKE Evacuatable Pellet Press Kit features the following components: a stainless steel base with vacuum outlet, the main die block with a 13-mm cylinder, two polished anvils and a plunger. All components are made of hardened stainless steel and surfaces that come in contact with the sample are highly polished. Two O-rings are used to seal the base/die assembly and the plunger.

Pellet preparation involves placement of the anvil in the die chamber and covering it with the pre-measured amount of KBr/sample mix. The second anvil is placed on the sample and the plunger is inserted into the chamber. The entire assembly is placed in a hydraulic press and compressed (a vacuum line can be connected to the base to remove air from the sample). For analysis, the formed pellet is ejected from the die with an extractor and mounted onto a standard 2" x 3" sample holder.

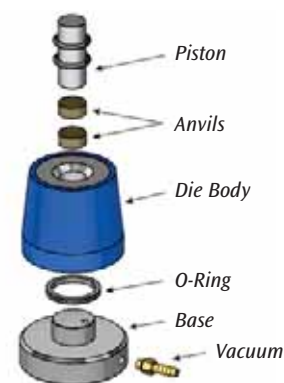

Evacuatable pellet press assembly.

ORDERING INFORMATION

PART NUMBER	DESCRIPTION
161-1900	Evacuatable Pellet Press for 13-mm pellets <i>Includes die block, anvils and pellet extracting tool</i>

OPTIONS AND REPLACEMENT PARTS

PART NUMBER	DESCRIPTION
160-8010	KBr Powder, 100 g
161-5050	Agate Mortar and Pestle, 50 mm
162-5300	Magnetic Film Holder for 13-mm pellets and film samples
162-5410	Sample Card for 13-mm pellets (10 ea.)
161-1908	Pellet Extracting Tool
161-1903	Anvils for PIKE Evacuatable Pellet Press (2 ea.)
161-1902	Pellet Die Piston
161-1906	Piston O-Rings (2 ea.)
161-1907	Base O-Rings (2 ea.)
430-1110	Vacuum Pump, 110V
430-1220	Vacuum Pump, 220V
161-1070	ShakIR, Heavy Duty Sample Grinder, 110/220V <i>Includes mount for 1" vials</i>
161-1035	ShakIR Stainless Steel Vial with Ball, 1" long x 0.5"+

Notes: ShakIR requires stainless steel vial and ball P/N 161-1035. For more Evacuatable Pellet Press options, please contact PIKE Technologies.

Pixie – Manual Hydraulic Pellet Press



The comprehensive Pixie Package provides all necessary components to start making pellets in the lab. It includes a 7-mm die, two extra pellet collars, pellet holder, pestle and mortar set, KBr powder and spatula. All die components are made of hardened stainless steel and the parallel surfaces that come in contact with the sample are highly polished for obtaining optimal pellet quality.



FEATURES

- 7-mm diameter die
- Applied force up to 2.5 tons
- Integrated force gauge
- Easy-to-use, ergonomic design
- Small footprint

PIKE Technologies introduces Pixie, a portable hydraulic press for making high-quality KBr pellets. With the press' ergonomic design, pellet making is easy and effortless. Pixie's small footprint makes it ideal for limited bench-space environments and glove boxes, and for storability. KBr pellets for IR transmission measurements are required by a number of standardized procedures, including some USLP and ASTM methods. Advantages of pellet making are spectral reproducibility and the ability to deal with relatively difficult or limited-mass samples.

The pellet preparation involves loading of the powdered KBr/sample matrix into the die chamber and placing the assembled die onto the platform of the hydraulic press. Force up to 2.5 tons may be applied. The die collar containing the newly formed pellet is placed into the designated holder and is positioned in the spectrometer's 2 x 3" slide mount holder for measurement.

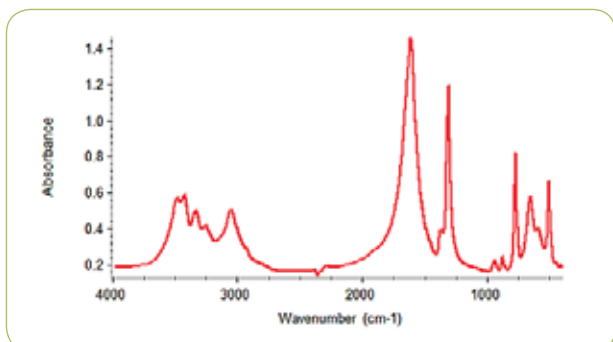

Spectrum of calciumoxalate hydrate; KBr pellet made with Pixie Press.

SPECIFICATIONS

	Metric	English
Ram Force, max	2.3 metric tons	2.5 tons
Platen Diameter	20.2 mm	0.8"
Die Height Range	22–39 mm	0.86–1.54"
Maximum Die Width	79 mm	3.11"
Mass	4.5 kg	10 lbs
Dimensions (W x D x H)		
	Metric	English
	127 x 192 x 201 (min.) mm	5.0 x 7.8 x 7.9 (min.)"

ORDERING INFORMATION

PART NUMBER	DESCRIPTION
181-1410	Pixie Hydraulic Press Package <i>Includes Pixie Hydraulic Press, 7-mm die set with two additional die collars, pellet holder, 35-mm agate mortar, KBr (50 g) and spoon spatula</i>
162-1010	Premium Transmission Sampling Kit <i>Includes Pixie hydraulic pellet press, sample preparation tools, mull liquids, cells, windows and cell holders required for preparation and analysis of solid and liquid samples</i>
181-1400	Pixie Hydraulic Press

OPTIONS AND REPLACEMENT PARTS

PART NUMBER	DESCRIPTION
161-1010	7-mm Die Set
161-1018	Single Pellet Holder for 7-mm pellets
161-1011	7-mm Collar
160-8010	KBr Powder, 100 g
161-5035	Agate Mortar and Pestle, 35 mm
042-3035	Spatula, spoon style
042-3050	Spatula, flat style

CrushIR – Digital Hydraulic Press



FEATURES

- Up to 15 tons of force
- Digital force readout for exceptional reproducibility
- Adjustable maximum force
- Small footprint
- Transparent safety shield

PIKE Technologies offers an advanced hydraulic press for making excellent-quality KBr pellets and thin films for transmission FTIR analysis. With its integrated digital force reading, the CrushIR™ provides exceptional reproducibility.

The PIKE CrushIR features a small footprint and includes a transparent protective shield, making it safe for operation in a busy laboratory environment. Access for vacuum hose and other utilities is made through a port in the rear of the press.

The adjustable top screw provides flexibility for die designs of short and longer dimensions yielding an open stand range from 2" to 4" (5 to 11.5 cm). The efficient sized ram stroke of 0.2" (5 mm) and adjustment screw speeds pellet making by minimizing the time required to achieve the desired force. All mechanical components of the press are enclosed in a safety metal cabinet.

The PIKE Evacuatable Pellet Press and 13-mm pellet holder are an excellent addition to the PIKE CrushIR. A packaged version of these 3 products is available.

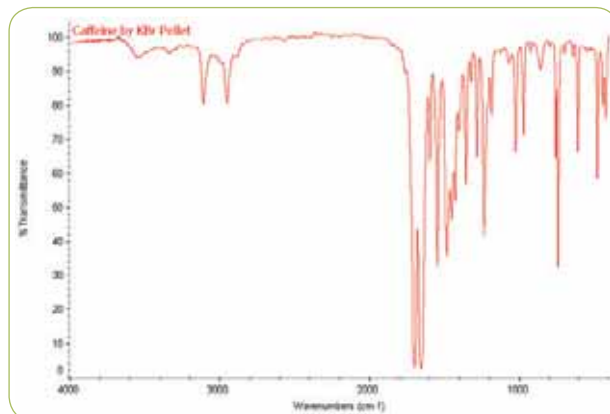

FTIR spectrum of caffeine in KBr pellet made using the PIKE CrushIR Hydraulic Press and Evacuatable Pellet Press.

SPECIFICATIONS

	Metric	English
Clamp Force, max	13.6 metric tons	15 US tons
Platen Diameter	100 mm	3.94"
Ram Stroke	5 mm	0.2"
Die Height Range	5–11.5 cm	2–4"
Dimensions (W x D x H)	31 x 25 x 35 cm	12 x 9.8 x 13.5"
Mass	23.6 kg	52 lbs
Input Voltage	90–264 V, auto setting, external power supply	
Output Voltage	9 VDC/18 W	

ORDERING INFORMATION

HYDRAULIC PRESS (select one)

PART NUMBER	DESCRIPTION
181-1100	PIKE CrushIR Hydraulic Press
181-1110	PIKE CrushIR Hydraulic Press, Evacuatable Pellet Press and Magnetic Holder
181-1120	PIKE CrushIR Heated Platens Package <i>Includes CrushIR, Heated Platens and Digital Temperature Control Module</i>

Note: The PIKE CrushIR Hydraulic Press includes an integrated safety shield.

OPTIONS AND REPLACEMENT PARTS

PART NUMBER	DESCRIPTION
161-1900	Evacuatable Pellet Press for 13-mm pellets
160-8010	KBr Powder, 100 g
161-5050	Agate Mortar and Pestle, 50 mm
162-5300	Magnetic Film Holder for 13-mm pellets
162-5410	Sample Card for 13-mm pellets (10 ea.)
430-1110	Vacuum Pump, 110V
430-1220	Vacuum Pump, 220V
161-1070	ShakIR, Heavy Duty Sample Grinder, 110/220V
161-1035	Stainless Steel Vial with Ball for ShakIR

Notes: ShakIR requires stainless steel vial and ball P/N 161-1035. For more Evacuatable Pellet Press options, please contact PIKE Technologies.

PressPRO – Programmable Hydraulic Press



FEATURES

- Variable force from 1 to 15 US tons
- Microprocessor controlled, consistent and reproducible force application for quality pellet making
- Easy to use touch-screen programming
- Small footprint
- Wide access door with transparent window and safety interlock

The PIKE PressPRO microprocessor controlled automated hydraulic press introduces an element of consistency into hydraulic press applications such as KBr pellet making. Pressure and corresponding hold time are easily entered through its integrated touch-screen control panel. Up to four pressure hold time and ramps may be programmed and performed within a run. During operation the force measurement is shown on the bright color display. This level of control enhances the uniformity and quality of transmission samples.

PressPRO is equipped with a wide access door that allows for easy insertion and removal of the pellet press. The door features an impact resistant, polycarbonate window and safety interlock which prevents operation while the door is open, making it safe for operation in a busy laboratory environment.

The adjustable screw at the top of the press provides flexibility for short and tall die designs, yielding an open stand range from 2 to 4.5" (5 to 11.5 cm). The optimal ram stroke of 0.45" (12 mm) and easy top screw adjustment speed-up pellet making by reducing time required to achieve the desired force.

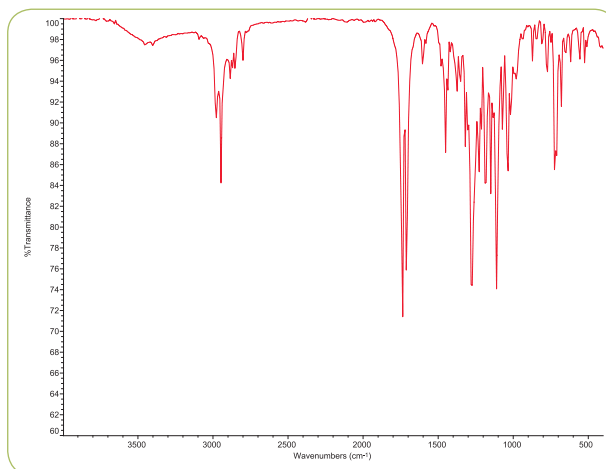

FTIR spectrum of caffeine in KBr pellet made using the PIKE PressPRO Hydraulic Press and Evacuatable Pellet Press.

SPECIFICATIONS

	Metric	English
Clamp Force, max	13.6 metric tons	15.0 US tons
Force Resolution	0.09 metric ton	0.10 US ton
Platen Diameter	100 mm	3.94"
Ram Stroke	12 mm	0.45"
Die Height Range	2.5–11.5 cm	1–4.5"
Dimensions (W x D x H)	24 x 43 x 34 cm	9.5 x 17 x 13.5
Weight	37.0 kg	81.6 lbs
Input Voltage	100–240 VAC auto setting external power supply	
Operating Voltage	6A/24 VDC, 150 W	

ORDERING INFORMATION

HYDRAULIC PRESS (select one)

PART NUMBER	DESCRIPTION
181-1320	PIKE PressPRO Hydraulic Press
181-1325	PIKE PressPRO Hydraulic Press, Evacuatable Pellet Press and Magnetic Holder

Note: The PIKE PressPRO Hydraulic Press includes an integrated safety shield.

OPTIONS AND REPLACEMENT PARTS

PART NUMBER	DESCRIPTION
161-1900	Evacuatable Pellet Press for 13-mm pellets
160-8010	KBr Powder, 100 g
161-5050	Agate Mortar and Pestle, 50 mm
162-5300	Magnetic Film Holder for 13-mm pellets
162-5410	Sample Card for 13-mm pellets (10 ea.)
430-1110	Vacuum Pump, 110V
430-1220	Vacuum Pump, 220V
161-1070	ShakIR, Heavy Duty Sample Grinder, 110/220V
161-1035	Stainless Steel Vial with Ball for ShakIR

Notes: ShakIR requires stainless steel vial and ball P/N 161-1035. For more Evacuatable Pellet Press options, please contact PIKE Technologies.

Heated Platens Accessory – For Making Thin Films of Polymeric Samples for Transmission FTIR Analysis



FEATURES

- Fast, efficient means of making thin films for transmission spectroscopy
- Temperature range – ambient to 300 °C
- Standard stainless steel spacer set (15, 25, 50, 100, 250 and 500 microns all with 25-mm ID) included with accessory
- Integral design for easy insertion and removal of heated platens into the hydraulic press
- Included insulating disks to minimize heat loss during film pressing
- Standard cooling chamber included

The PIKE Heated Platens Accessory is designed to efficiently make thin films of polymer materials for infrared transmission spectroscopy. IR transmission spectra of thin films, which are made from polymer pellets or other plastic sample forms, offer more sensitivity than typical ATR spectra. Polymer films are ideal for investigating polymer additives.

Typically a 2–5 milligram portion of polymer is cut from the pellet or other plastic sample and placed between aluminum disks within the heated base of the platens. The temperature of the platens is chosen to match the melting point of the polymer material. The top plate of the heated platens accessory is placed over the assembly and the unit is inserted into the hydraulic press. A low force (2 tons) is generally applied to the sample in the heated platens accessory to make excellent films.

The PIKE Heated Platens Accessory includes insulating disks to maintain the desired temperature at the sample's melting point when making thin polymer films. These insulating disks improve

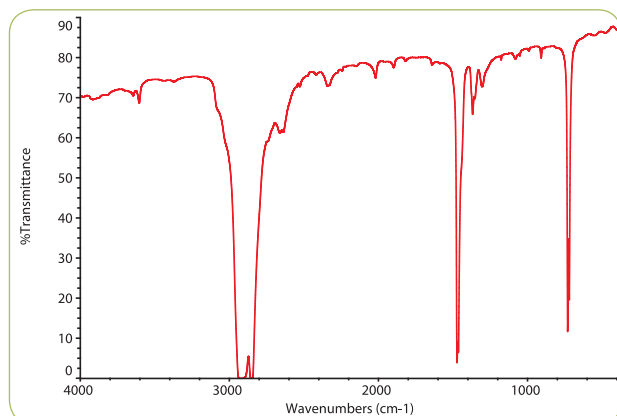

Transmission spectrum of thin film of high-density polyethylene produced from PIKE Heated Platens Accessory.

the quality of thin films by making them more IR transmissive. Flattening the polymer below its melting point produces a cloudy film. Pressing the polymer film when it is above its melting point may cause polymer degradation.

The PIKE Heated Platens Accessory is compatible with the PIKE CrushIR™ Hydraulic Press and other hydraulic presses (please inquire).

SPECIFICATIONS

Composition	Stainless steel platens, mirrored surfaces
Temperature Range	Ambient to 300 °C
Temperature Stability	Insulated, < 3 °C loss at 125 °C set point during press of film
Input Voltage	100–240 VAC, auto setting, external power supply
Operating Voltage	24 VDC/100 W
Sensor Type	3 wire Pt RTD (low drift, high stability)
Heating Time	Ambient to 100 °C, less than 7 minutes
Cooling Chamber	Standard, convection via liquid circulation (not supplied)
Pressing Height	3.3 cm
Spacer Thickness	15, 25, 50, 100, 250 and 500 microns
Spacer ID	25 mm
Dimensions (W x D x H)	64 x 264 x 52 mm
Maximum Force	5 US tons

ORDERING INFORMATION

PART NUMBER	DESCRIPTION
181-2000	PIKE Heated Platens Accessory
181-1120	PIKE CrushIR Heated Platens Package <i>Includes CrushIR hydraulic press, Heated Platens and digital temperature control module</i>

Notes: The Heated Platens Accessory includes spacer set, thermal insulating disks, cooling chamber, aluminum disks and magnetic film holder. P/N 181-2000 requires selection of temperature controller below.

TEMPERATURE CONTROLLER FOR HEATED PLATENS (must select)

PART NUMBER	DESCRIPTION
076-1220	Digital Temperature Control Module

Note: The digital temperature controller is required for operation of the Heated Platens Accessory.

OPTIONS AND REPLACEMENT PARTS

PART NUMBER	DESCRIPTION
181-3000	Spacer Set, 15, 25, 50, 100, 250, 500 microns
181-3020	Aluminum Disks (50 ea.)
181-3010	Spacer, 15 micron
181-3011	Spacer, 25 micron
181-3012	Spacer, 50 micron
181-3013	Spacer, 100 micron
181-3014	Spacer, 250 micron
181-3015	Spacer, 500 micron
162-5300	Magnetic Film Holder for 13-mm pellets and film samples
162-5410	Sample Card for 13-mm pellets (10 ea.)

Note: See page 113 for more film holder options.

ShakIR and Super ShakIR – For Optimized Sample Grinding



Standard ShakIR



Super ShakIR

FEATURES

- Produce finely powdered mix of sample and diluent – ideal for clear pellets and excellent diffuse reflectance spectra
- Minimize exposure of sample to atmospheric moisture – a chief cause of cloudy pellets
- Options for grinding ordinary and difficult samples
- Built-in safety features

ShakIR accessories provide a fast and simple method of mixing and grinding samples for diffuse reflectance sampling and in preparation for making KBr pellets. A small amount of sample or the IR transparent diluent (typically KBr) is simply scooped into a vial with mixing ball. The accessory thoroughly mixes and pulverizes the contents within seconds.

The standard ShakIR uses reciprocating motion of the vial holder that follows a “figure 8” path. The vial is swung through a 5 degree arc at high RPMs causing the ball to strike the end of the vial, which is sufficient to grind most materials into a powder.

The accessory provides electronic control for precise and reproducible setting of grinding time up to 95 seconds. The protective shield provides security to grinder operation. The ShakIR construction and weight offer long-term, reliable operation and minimized vibration and noise. The ShakIR features a small footprint. The base is 15 cm x 18 cm with a height of 28 cm.

The Super ShakIR also uses “figure 8” reciprocating motion for sample grinding, plus it offers more control over grinding speed and time intervals – specifically, 6 RPM levels from 2500 to 4600 are available and samples can be ground from 5 to 60 seconds. This provides a wide range of settings for bringing even very difficult samples to fine powder consistency quickly.

The Super ShakIR features a heavy-duty metal body with a chemically-resistant stainless steel grinding chamber. The unit operates quietly, regardless of RPM settings. The grinding chamber is protected by the door with a viewing window. For safety, the accessory will not operate until the door is fully closed. The Super ShakIR footprint is 18 cm x 28 cm and its height is 16 cm.

ORDERING INFORMATION

SHAKIR

PART NUMBER	DESCRIPTION
161-1070	ShakIR, Heavy Duty Sample Grinder, 110/220V <i>Includes mount for 1" vials</i>

SHAKIR VIALS (required)

PART NUMBER	DESCRIPTION
161-1035	Stainless Steel Vial with Ball, 1" long x 0.5"

OPTIONS AND REPLACEMENT PARTS FOR SHAKIR

PART NUMBER	DESCRIPTION
161-1037	Spare Stainless Steel Ball
160-8010	KBr Powder, 100 g

SUPER SHAKIR

PART NUMBER	DESCRIPTION
161-1080	Super ShakIR, Sample Grinder, 110/220V <i>Includes mount for 1.7" vials with 2 end-cups, a stainless steel vial, 50 stainless steel balls and a bullet-shaped bead</i>

OPTIONS AND REPLACEMENT PARTS FOR SUPER SHAKIR

PART NUMBER	DESCRIPTION
161-1038	Bullet-Shaped Bead
161-1039	Stainless Steel Vial, 1.7" long
161-1041	Stainless Steel Balls, assorted sizes (50 pieces)
161-1036	Polymer Vials (20 ea.)

Sample Preparation Accessories – For Solid Material Analysis (powders, mull agents, grinding tools and more)



FEATURES

- Accessories for analysis of solids by transmission and diffuse reflectance
- Materials for pellets and mulls

Preparation of samples for FTIR analysis by diffuse reflection or transmission analysis requires a number of tools and accessories for convenient and high quality results. PIKE Technologies has assembled these tools to make your FTIR sampling easier.

IR transparent powders and chunks, mulling agents and manual sample grinding tools with a complete selection of agate mortars and pestles are in stock and ready for immediate delivery.

ORDERING INFORMATION

IR TRANSPARENT POWDERS

PART NUMBER DESCRIPTION

160-8010	KBr Powder, 100 g
----------	-------------------

IR TRANSPARENT CHUNKS

PART NUMBER DESCRIPTION

160-8015	KBr Chunks, 100 g
----------	-------------------

AGATE MORTAR AND PESTLES

PART NUMBER DESCRIPTION

161-5035	Agate Mortar and Pestle, 35 mm
161-5040	Agate Mortar and Pestle, 40 mm
161-5050	Agate Mortar and Pestle, 50 mm
161-5065	Agate Mortar and Pestle, 65 mm
161-5095	Agate Mortar and Pestle, 95 mm
161-5100	Agate Mortar and Pestle, 100 mm
161-5225	Agate Mortar and Pestle, 125 mm
161-5150	Agate Mortar and Pestle, 150 mm

Note: The 50-mm Agate Mortar and Pestle is our most popular size and recommended for most applications.

SPATULAS FOR SOLIDS AND MULLS

PART NUMBER DESCRIPTION

042-3035	Spatula – spoon
042-3050	Spatula – flat

MULLING AGENTS

PART NUMBER DESCRIPTION

161-0500	Nujol®
161-0510	Fluorolube®

Note: For more sample preparation tool options contact PIKE Technologies.

Sample Holders – For Transmission FTIR Analysis of Pellets and Films

All PIKE Technologies transmission holders are constructed of high-quality materials and feature a 2" x 3" standard slide mount compatible with all FTIR spectrometers.



Universal Sample Holder



Heavy-Duty Magnetic Film Holder



Magnetic Film/Pellet Holder



Press-On Demountable Cell Holders



Single Pellet Holder



Dual Pellet Holder



Sampling Cards



Bolt Press and Gas Cell Holders

The **Universal Sample Holders** feature a spring-loaded mechanism which conveniently keeps in place films, salt plates, KBr pellets and other materials. The clear aperture of the holders is 20 mm and 10 mm. This universal holder offers great sample mounting flexibility.

The **Heavy-Duty Magnetic Film Holder** is designed to hold thick polymer materials and other transmission samples. The holder features a large size magnet and steel plate with a 20-mm aperture.

The **Magnetic Film/Pellet Holder** is used to mount KBr pellets and thin polymer films. Its components include a steel plate and flexible magnetic strip. The holder is designed to support 13-mm KBr pellets and films less than 0.5-mm thick.

Press-On Demountable Cell Holders are used for the analysis of smears and mulls. Available in 25-mm and 38-mm versions, both include mounting plate and pressure cap. Windows and spacers must be ordered separately.

The **Single Pellet Holder** for 7-mm KBr pellets is designed for use with the PIKE Technologies Hand Press and Pixie Hydraulic Press. For making only 7-mm pellets, this version is more convenient than the Dual Pellet Holder.

A **Dual Pellet Holder** for 1-, 3- and 7-mm KBr pellet collars features semi-circular mounts with slots accommodating specified size pellets as made using the PIKE Technologies Hand Press.

The PIKE Technologies **Sampling Cards** are inexpensive sample holders for analysis of films, polymers, 13-mm KBr pellets and other materials. Self-adhesive treated sides make sample preparation easy. The cards also offer compact and convenient means of sample storage.

Bolt Press and Gas Cell Holders – three different sizes are available. Each holder has detachable support rods for different sized accessories. The holders can also be used for placing salt plates and other large samples.

ORDERING INFORMATION

PART NUMBER	DESCRIPTION
162-5600	Universal Sample Holder, 20-mm aperture*
162-5610	Universal Sample Holder, 10-mm aperture*
162-5500	Heavy-Duty Magnetic Film Holder
162-5300	Magnetic Film Holder for 13-mm pellets and film samples
162-3600	Press-On Demountable Cell Holders for 25-mm windows
162-3610	Press-On Demountable Cell Holders for 32-mm windows
161-1018	Single Pellet Holder
161-5700	Dual Pellet Holder*
162-5410	Sample Card for 13-mm pellets (10 ea.)*
162-5400	Film Sampling Card, 20-mm aperture (10 ea.)*
161-2520	Bolt Press Holder
162-2105	Gas Cell Holder, 25 mm x 50 or 100 mm
162-2205	Gas Cell Holder, 38 mm x 50 or 100 mm

Notes: For more sample holder options, please contact PIKE Technologies. Holders marked "*" fit all standard 2" x 3" slide mounts, but due to their height may not allow for a complete sample compartment door closure on some smaller spectrometers. Please consult PIKE Technologies before placing an order.

REPLACEMENT PARTS

PART NUMBER	DESCRIPTION
162-5611	O-Rings for 20-mm Universal Sample Holder (6 ea.)
162-5612	O-Rings for 10-mm Universal Sample Holder (6 ea.)

Disks, Windows and Powders – For Transmission FTIR Analysis of Solid and Liquid Samples

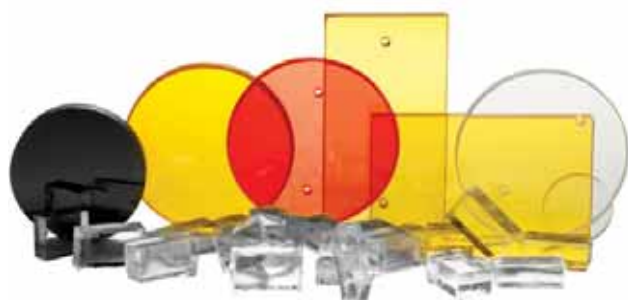

PIKE Technologies offers premier stock window and crystal materials – a carefully selected range of IR transparent materials most often used by IR spectroscopists. They fit PIKE accessories and cell holders available from other vendors. All windows, crystals and powders are made from the best quality material. The optical components are individually packaged and silica gel is included with those materials which are affected by humidity. **Products highlighted in red** are in stock and available for immediate delivery. Please refer to the next pages for full range of IR optical materials, windows and crystals.

Note: Save on price and shipping cost by selecting 6-pack versions of popular crystals.

ORDERING INFORMATION

Powders

PART NUMBER	DESCRIPTION
160-8010	KBr Powder, 100 g

Chunks

PART NUMBER	DESCRIPTION
160-8015	KBr Chunks, 100 g



Disks, 13 mm Diameter

1 mm THICKNESS

PART NUMBER	DESCRIPTION
160-5003	KBr, 13 x 1 mm
160-5004	NaCl, 13 x 1 mm
160-1149	BaF ₂ , 13 x 1 mm
160-5001	CaF ₂ , 13 x 1 mm

2 mm THICKNESS

PART NUMBER	DESCRIPTION
160-1301	AMTIR, 13 x 2 mm
160-1218	BaF ₂ , 13 x 2 mm
160-1213	CaF ₂ , 13 x 2 mm
160-1198	CsI, 13 x 2 mm
160-1191	Ge, 13 x 2 mm
160-1135	KBr, 13 x 2 mm
160-1008	KBr, 13 x 2 mm (6-pack)
160-1173	KRS-5, 13 x 2 mm
160-1170	NaCl, 13 x 2 mm
160-1005	NaCl, 13 x 2 mm (6-pack)
160-5201	SiO ₂ , 13 x 2 mm
160-5120	SiO ₂ , low OH, 13 x 2 mm
160-1160	Si, 13 x 2 mm
160-1241	ZnS, 13 x 2 mm
160-1115	ZnSe, 13 x 2 mm
160-1001	ZnSe, 13 x 2 mm (6-pack)

Disks, 20 mm Diameter

2 mm THICKNESS

PART NUMBER	DESCRIPTION
160-1148	BaF ₂ , 20 x 2 mm
160-1144	CaF ₂ , 20 x 2 mm
160-1197	CsI, 20 x 2 mm
160-1139	Ge, 20 x 2 mm
160-1134	KBr, 20 x 2 mm
160-1128	KRS-5, 20 x 2 mm
160-1169	NaCl, 20 x 2 mm
160-5211	Polyethylene, 20 x 2 mm
160-5119	SiO ₂ , 20 x 2 mm
160-5121	SiO ₂ , low OH, 20 x 2 mm
160-1118	Si, 20 x 2 mm
160-5118	ZnS, 20 x 2 mm
160-1304	ZnSe, 20 x 2 mm

Disks, 25 mm Diameter

2 mm THICKNESS

PART NUMBER	DESCRIPTION
160-1201	AMTIR, 25 x 2 mm
160-1306	BaF ₂ , 25 x 2 mm
160-1212	CaF ₂ , 25 x 2 mm
160-1002	CaF ₂ , 25 x 2 mm (6-pack)
160-1308	CsI, 25 x 2 mm
160-1307	Ge, 25 x 2 mm
160-1305	KBr, 25 x 2 mm
160-1172	KRS-5, 25 x 2 mm
160-1168	NaCl, 25 x 2 mm
160-1004	NaCl, 25 x 2 mm (6-pack)
160-5213	Polyethylene, 25 x 2 mm
160-5086	SiO ₂ , 25 x 2 mm
160-5122	SiO ₂ , low OH, 25 x 2 mm
160-1117	Si, 25 x 2 mm
160-5084	ZnS, 25 x 2 mm
160-1155	ZnSe, 25 x 2 mm
160-1007	ZnSe, 25 x 2 mm (6-pack)

ORDERING INFORMATION

Disks, 25 mm Diameter

4 mm THICKNESS

PART NUMBER	DESCRIPTION
160-1217	BaF ₂ , 25 x 4 mm
160-1211	CaF ₂ , 25 x 4 mm
160-1196	CsI, 25 x 4 mm
160-1138	Ge, 25 x 4 mm
160-1133	KBr, 25 x 4 mm
160-1009	KBr, 25 x 4 mm (6-pack)
160-1127	KRS-5, 25 x 4 mm
160-1124	NaCl, 25 x 4 mm
160-1012	NaCl, 25 x 4 mm (6-pack)
160-5214	Polyethylene, 25 x 4 mm
160-5089	SiO ₂ , 25 x 4 mm
160-5123	SiO ₂ , low OH, 25 x 4 mm
160-1116	Si, 25 x 4 mm
160-5087	ZnS, 25 x 4 mm
160-1114	ZnSe, 25 x 4 mm
160-1109	ZnSe, double AR coated, 25 x 4 mm
160-1110	ZnSe, single AR coated, 25 x 4 mm

5 mm THICKNESS

PART NUMBER	DESCRIPTION
160-1311	BaF ₂ , 25 x 5 mm
160-1210	CaF ₂ , 25 x 5 mm
160-1316	CsI, 25 x 5 mm
160-1313	Ge, 25 x 5 mm
160-1189	KBr, 25 x 5 mm
160-1003	KBr, 25 x 5 mm (6-pack)
160-1312	KRS-5, 25 x 5 mm
160-1123	NaCl, 25 x 5 mm
160-1011	NaCl, 25 x 5 mm (6-pack)
160-5100	SiO ₂ , 25 x 5 mm
160-5124	SiO ₂ , low OH, 25 x 5 mm
160-5090	ZnS, 25 x 5 mm
160-1154	ZnSe, 25 x 5 mm

Disks, 32 mm Diameter

3 mm THICKNESS

PART NUMBER	DESCRIPTION
160-1200	AMTIR, 32 x 3 mm
160-1199	AMTIR, drilled, 32 x 3 mm
160-1147	BaF ₂ , 32 x 3 mm
160-1017	BaF ₂ , 32 x 3 mm (6-pack)
160-1146	BaF ₂ , drilled, 32 x 3 mm
160-1018	BaF ₂ , drilled, 32 x 3 mm (6-pack)
160-1143	CaF ₂ , 32 x 3 mm
160-1142	CaF ₂ , drilled, 32 x 3 mm
160-1195	CsI, 32 x 3 mm
160-1194	CsI, drilled, 32 x 3 mm
160-1137	Ge, 32 x 3 mm
160-1136	Ge, drilled, 32 x 3 mm
160-1132	KBr, 32 x 3 mm
160-1010	KBr, 32 x 3 mm (6-pack)
160-1131	KBr, drilled, 32 x 3 mm
160-1015	KBr, drilled, 32 x 3 mm (6-pack)
160-1126	KRS-5, 32 x 3 mm
160-1125	KRS-5, drilled, 32 x 3 mm
160-1122	NaCl, 32 x 3 mm
160-1013	NaCl, 32 x 3 mm (6-pack)
160-1121	NaCl, drilled, 32 x 3 mm
160-1014	NaCl, drilled, 32 x 3 mm (6-pack)
160-5216	Polyethylene, 32 x 3 mm
160-5215	Polyethylene, drilled, 32 x 3 mm
160-5049	SiO ₂ , 32 x 3 mm
160-5125	SiO ₂ , low OH, 32 x 3 mm
160-5052	SiO ₂ , drilled, 32 x 3 mm
160-5126	SiO ₂ , drilled, low OH, 32 x 3 mm
160-1159	Si, 32 x 3 mm
160-1158	Si, drilled, 32 x 3 mm
160-5047	ZnS, 32 x 3 mm
160-5048	ZnS, drilled, 32 x 3 mm
160-1113	ZnSe, 32 x 3 mm
160-1112	ZnSe, drilled, 32 x 3 mm

Disks, 37.5 mm Diameter

4 mm THICKNESS

PART NUMBER	DESCRIPTION
160-1281	BaF ₂ , 37.5 x 4 mm
160-1286	ZnSe, 1-side AR coated, 37.5 x 4 mm
160-1287	CaF ₂ , 37.5 x 4 mm
160-1288	KBr, 37.5 x 4 mm
160-1289	KCl, 37.5 x 4 mm
160-1290	NaCl, 37.5 x 4 mm
160-1291	ZnSe, 37.5 x 4 mm

Disks, 38 mm Diameter

3 mm THICKNESS

PART NUMBER	DESCRIPTION
160-1349	BaF ₂ , 38 x 3 mm
160-1350	Ge, 38 x 3 mm
160-5220	KBr, 38 x 3 mm
160-1344	KRS-5, 38 x 3 mm
160-5218	Polyethylene, 38 x 3 mm
160-1233	SiO ₂ , 38 x 3 mm
160-5127	SiO ₂ , low OH, 38 x 3 mm
160-1353	Si, 38 x 3 mm
160-1315	ZnS, 38 x 3 mm
160-5025	ZnSe, 38 x 3 mm

6 mm THICKNESS

PART NUMBER	DESCRIPTION
160-1357	AMTIR, 38 x 6 mm
160-1322	BaF ₂ , 38 x 6 mm
160-1342	CaF ₂ , 38 x 6 mm
160-1326	CsI, 38 x 6 mm
160-1323	Ge, 38 x 6 mm
160-1320	KBr, 38 x 6 mm
160-1343	KRS-5, 38 x 6 mm
160-1321	NaCl, 38 x 6 mm
160-5219	Polyethylene, 38 x 6 mm
160-1355	SiO ₂ , 38 x 6 mm
160-5128	SiO ₂ , low OH, 38 x 6 mm
160-1324	Si, 38 x 6 mm
160-1329	ZnSe, 38 x 6 mm



Note: Products highlighted in red are in stock and available for immediate delivery.

ORDERING INFORMATION

Disks, 41 mm Diameter

3 mm THICKNESS

PART NUMBER	DESCRIPTION
160-1216	BaF ₂ , 41 x 3 mm
160-1209	CaF ₂ , 41 x 3 mm
160-1188	KBr, 41 x 3 mm
160-1167	NaCl, 41 x 3 mm
160-5217	Polyethylene, 41 x 3 mm
160-5157	ZnS, 41 x 3 mm
160-1341	ZnSe, 41 x 3 mm

Disks, 49 mm Diameter

3 mm THICKNESS

PART NUMBER	DESCRIPTION
160-5161	ZnS, 49 x 3 mm
160-1153	ZnSe, 49 x 3 mm

6 mm THICKNESS

PART NUMBER	DESCRIPTION
160-5027	BaF ₂ , 49 x 6 mm
160-5206	CaF ₂ , 49 x 6 mm
160-5029	CsI, 49 x 6 mm
160-1187	KBr, 49 x 6 mm
160-5205	KRS-5, 49 x 6 mm
160-1166	NaCl, 49 x 6 mm
160-5164	SiO ₂ , 49 x 6 mm
160-5129	SiO ₂ , low OH, 49 x 6 mm

Disks, 50 mm Diameter

3 mm THICKNESS

PART NUMBER	DESCRIPTION
160-5030	BaF ₂ , 50 x 3 mm
160-1208	CaF ₂ , 50 x 3 mm
160-5173	CsI, 50 x 3 mm
160-1186	KBr, 50 x 3 mm
160-1171	KRS-5, 50 x 3 mm
160-1165	NaCl, 50 x 3 mm
160-5177	ZnS, 50 x 3 mm
160-1152	ZnSe, 50 x 3 mm

Windows, 29 mm x 14 mm

4 mm THICKNESS

PART NUMBER	DESCRIPTION
160-1215	BaF ₂ , 29 x 14 x 4 mm
160-5010	BaF ₂ , drilled, 29 x 14 x 4 mm
160-1207	CaF ₂ , 29 x 14 x 4 mm
160-5011	CaF ₂ , drilled, 29 x 14 x 4 mm
160-5007	Ge, 29 x 14 x 4 mm
160-5012	Ge, drilled, 29 x 14 x 4 mm
160-1185	KBr, 29 x 14 x 4 mm
160-1184	KBr, drilled, 29 x 14 x 4 mm
160-5009	KRS-5, 29 x 14 x 4 mm
160-5014	KRS-5, drilled, 29 x 14 x 4 mm
160-1164	NaCl, 29 x 14 x 4 mm
160-1163	NaCl, drilled, 29 x 14 x 4 mm

Windows, 38 mm x 19 mm

2 mm THICKNESS

PART NUMBER	DESCRIPTION
160-1269	AMTIR, 38 x 19 x 2 mm
160-1270	AMTIR, drilled, 38 x 19 x 2 mm
160-1157	Si, 38 x 19 x 2 mm
160-1156	Si, drilled, 38 x 19 x 2 mm
160-1275	ZnS, 38 x 19 x 2 mm
160-1276	ZnS, drilled, 38 x 19 x 2 mm
160-1151	ZnSe, 38 x 19 x 2 mm
160-1150	ZnSe, drilled, 38 x 19 x 2 mm

4 mm THICKNESS

PART NUMBER	DESCRIPTION
160-1214	BaF ₂ , 38 x 19 x 4 mm
160-1145	BaF ₂ , drilled, 38 x 19 x 4 mm
160-1141	CaF ₂ , 38 x 19 x 4 mm
160-1140	CaF ₂ , drilled, 38 x 19 x 4 mm
160-1193	CsI, 38 x 19 x 4 mm
160-1192	CsI, drilled, 38 x 19 x 4 mm
160-1190	Ge, 38 x 19 x 4 mm
160-5032	Ge, drilled, 38 x 19 x 4 mm
160-1130	KBr, 38 x 19 x 4 mm
160-1129	KBr, drilled, 38 x 19 x 4 mm
160-5031	KRS-5, 38 x 19 x 4 mm
160-5016	KRS-5, drilled, 38 x 19 x 4 mm
160-1162	NaCl, 38 x 19 x 4 mm
160-1006	NaCl, 38 x 19 x 4 mm (6-pack)
160-1161	NaCl, drilled, 38 x 19 x 4 mm
160-1292	SiO ₂ , 38 x 19 x 4 mm
160-5130	SiO ₂ , low OH, 38 x 19 x 4 mm
160-1293	SiO ₂ , drilled, 38 x 19 x 4 mm
160-5131	SiO ₂ , drilled, low OH, 38 x 19 x 4 mm



Windows, 41 mm x 23 mm

3 mm THICKNESS

PART NUMBER	DESCRIPTION
160-1277	ZnS, 41 x 23 x 3 mm
160-1279	ZnS, drilled, 41 x 23 x 3 mm
160-1111	ZnSe, 41 x 23 x 3 mm
160-1280	ZnSe, drilled, 41 x 23 x 3 mm

6 mm THICKNESS

PART NUMBER	DESCRIPTION
160-5146	BaF ₂ , 41 x 23 x 6 mm
160-5152	BaF ₂ , drilled, 41 x 23 x 6 mm
160-5147	CaF ₂ , 41 x 23 x 6 mm
160-5153	CaF ₂ , drilled, 41 x 23 x 6 mm
160-1183	KBr, 41 x 23 x 6 mm
160-1182	KBr, drilled, 41 x 23 x 6 mm
160-1120	NaCl, 41 x 23 x 6 mm
160-1119	NaCl, drilled, 41 x 23 x 6 mm

Notes: For disk and window sizes other than shown here, please contact PIKE Technologies. Products highlighted in red are in stock and available for immediate delivery

Crystal Polishing Kit – Extending the Life of IR Transparent Windows



FEATURES

- Complete kit for polishing IR transparent windows
- Reduces cost of transmission analysis by extending KBr and NaCl window lifetime

Scratched and fogged windows diminish the quality of transmission FTIR spectra. Their continuous replacement can be impractical and quite expensive. A number of standard infrared windows can be quickly restored to quality condition with the PIKE Technologies Crystal Polishing Kit. The kit includes all the necessary components to re-polish KBr and NaCl windows quickly and effectively.

Note: We do not recommend polishing KRS-5 windows due to safety hazards and for this reason do not include materials for polishing KRS-5 windows.

ORDERING INFORMATION

PART NUMBER	DESCRIPTION
162-4000	Crystal Polishing Kit <i>Includes wooden base, glass plates, polishing pads, brushes and polishing compounds</i>

REPLACEMENT PARTS

PART NUMBER	DESCRIPTION
162-4010	Glass Plate
162-4011	Polishing Pads (6 ea.)
162-4015	Brushes (6 ea.)
162-4012	Grinding Compound, 400 grit
162-4013	Grinding Compound, 600 grit
162-4014	Polishing Compound

Note: For other options for window polishing, please contact PIKE Technologies.

Short-Path Gas Cells – For Samples with Higher Vapor Phase Concentration



100-mm
Short-Path
HT Cell

FEATURES

- Gas cells for measuring higher vapor phase concentration
- High throughput and economy versions
- 100-mm and 50-mm pathlengths
- Fits all FTIR spectrometers

PIKE Technologies offers several choices for analysis of gas samples with component concentrations generally above 1% by weight. Our Short-Path HT Gas Cells provide high throughput by virtue of their greater inside diameter providing more energy at the FTIR detector. The Short-Path HT Gas Cells also include glass stopcocks for flow input of the gas sample and sealing.

The PIKE Technologies Short-Path EC Gas Cells are recommended for use with occasional gas sampling and offer an economical choice with standard septum-styled sealing of the vapor phase sample.

Both our Short-Path HT and EC Gas Cells are available in 50-mm and 100-mm versions. The complete gas cell requires your selection of the appropriate IR transparent windows. Both HT and EC Gas Cells are slide mount accessories, compatible with all FTIR spectrometers.

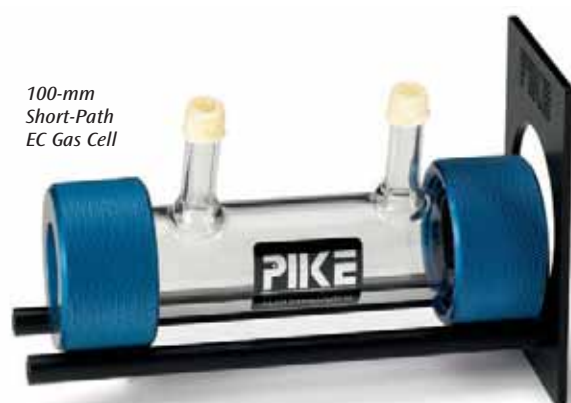

100-mm
Short-Path
EC Gas Cell

ORDERING INFORMATION

SHORT-PATH GAS CELLS

PART NUMBER	DESCRIPTION
162-2200	Short-Path HT Gas Cell, 100 mm pathlength
162-2250	Short-Path HT Gas Cell, 50 mm pathlength
162-2100	Short-Path EC Gas Cell, 100 mm pathlength
162-2150	Short-Path EC Gas Cell, 50 mm pathlength

Notes: The Short-Path Gas Cells include the glass body, o-rings and cell holder. HT Gas Cells require selection of two 38 x 6 mm windows. EC Gas Cells require selection of two 25 x 4 mm windows.

WINDOWS FOR SHORT-PATH GAS CELL

(must select minimum of 2)

38 x 6 mm	PART NUMBER		DESCRIPTION
	25 x 4 mm		
160-1322	160-1217		BaF ₂
160-1342	160-1211		CaF ₂
160-1320	160-1133		KBr
160-1321	160-1124		NaCl
160-1329	160-1114		ZnSe

Notes: For window compatibility please consult the Materials Properties table on page 128 of this catalog. Find additional window selections starting on page 114.

REPLACEMENT PARTS

HT GAS CELL	PART NUMBER		DESCRIPTION
	EC GAS CELL		
162-2209	162-2109		Viton O-Rings (2 ea.)
162-2202	162-2102		Cell Window Cap
162-2205	162-2105		Gas Cell Holder
162-2201	162-2101		Glass Body for 100-mm Cell
162-2255	162-2155		Glass Body for 50-mm Cell
162-2107	162-2106		Septum Caps (12 ea.)

Note: For options not shown here, please contact PIKE Technologies.

Heated Gas Flow Cell – For Streaming Gas Analysis



FEATURES

- High IR throughput, minimum cell volume ideal for preserving flowing gas composition
- Temperature control to 300 °C
- Your choice of IR transparent windows – user-changeable
- Compatible with most FTIR spectrometers

The PIKE Technologies Heated Gas Flow Cell is recommended for high-performance FTIR sampling of flowing gas samples. The beam-conforming design of the Heated Gas Flow Cell provides for low cell volume (38.5 mL) and a 100-mm pathlength, compatible with most FTIR spectrometers. This beam-conforming design also provides maximum IR throughput with no vignette of the IR beam. The gas cell may be heated up to 300 °C to prevent condensation of higher molecular weight gas species. The PIKE Technologies Heated Gas Flow Cell includes standard Swagelok® fittings for connection to 1/8" tubing and its stainless steel composition is compatible with pressurized applications up to 100 psi when using an appropriate IR window.

Temperature control is provided by either digital or digital PC controllers from PIKE Technologies. The Heated Gas Flow Cell requires selection of your choice of 38 x 6 mm IR transparent windows and temperature controller.

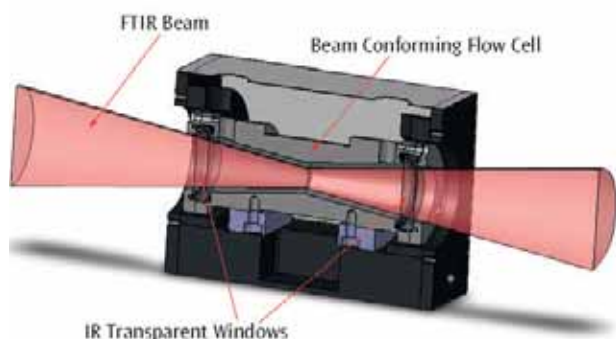

Optical geometry for PIKE Technologies Heated Gas Flow Cell.

SPECIFICATIONS

Temperature Range	Ambient to 300 °C
Accuracy	+/- 0.5% of set point
Voltage	24 VAC
Sensor Type	3 wire Pt RTD (low drift, high stability)
Controllers	
Input Voltage	115/230 V, switchable
Output Voltage	10 A/24 VAC
Dimensions (W x D x H)	91 x 140 x 121 mm (excludes baseplate mount)

ORDERING INFORMATION

PART NUMBER	DESCRIPTION
162-20XX	Heated Gas Flow Cell Includes cell, high-temp O-rings, and FTIR mounting plate

Note: Replace XX with your spectrometer's Instrument Code. [Click for List >](#)

TEMPERATURE CONTROLLERS (must select one)

PART NUMBER	DESCRIPTION
076-1410	Digital Temperature Control Module, PC Control
076-1210	Digital Temperature Control Module

Note: Digital Temperature Control Module, PC Control includes PIKE TempPRO software.

IR TRANSPARENT WINDOWS FOR HEATED GAS FLOW CELL

(select minimum of 2)

PART NUMBER	DESCRIPTION
160-1322	BaF ₂ Window, 38 x 6 mm
160-1320	KBr Window, 38 x 6 mm
160-1343	KRS-5 Window, 38 x 6 mm
160-1329	ZnSe Window, 38 x 6 mm

Notes: For window compatibility please consult the Windows Materials Properties table on page 128 of this catalog. Find additional window selections starting on page 114.

REPLACEMENT PARTS AND OPTIONS

PART NUMBER	DESCRIPTION
162-2009	Viton O-Rings, max. temp. 200 °C, (2 ea.)
162-2309	High-Temperature O-Rings, max. temp. 325 °C (1 ea.)
162-2308	High-Temperature O-Rings, max. temp. 325 °C (4 ea.)

Notes: Gas Cell requires 4 O-rings total. For high-temperature purge tubes and other options, please contact PIKE Technologies.

Low-Volume Heated Gas Cell – Near-Instantaneous Feedback on Compositional Changes



FEATURES

- Short pathlength, 10 or 12 cm
- Volume less than 5 ml
- Temperature control to 300 °C
- Precision transfer optics for beam focusing

The new Low-Volume Heated Gas Cell by PIKE Technologies is ideal for infrared applications such as determining and quantifying off-gassing and headspace species where gas volume is limited. At less than 5 ml, the gas cell volume is a fraction of that found in typical short-path gas cells of similar lengths (10 to 12 cm). It connects easily to simple gas flow experimental setups as an IR screening diagnostic tool. Due to its low internal volume, it offers near-instantaneous feedback on gas compositional changes.

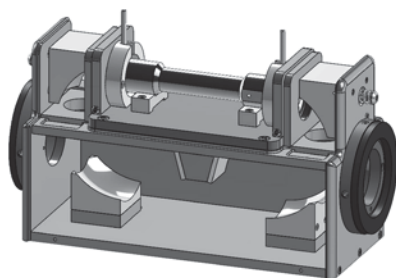

Optical geometry for PIKE Technologies' Low-Volume Heated Gas Cell.

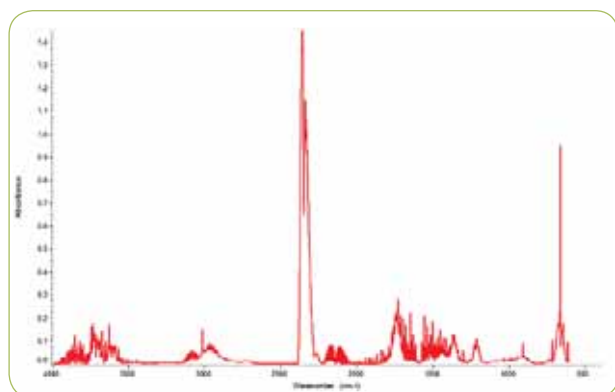

Volatiles from an ampoule filled with epoxy aged for 2 d at 240 °C; spectrum shows predominately H₂O and CO₂ with some evidence of CO, CH₄ and C₃H₆.

PIKE Technologies' Low-Volume Heated Gas Cell is an experimentally attractive, independent solution for the practitioner dealing with gas analysis and quantitative challenges. In the polymer materials field, for example, it offers simple gas compositional analysis of headspace volatiles originating in small-volume sealed material aging experiments.

To optimize the energy throughput, this unique cell uses a set of transfer optics that focuses the IR beam from the spectrometer onto the entrance of the 7-mm bore cell body. The interior of the gas cell body is highly polished and gold coated for maximum IR transmission. The gas cell may be heated up to 300 °C to prevent condensation of higher molecular weight gas species.

SPECIFICATIONS

Gas Cell Pathlength	10 or 12 cm
Gas Cell Diameter	7 mm
Gas Cell Volume	3.8 or 4.6 ml
Temperature Range	Ambient to 300 °C
Accuracy	+/- 0.5% of set point
Voltage	24 VAC
Sensor Type	3-wire Pt RTD (low drift, high stability)
Controllers	
Input Voltage	115/230V
Output Voltage	10A/24 VAC
Dimensions (W x D x H)	
12 cm pathlength	223 x 110 x 134 mm
10 cm pathlength	197 x 110 x 134 mm (excludes baseplate mount)
Gas Ports	1/8" tubing, welded

ORDERING INFORMATION

PART NUMBER DESCRIPTION

164-62XX Low-Volume Heated Gas Cell, 10 cm

164-61XX Low-Volume Heated Gas Cell, 12 cm

Note: Replace **XX** with your spectrometer's Instrument Code. [Click for List >](#)

TEMPERATURE CONTROLLERS (must select one)

PART NUMBER DESCRIPTION

076-1410 Digital Temperature Control Module, PC Control

076-1210 Digital Temperature Control Module

Note: Digital Temperature Controller, PC Control includes PIKE TempPRO software.

13 x 2 mm WINDOWS (must select minimum of two)

PART NUMBER	DESCRIPTION	PART NUMBER	DESCRIPTION
160-1218	BaF ₂	160-1170	NaCl
160-1213	CaF ₂	160-1115	ZnSe
160-1135	KBr	160-5201	SiO ₂

REPLACEMENT PARTS

PART NUMBER DESCRIPTION

164-6001 Viton O-Rings, max. temp. 200 °C (2 ea.)

164-6002 High-Temperature O-Rings, max. temp. 300 °C (2 ea.)

Note: Low-Volume Heated Gas Cell requires 4 O-rings total.

Stainless Steel Short-Path Gas Cells – For Measurement of High Concentration Vapor Components

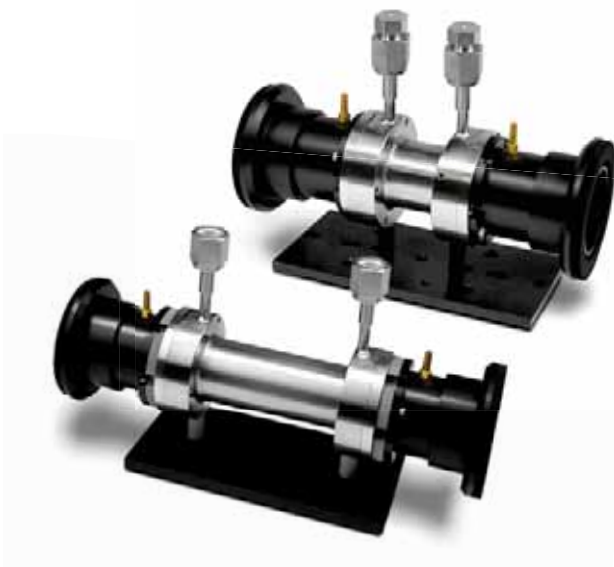

FEATURES

- Measurement of high concentration vapor phase samples
- Wide range of pathlengths, from 1 to 20 cm
- Heated option up to 300 °C
- Baseplate-mounted for stability in the sample compartment

For analyzing more concentrated gases, PIKE Technologies is offering Stainless Steel Short-Path Gas Cells. The durable construction of the metal body may be used under pressure when matched with a suitable IR window. Cell pathlengths are 1, 2, 5, 10, 15, and 20 cm. For maximum precision or to prevent condensation of specific components, heated models are available for a maximum temperature of 300 °C.



*Heated Stainless Steel
Short-Path Gas Cell*

SPECIFICATIONS

Temperature Range	Ambient to 300 °C
Accuracy	+/- 0.5% of set point
Voltage	115 or 230 VAC
Sensor Type	RTD
Controllers	
Digital Display	+/- 0.1 °C
Input Voltage	115/230 V, switchable
Output Voltage	10 A/24 VAC

All cells are delivered with welded VCR fittings. To offer the greatest flexibility, users may optimize their configuration further by choosing Swagelok valves with VCR or 1/4" compression termination. PIKE gas cells have been designed for easy maintenance and cleaning. Our gas cells are baseplate-mounted for stability in the spectrometer sample compartment and offer purge collars to eliminate atmospheric water vapor and CO₂ interferences in the spectrum.

Custom pathlengths and cell materials are available. Contact PIKE Technologies for special orders.



1/4" termination



Valve with VCR termination

ORDERING INFORMATION

STAINLESS STEEL SHORT-PATH GAS CELL

PART NUMBER DESCRIPTION

164-21XX	Stainless Steel Gas Cell, 1 cm
164-22XX	Stainless Steel Gas Cell, 2 cm
164-25XX	Stainless Steel Gas Cell, 5 cm
164-20XX	Stainless Steel Gas Cell, 10 cm
164-27XX	Stainless Steel Gas Cell, 15 cm
164-29XX	Stainless Steel Gas Cell, 20 cm

Notes: Replace **XX** with your spectrometer's Instrument Code. [Click for List >](#)
Windows not included; order separately. 1 and 2 cm pathlength gas cells use 25 x 4 mm windows and all others use 38 x 6 mm windows. Not all pathlengths fit commercial spectrometer sample compartments.

HEATED SHORT-PATH GAS CELLS

PART NUMBER DESCRIPTION

164-31XX	Heated Stainless Steel Gas Cell, 300 °C, 1 cm
164-32XX	Heated Stainless Steel Gas Cell, 300 °C, 2 cm
164-35XX	Heated Stainless Steel Gas Cell, 300 °C, 5 cm
164-30XX	Heated Stainless Steel Gas Cell, 300 °C, 10 cm

Notes: Replace **XX** with your spectrometer's Instrument Code. [Click for List >](#)
Windows not included; order separately. 1 and 2 cm pathlength gas cells use 25 x 4 mm windows and all others use 38 x 6 mm windows. Not all pathlengths and heating options fit commercial spectrometer sample compartments. High-temperature O-rings are included. Heated short-path gas cells include a digital temperature controller and heating assembly. Please contact PIKE Technologies for custom pathlengths.

IR TRANSPARENT WINDOWS FOR STAINLESS STEEL SHORT-PATH GAS CELL *(select minimum of 2)*

PART NUMBER		DESCRIPTION
25 x 4 mm (1, 2 cm)	38 x 6 mm (5, 10, 15, 20 cm)	
160-1217	160-1322	BaF ₂
160-1211	160-1342	CaF ₂
160-1133	160-1320	KBr
160-1127	160-1343	KRS-5
160-1124	160-1321	NaCl
160-1114	160-1329	ZnSe
160-1110	-----	ZnSe, Anti-Reflective Coating, 1-side
160-1109	-----	ZnSe, Anti-Reflective Coating, 2-sides

VALVES AND REPLACEMENT PARTS

PART NUMBER DESCRIPTION

164-4000	VCR Valve to VCR Termination Kit
164-4001	Valve to 1/4 inch Termination Kit
164-4002	1/4 inch Termination Kit
164-4006	Viton O-Rings, 25 mm, max. temp. 200 °C (2 ea.)
164-4008	Viton O-Rings, 38 mm, max. temp. 200 °C (2 ea.)
164-4007	High Temperature O-Rings, 25 mm, 300 °C (2 ea.)
164-4009	High Temperature O-Rings, 38 mm, 300 °C (2 ea.)

Notes: Fitting kits include one for inlet and one for outlet. Contact us for other fitting options. Gas cell requires 4 O-rings total.

Long-Path Gas Cells – For Measurement of Low Concentration Vapor Components

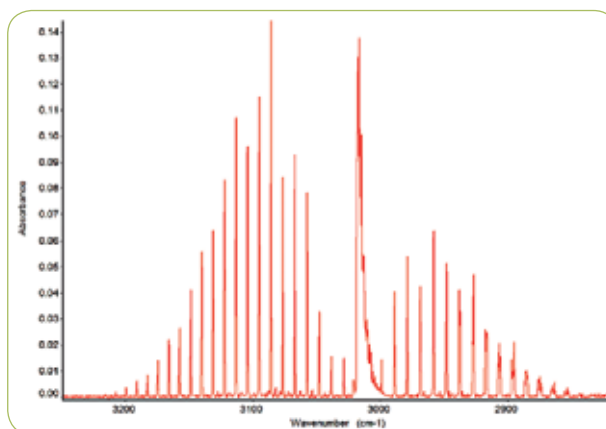

C-H stretch spectral region for methane gas.

The anodized aluminum base includes spectrometer-specific baseplate allowing placement of the accessory in the FTIR sample compartment. As a standard feature, the optical base is fully purgeable allowing for the elimination of atmospheric water vapor and CO₂ interference in the spectrum.

FEATURES

- Long-Path gas cells for measurements of vapor species to ppb levels
- Fixed and variable pathlength versions
- Heated versions available up to 200 °C
- Standard fully purgeable optics
- Fits most FTIR spectrometers

PIKE Technologies offers several Long-Path Gas Cells for analysis of trace components in gas samples – typical concentrations may range from the ppm to ppb levels. The Long-Path Cells feature a folded path design providing an extended pathlength within a compact dimension. The FTIR beam enters the cell through an IR transparent window and reflects a number of times between the accessory mirrors before exiting to the detector. The number of reflections is determined by the optical configuration of the cell and may be selected as a permanently aligned version or a user-adjustable version (variable-path cell). Typical applications include air pollution studies, gas purity determinations, monitoring of industrial processes, exhaust gas analysis and many others.

All Long-Path Gas Cells are manufactured by PIKE Technologies. The fixed and variable long-path body assemblies are nickel-coated aluminum, stainless steel or heavy-wall borosilicate glass. Gas cells may be operated under vacuum or pressure. The top of the cell is enclosed by the valve assembly with stainless steel Swagelok valves with barb fittings. Tube compression fittings are available upon request.

For optimal performance the mirrors have been diamond turned and coated with the highest quality gold for maximum reflectivity and inertness. The accessory mirrors are mounted permanently with mechanical mirror mounts to eliminate out-gassing chemicals that may occur when using epoxies to secure the mirrors. Windows are easily replaceable and a variety of window materials are available.



Variable-Path Gas Cell

The construction and main components of the variable-path gas cells are identical with those described above, with an exception of the internal mirror assembly. The cell has an adjustable mirror located at the top of the enclosure (position controlled with a micrometer) and one stationary mirror. Adjustments to the mirror position allow selection of different pathlengths supported by the cell. The variable-path gas cell has an integrated laser that enables the determination of the pathlength by counting the number of laser reflections on the bottom mirror.

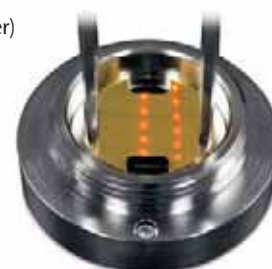

Laser reflections shown on the bottom mirror of the variable-path gas cell for pathlength determination.

LONG-PATH GAS CELL SPECIFICATIONS

	2.4 m Fixed	5.0 m Fixed	10.0 m Fixed	20.0 m Fixed	30.0 m Fixed	1–16 m Variable
Base Path (mm)	100	157	250	500	625	333
Body Material	Metal	Metal	Glass or Metal	Glass or Metal	Glass	Glass
Optics Coatings	Gold	Gold	Gold	Gold	Gold	Gold
Window Material	KBr	KBr	KBr	KBr	KBr	KBr
Window Dimension (mm)	37.5 x 4	25 x 4	25 x 4	25 x 4	25 x 4	25 x 4
# Window	1	2	2	2	2	2
Cell Volume (L)	0.1	0.5	2.2	7.2	12.8	3.5

HEATED LONG-PATH GAS CELL SPECIFICATIONS

Temperature Range	Ambient to 200 °C
Accuracy	+/- 0.5% of set point
Voltage	115 or 230 VAC
Sensor Type	RTD
Controllers	
Digital Display	+/- 0.1 °C
Input Voltage	115 or 230 V, specify
Output Voltage	115 or 230 VAC/10A, specify

Note: Other line voltages may require an additional transformer.

Some gas measurement applications require temperature control for higher precision or to prevent condensation of specific components. PIKE Technologies offers heated versions of our fixed- and variable-path gas cells up to 200 °C. For temperature accuracy, the temperature sensor has been embedded inside the gas cell as opposed to mounted on the exterior of the cell.

Contact PIKE Technologies on how to upgrade an existing cell to the heated version. Custom pathlengths, cell materials and heated transfer line are available. Contact us for special orders.



5-m Heated Gas Cell

ORDERING INFORMATION

LONG-PATH GAS CELLS

PART NUMBER	DESCRIPTION
163-12XX	2.4 m Metal Gas Cell
163-13XX	2.4 m Stainless Steel Gas Cell
163-15XX	5 m Metal Gas Cell
163-14XX	5 m Stainless Steel Gas Cell
163-10XX	10 m Metal Gas Cell
163-17XX	10 m Stainless Steel Gas Cell
163-11XX	10 m Glass Gas Cell
163-16XX	1–16v m Glass Gas Cell
163-18XX	20 m Stainless Steel Gas Cell
163-20XX	20 m Glass Gas Cell
163-30XX	30 m Glass Gas Cell

Notes: Replace **XX** with your spectrometer's Instrument Code. [Click for List >](#) Metal Gas Cell bodies are made of nickel-plated aluminum. Long-Path Gas Cells include KBr window(s) and Swagelok™ valves with barb fittings. Compression fittings are available upon request; specify size. Additional window materials can be ordered from the table in the next column.

REPLACEMENT PARTS

PART NUMBER	DESCRIPTION
076-1240	Long-Path Gas Cell Temperature Control Module
076-1440	Long-Path Gas Cell Temperature Control Module, PC control
163-1009	Pathlength Verification Tool, 2.4 m and 5 m
163-10910	Pathlength Verification Tool, 10 m and 20 m
163-1001	Viton Gas Cell Window O-Ring, 5, 10, 20, 16v m (4 ea.)
163-1208	Perfluoroelastomer O-Ring Kit, 2.4 m
163-1506	Perfluoroelastomer O-Ring Kit, 5 m
163-1007	Perfluoroelastomer O-Ring Kit, 10 m
163-2006	Perfluoroelastomer O-Ring Kit, 20 m

Note: Temperature control modules are 115/230 V switchable. PC control module includes PIKE Technologies' TempPRO software. Please call PIKE Technologies for replacement O-rings or other parts not listed here.

HEATED LONG-PATH GAS CELLS

PART NUMBER	DESCRIPTION
163-42XX	2.4 m Heated Metal Gas Cell, 115 V
163-42XX-30	2.4 m Heated Metal Gas Cell, 230 V
163-35XX	2.4 Heated Stainless Steel Gas Cell, 115 V
163-35XX-30	2.4 Heated Stainless Steel Gas Cell, 230 V
163-45XX	5 m Heated Metal Gas Cell, 115 V
163-45XX-30	5 m Heated Metal Gas Cell, 230 V
163-31XX	5 m Heated Stainless Steel Gas Cell, 115 V
163-31XX-30	5 m Heated Stainless Steel Gas Cell, 230 V
163-40XX	10 m Heated Metal Gas Cell, 115 V
163-40XX-30	10 m Heated Metal Gas Cell, 230 V
163-32XX	10 m Heated Stainless Steel Gas Cell, 115 V
163-32XX-30	10 m Heated Stainless Steel Gas Cell, 230 V
163-41XX	10 m Heated Glass Gas Cell, 115 V
163-41XX-30	10 m Heated Glass Gas Cell, 230 V
163-46XX	1–16v Heated Glass Gas Cell, 115 V
163-46XX-30	1–16v Heated Glass Gas Cell, 230 V
163-43XX	20 m Heated Glass Gas Cell, 115 V
163-43XX-30	20 m Heated Glass Gas Cell, 230 V
163-33XX	20 m Heated Stainless Steel Gas Cell, 115 V
163-33XX-30	20 m Heated Stainless Steel Gas Cell, 230 V

Notes: Replace **XX** with your spectrometer's Instrument Code. [Click for List >](#) Metal Gas Cell bodies are made of nickel-plated aluminum. Heated Long-Path Gas Cells include KBr window(s) and Swagelok™ valves with barb fittings. Compression fittings are available upon request; specify size. Additional window materials can be ordered from the table below. Heated Long-Path Gas Cells include a digital temperature controller and heating jacket. Contact PIKE Technologies for configurations using PC control temperature module including PIKE Technologies' TempPRO software. Heated Long-Path Gas Cells may be heated to 200 °C.

REPLACEMENT WINDOWS

PART NUMBER		DESCRIPTION
25 x 4 mm	37.5 x 4 mm	
160-1217	160-1281	BaF ₂
160-1211	160-1287	CaF ₂
160-1133	160-1288	KBr
160-1178	160-1289	KCl
160-1127	-----	KRS-5
160-1124	160-1290	NaCl
160-1114	160-1291	ZnSe
160-1110	160-1286	ZnSe, Anti-Reflective Coating 1-Side
160-1109	-----	ZnSe, Anti-Reflective Coating 2-Sides

Transmission Sampling Techniques – *Theory and Applications*

FTIR sampling by transmission is a very popular method for collection of infrared spectra. Its use is easy to explain – the methods are intuitive and do not require sophisticated sampling accessories. In many cases, the sample can be placed directly into the path of the infrared beam (with the help of sample holder) and scanned. Further benefits of transmission sampling techniques include compatibility with automated sampling and microsampling techniques such as IR Microscopy.

Transmission techniques are well documented and have been successfully used for many years. A large number of spectral libraries contain transmission spectra and are often used as references for the purpose of qualitative analysis. Transmission techniques offer many advantages and should be used whenever possible, unless reliable sample preparation becomes too difficult, too time consuming or impossible. Transmission is also widely used for quantitative applications, as significant numbers of basic measurements adhere to the Beer-Lambert law. The law provides a mathematical relationship between the infrared radiation absorbed by the sample and the sample concentration:

$$A = a \cdot b \cdot c$$

Where

A = absorbance

a = absorptivity

b = pathlength

c = sample concentration

The Beer-Lambert law states that absorbance is linearly proportional to sample concentration (with sample pathlength and absorptivity constant). The actual measurements are generated in percent transmittance (which is not a linear function of concentration); however, they can be converted in real time to absorbance by all modern FTIR software packages. As mentioned before, transmission measurements are intuitive and simple. Many samples are too thick to be measured directly and they have to be processed in some way before meaningful data can be collected. Some of the sample preparation techniques are time consuming and can be destructive. Liquids and pastes are generally the easiest samples to run. A large number of liquid cells and windows are available for liquid measurements. Solid samples (with the exception of thin films) require sample preparation – making a pellet (typically potassium bromide – KBr) or a mull. Gas samples require a suitable gas cell with a pathlength sufficient to detect the desired component.

Sample Preparation and Analysis

Liquids

Most liquids and dissolved solids are easy to measure by transmission. Viscous liquids or pastes can be simply pressed between two IR transparent windows and measured by FTIR.

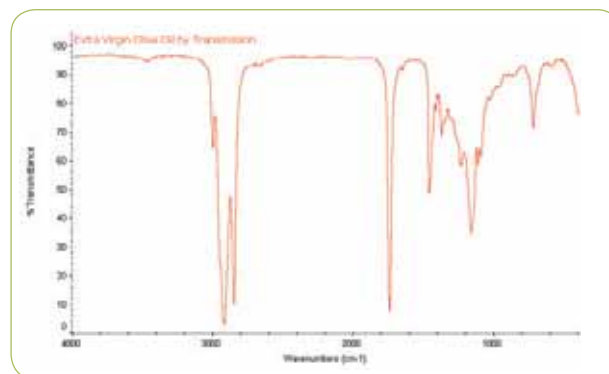

FTIR spectrum of 1 drop of extra virgin olive oil pressed between 25-mm KBr windows and held in the IR beam using the PIKE Universal Sample Holder.

Thin liquids or samples in solvent may be best run by using a demountable liquid cell or a sealed cell, consisting of two windows with a precision spacer in-between. One of the windows has two drilled holes for the introduction and evacuation of the sample. A large number of cell options are available – these include permanently sealed cells and demountable cells with different window materials and a wide selection of spacers.

The pathlength of liquid cells can be easily measured with your FTIR spectrometer. Just place the empty cell into the FTIR and collect its spectrum. The frequency of the sine wave spectrum (produced by back reflection within the cell) provides the pathlength using the following equation;

$$P = (10 \cdot N) / (2 \cdot \Delta \text{ cm}^{-1})$$

Where

P = pathlength of cell in mm

N = number of fringes within $\Delta \text{ cm}^{-1}$

$\Delta \text{ cm}^{-1}$ = wavenumber difference of fringe count

It is very important to select compatible IR transparent windows for your liquid samples. Please refer to the table on the last page of this note to select your windows. If you still have questions, please call us.

Solids

The easiest to analyze are film and polymer samples less than 200 micrometers thick (ideal thickness for the major component of a polymer film is about 20 microns). These samples can be simply placed into a sample holder and immediately scanned.

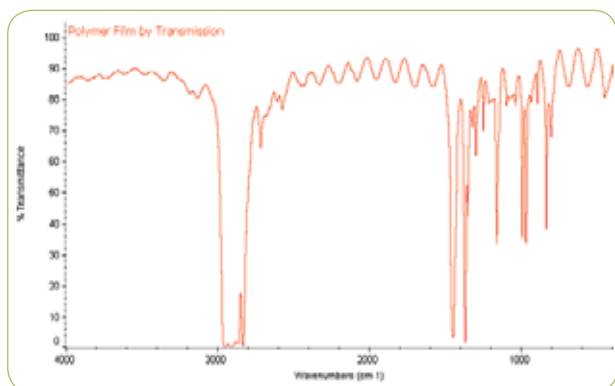

Polymer film from product packaging material – held in place with the PIKE Universal Sample Holder. Polymer is identified as Atactic Polypropylene and the film is determined to be 27.1 microns thick.

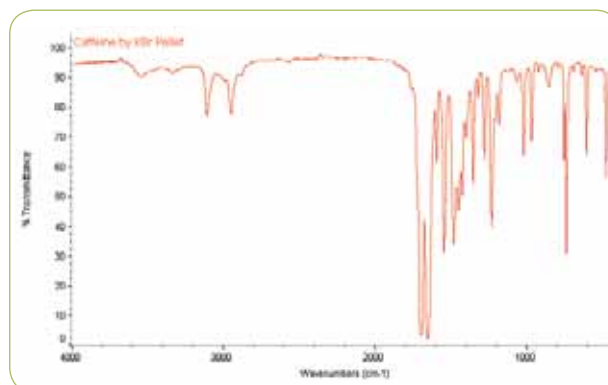

FTIR spectrum of caffeine prepared as a 13-mm KBr Pellet and held in position with the PIKE Sampling Card.

The thickness of the polymer film can be calculated from the fringe pattern in the spectrum using the following equation:

$$T = (10000 \cdot N) / (2 \cdot n \cdot \Delta \text{ cm}^{-1})$$

Where

- T = thickness of polymer film in microns
- N = number of fringes within $\Delta \text{ cm}^{-1}$
- $\Delta \text{ cm}^{-1}$ = wavenumber difference of fringe count
- n = refractive index of polymer

The same procedure can be used for samples which can be sliced and pressed to an appropriate thickness – especially for IR microsampling. PIKE Technologies' Heated Platens Accessory is ideal for making thin polymer films.

For IR microsampling, one can place a small sliced sample into a sample compression cell and apply pressure to hold the sample and to thin it to a useable thickness – as shown in the following spectral data.

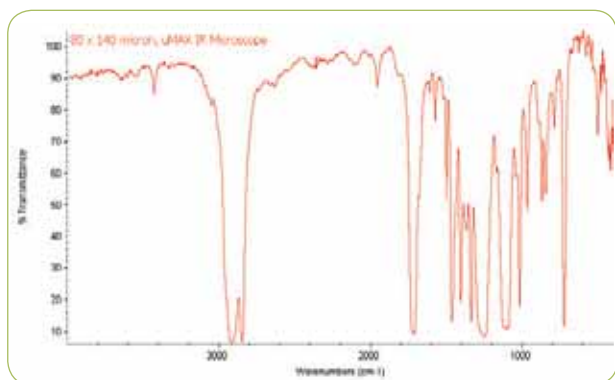

Micro spectrum of a layered polymer using a PIKE μ MAX IR Microscope and Compression Cell with KBr windows.

However, the majority of solid materials must be prepared before their infrared spectra can be collected. In many cases sample preparation involves grinding of the sample and mixing it with an IR transparent material such as KBr and then pressing a pellet. While this method of solids analysis is time consuming, it produces an excellent result.

Solid Sample Preparation Tips

The best method for preparation of solid samples involves mixing the sample (about 5% by weight) with an IR transparent material (typically KBr) and pressing a pellet. The mixing is best done with the ShakIR accessory which produces a fully mixed and pulverized sample in about 20 seconds. The grinding and mixing can also be done with a mortar and pestle – but not as well. Generation of a pellet involves pressing the prepared mixture with a hydraulic or hand press into a hard disk. The pellet, ideally 0.5 to 1 mm thick is then placed in a transmission holder and scanned. Typically, the pellet technique provides good quality spectra with a wide spectral range and no interfering absorbance bands.

Samples which do not grind well and/or are affected by solvents and mulling agents can be analyzed with high-pressure techniques. Typical samples include fibers and paint chips. The accessory used for such applications utilizes two diamond anvils. Difficult samples are placed between the diamonds and crushed, compressed and flattened to the thickness necessary to obtain good-quality FTIR spectra. Diamond cells are transparent to IR radiation except in the region of 2400 cm^{-1} to 1700 cm^{-1} . The high-pressure diamond cells require the use of a beam condenser or an infrared microscope.

An alternate method for analysis of solid materials involves making a mull. Mulls are sample suspensions in Nujol (refined mineral oil) or Fluorolube (perfluorohydrocarbon). The process is based upon mixing 1 to 2 drops of the mulling agent with a ground sample until a uniform paste is formed. The paste is transferred onto a KBr or other IR transparent disk, placed in the sample compartment of the spectrometer and scanned. The advantage of this technique is that it is a relatively quick and simple procedure; disadvantages include interference from mulling agent absorption bands. Both Nujol and Fluorolube have characteristic spectral features and in most cases have to be used as a pair in order to generate a complete mid IR spectrum. Nujol is used below 1330 cm^{-1} , Fluorolube above 1330 cm^{-1} . Some sample preparation is needed and the quality of the results and amenability to automation and microsampling offer significant advantages.

Gases

Analysis of gas samples is a unique form of transmission sampling by FTIR as the identified sample does not need to be of pure composition. At high spectral resolution, most gas mixtures can be identified and quantified since absorbance bands can be selected within the spectrum, which are resolved and distinct from other components within the sample.

Simple demountable cells (50 mm to 100 mm) are recommended for samples in a 1–10% by weight concentration range.

For highly dilute samples (ppm to ppb concentrations), long-path cells are required. The long-path cell reflects the IR beam several times through the sample using a set of mirrors positioned on the opposite ends of the cell, producing a pathlength from 2.4 to 30 meters – or more. It is important to select window materials compatible with the investigated sample. Gas sampling accessories can be fitted with different windows to accommodate the physical and chemical characteristics of the measured gas. Some gas measurement applications require temperature control for higher precision or to prevent condensation of specific components. Special designs for high-pressure and temperature controlled experiments are also available.

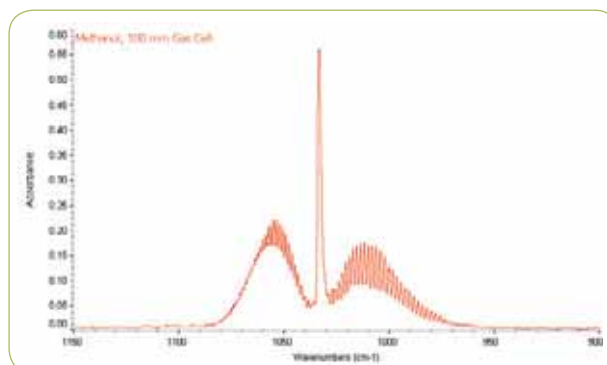

FTIR Spectrum of Methanol Vapor measured with the PIKE 100-mm gas cell using 0.50 cm⁻¹ spectral resolution.

Summary

Transmission sampling by FTIR provides an excellent means for sample identification and quantification of sample components. Most samples measured by transmission techniques require some sample preparation; however, the quality of the results and amenability to automation and microsampling offer significant advantages.

Properties of Select Infrared Transmitting Materials For Transmission Spectroscopy

Material	Comments	SWL cm ⁻¹	LWL cm ⁻¹	RI	Solubility g/100 g	Hardness kgf/mm ²	MP °C	pH Range
AMTIR	GeAsSe glass, brittle	11000	593	2.50	0.00	170	370	1–9
BaF₂	Barium Fluoride	66600	691	1.45	0.17	82	1280	5–8
CaF₂	Calcium Fluoride	79500	896	1.40	0.0017	158	1360	5–8
CsI	Cesium Iodide, very hygroscopic, Somewhat Toxic	42000	172	1.73	44	20	621	NA
Diamond	Type IIa, strong IR absorbance between 2700–1800 cm ⁻¹ , costly	30000	<2	2.40	0.00	5700	550 flash point	1–14
Ge	Germanium, brittle, becomes opaque at elevated temperatures	5500	432	4.00	0.00	780	936	1–14
KBr	Potassium Bromide, most widely used for mid-IR applications	48800	345	1.52	53	6	730	NA
KRS-5	Thallium Bromide/Thallium Iodide, Extremely Toxic!	17900	204	2.37	0.05	40	414	5–8
NaCl	Sodium Chloride	52600	457	1.49	36	18	801	NA
Polyethylene	For Far-IR, swells with some organic solvents	625	<4	1.52	0.00		110	1.5–14
SiO₂	Silicon Dioxide	50000	2315	1.53	0.00	460	1713	1–14
Si	Silicon, strong IR absorbance between 624–590 cm ⁻¹	8900	624, 30	3.41	0.00	1150	1420	1–12
ZnS	Zinc Sulfide	17000	690	2.20	0.00	240	1830	5–9
ZnSe	Zinc Selenide	15000	461	2.40	0.00	120	1526	5–9

Notes: The above table is meant to be a general guide – brief and concise. For more information about these materials, consult appropriate reference books and Safety Data Sheets (SDS).

SWL – Shortest wavelength for transmission, 1 mm, 50% transmission

LWL – Longest wavelength for transmission, 1 mm, 50% transmission

RI – Refractive index, at relevant wavelength

MP – Melting point

SPECIAL APPLICATIONS

PIKE Technologies offers several FTIR accessories specially designed for use in a dedicated sampling environment. Our semiconductor sampling accessories highlight our dedication to providing tools to ease and streamline FTIR sampling technology. If you have special sampling needs not shown in our catalog, please contact us – we may be able to help.

Vertical Wafer Accessory [Page 130](#)
Analysis of semiconductor wafers

MappIR™ [Page 131](#)
*Fully automated analysis
of 200-mm semiconductor wafers*

MAP300™ [Page 131](#)
*Fully automated analysis
of 300-mm semiconductor wafers*

TGA/FTIR Accessory [Page 133](#)
*Identification and quantification of evolved gases
from thermogravimetric analyzer*

GC-FTIR Accessory [Page 135](#)
*Identification of components separated
in GC experiment*

External Sample Module [Page 136](#)
*Auxiliary sample compartment for added flexibility
and custom applications*

**THEORY AND
APPLICATIONS**
[Page 137](#)



Vertical Wafer Accessory – For Analysis of Semiconductor Wafers

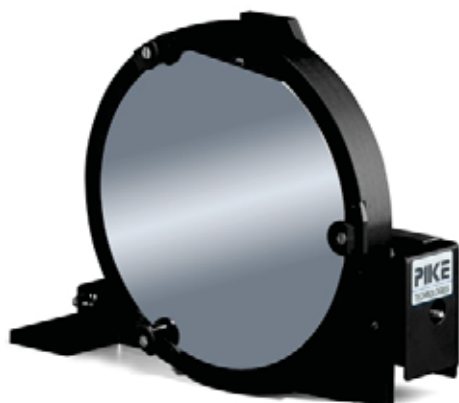

FEATURES

- Transmission analysis of semiconductor wafers for carbon, oxygen and BPSG
- Manual and/or fully-automated operation
- R-theta (rotation/translation) motion control providing complete wafer analysis
- Contamination-free wafer mount
- 6", 5", 4", 3" and 2" wafer sizes
- Custom mounts and blanks

PIKE Technologies offers the Vertical Wafer Accessory for analysis of semiconductor wafers. The Vertical Wafer Accessory is an in-compartment tool for transmission analysis of semiconductor wafers for carbon, oxygen and BPSG. The accessory accommodates wafers up to 6 inches (150 mm) in diameter. Wafers are secured in a demountable ring. Dimensional tolerances conform to SEMI standards. Delrin (hard polymer) mounting clips eliminate contact between the wafer and metal surfaces during the analysis. The clip mechanism facilitates convenient and repeatable wafer placement.

The wafer support ring may be rotated through 360° and translated laterally through a distance of over 3" (75 mm) to produce an R-theta motion covering the entire surface of the wafer. The ring may be rotated and translated manually or automatically under stepper motor control using PIKE Technologies AutoPRO software.

The automated system incorporates two precision stepper motors for rotation and translation of the plate. The motors are driven by the Motion Control Unit connected to a PC via USB. The operation is managed by PIKE AutoPRO software which provides full user programmability and an easy-to-learn "point-and-click" environment. Polar or Cartesian (X, Y) coordinates may also be used to define test points. The AutoPRO software allows complex test sequences to be set up, stored as methods and implemented with full flexibility. The Motion Control Unit features a smart power supply and operates at 85–265 VAC, 47–63 Hz. The data collection feature of AutoPRO is compatible with most FTIR software packages.

The PIKE Technologies Vertical Wafer Accessory requires minimum 3.5" beam height FTIR spectrometers. Please contact us for more product details.

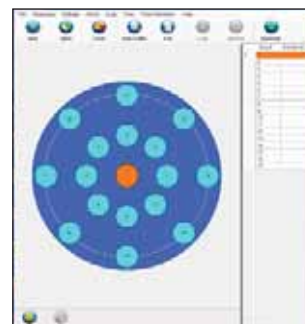

ORDERING INFORMATION

PART NUMBER	DESCRIPTION
073-26XX	Vertical Wafer Accessory, Automated Version <i>Includes motion control unit and AutoPRO software</i>
073-16XX	Vertical Wafer Accessory, Manual Version <i>Includes baseplate mount for your FTIR</i>

Notes: Replace XX with your spectrometer's Instrument Code. [Click for List >](#)
Requires 3.5" beam height or greater in FTIR.

OPTIONS

PART NUMBER	DESCRIPTION
073-3600	6" Wafer Mount, blank
073-3660	Additional Wafer Mount
073-3650	Insert to support 5" wafer
073-3640	Insert to support 4" wafer
073-3630	Insert to support 3" wafer
073-3620	Insert to support 2" wafer

Note: Contact PIKE Technologies for custom plates or options not described here.

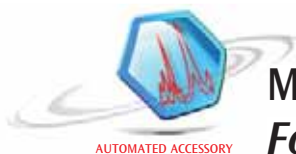

MappIR and MAP300 – For Automated Analysis of Semiconductor Wafers

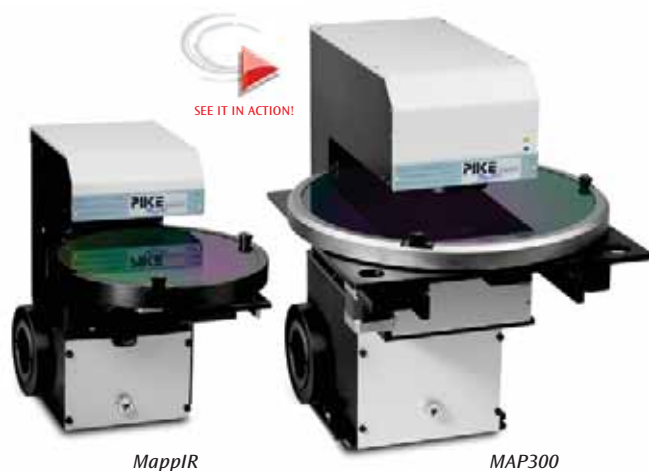

To minimize interferences of water vapor and carbon dioxide with infrared measurements, the optical path of the accessories is equipped with purging lines and can be purged with dry air or nitrogen. A wafer purge enclosure is offered as an option.

The accessories are controlled by AutoPRO software which provides a simple user interface for multiple point wafer analysis (mapping). Up to 320 points with 8-mm beam and 5-mm edge exclusion can be measured on a 12-inch wafer. The software provides ample flexibility in setting up various experiments.

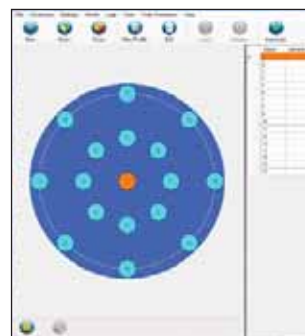

FEATURES

- Complete hardware and software package for automated, multi-position measurements and mapping of semiconductor wafers
- 8-inch (200-mm) and 12-inch (300-mm) semiconductor wafer handling.
- Optional inserts for wafer sizes from 2 to 12 inches
- EPI, BPSG, oxygen and carbon determination
- Specular reflectance and transmission sampling – standard
- Purgeable accessory for removal of atmospheric interferences
- USB controller interface

PIKE Technologies offers fully automated accessories for the analysis of semiconductor wafers. Our MappIR and MAP300 accessories provide for analysis of EPI, BPSG, oxygen and carbon in wafer sizes ranging from 2 to 12 inches (50 to 300 mm).

The MappIR and MAP300 have been developed to provide the semiconductor industry with affordable, automated tools for research and quality control of silicon wafers. The MappIR was developed for the analysis of 8-inch (200-mm) and smaller semiconductor wafers. The MAP300 is a larger version of this original design and it is capable of handling 12-inch (300-mm) wafer formats. The operation, electronics and software are identical for both systems.

The MappIR and MAP300 accessories mount in the sample compartment of the FTIR spectrometer. Semiconductor wafers are held in place by spring-loaded Delrin retaining clips and are never in contact with the aluminum stage of the accessory. A standard size slot for a vacuum or mechanical wand is provided for ease of wafer handling. Individual wafers are rotated and/or translated by stepper motors in a sequence pre-programmed by the system operator.

Advantages of the AutoPRO Package

- Graphical and intelligent user interface for setting up mapping patterns
- Selection of wafer size, IR beam diameter and edge exclusion
- Operator-selectable or pre-defined multiple point maps
- Polar and/or Cartesian coordinates options
- Real-time display of the experiment status
- Ability to save and recall various experimental patterns
- COM-enabled interface for use with macros/scripting
- KLA and CSV file importer

Data collection and processing is provided by the spectrometer software. A number of FTIR manufacturers offer dedicated packages which fully integrate the accessory with the spectrometer. If such an option is not available, AutoPRO can be controlled by the spectrometer's program via macros. AutoPRO is Windows compliant and when run separately, it allows configuration, programming and control of the accessory.

PIKE automated wafer accessories are compatible with most commercial FTIR spectrometers and software packages.

ORDERING INFORMATION

MAPPiR AND MAP300 AUTOMATED SEMICONDUCTOR WAFER ACCESSORIES

PART NUMBER	DESCRIPTION
016-28XX	MappiR Accessory for 8" Wafers <i>Includes wafer mount, motion control unit, AutoPRO software and mount for your FTIR</i>
016-29XX	Purge-Ready MappiR Wafer Accessory for 8" Wafers <i>Includes wafer mount, motion control unit, AutoPRO software and mount for your FTIR (order purge enclosure separately)</i>
017-28XX	MAP300 Accessory for 12" Wafers <i>Includes wafer mount, motion control unit, AutoPRO software, mount for your FTIR and insert to support 8" wafers</i>

Notes: Replace **XX** with your spectrometer's Instrument Code. [Click for List >](#)
P/N 017-28XX is purge enclosure ready. Order optional purge enclosure separately.



Optional purge enclosure mounted on 8" MappiR accessory

OPTIONS FOR THE MAPPiR AND MAP300 ACCESSORIES

PART NUMBER	DESCRIPTION
073-3880	Additional 8" Wafer Mount (MappiR only)
073-3800	Blank Support – for custom wafers (MappiR only)
017-3912	Additional 12" Wafer Mount (MAP300 only)
017-3980	Insert to Support 8" Wafer (MAP300 only)
073-3860	Insert to Support 6" Wafer
073-3850	Insert to Support 5" Wafer
073-3840	Insert to Support 4" Wafer
073-3830	Insert to Support 3" Wafer
073-3820	Insert to Support 2" Wafer
016-3000	Purge Enclosure for MappiR
017-3000	Purge Enclosure for MAP300

Notes: **Purge enclosure will not fit with all spectrometer types.** For more options or additional information, contact PIKE Technologies.

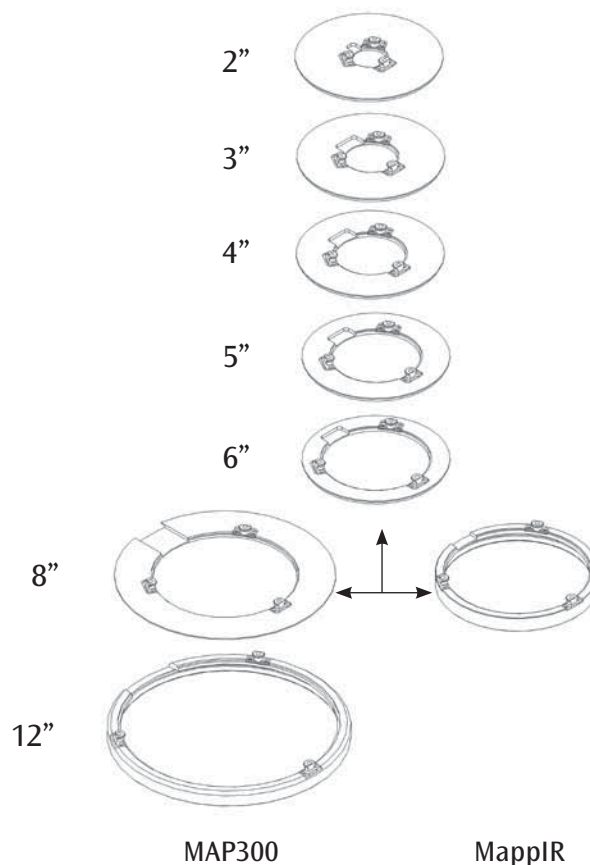

TGA/FTIR Accessory – Identification and Quantification of Evolved Gases from Thermogravimetric Analyzer



FEATURES

- Gas cell design conforming to IR beam geometry – maximizes IR throughput with minimum cell volume
- 100-mm IR beam pathlength for maximized FTIR sensitivity
- Baseplate-mounted in your FTIR for flexible sampling
- Temperature control settable up to 300 °C for flow cell and transfer line
- User-changeable IR transparent windows to minimize cost of operation
- Heated, glass-lined stainless steel transfer line for inert transfer of TGA effluent

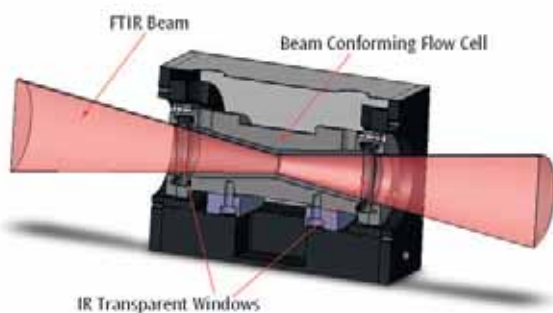

IR beam conforming optical design of PIKE Technologies TGA/FTIR Accessory.

The PIKE Technologies TGA/FTIR Accessory is designed to be an interface for evolved gas analysis from a thermogravimetric analyzer (TGA) to your FTIR spectrometer. Evolved gases from the TGA pass through a heated transfer line into the beam conforming flow cell in the FTIR sample compartment. As these evolved gases travel through the flow cell, FTIR spectra are collected and stored for further processing. Qualitative and quantitative measurements are doable from sample masses – typically in the low milligram range. The PIKE TGA/FTIR Accessory is compatible with most FTIR spectrometers and most TGA instruments.

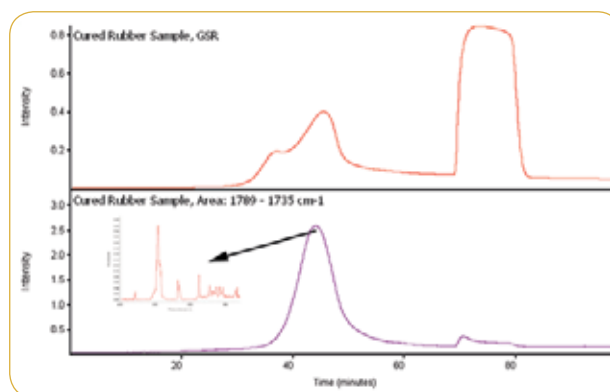

TGA/FTIR data for cured rubber sample. Upper trace is the Gram-Schmidt reconstruct of the TGA evolved gases. Lower trace is a carbonyl reconstruction and an FTIR spectrum from this data set.

During the TGA analysis sample mass is lost through a combination of volatilization and degradation of the sample material. The heated TGA/FTIR system maintains the vapor state of the evolved gases throughout the FTIR analysis. Typical samples include polymers, epoxies, fibers and laminates for investigating deformation, thermal stability or comparative study applications.

Typically, the FTIR spectrometer is set to collect spectra at 10-second intervals during the evolved gas analysis using the kinetics software package for your FTIR. With this software you can generate reconstructions of total IR response versus time or temperature (Gram-Schmidt) or specific IR band reconstructions to isolate points of unique component evolutions. FTIR spectra are extracted from the data set and an identification is made by comparing these unknown spectra to vapor phase spectral libraries.

SPECIFICATIONS

Temperature Range	Ambient to 300 °C
Accuracy	+/- 0.5% of set point
Voltage	24 VAC
Sensor Type	3 wire Pt RTD (low drift, high stability)
Controllers	
Input Voltage	115/230 V, switchable
Output Voltage	10 A/24 VAC
Dimensions (W x D x H)	91 x 140 x 121 mm (excludes baseplate mount)

ORDERING INFORMATION

TGA/FTIR ACCESSORY FLOW CELL

PART NUMBER DESCRIPTION

162-24XX	TGA/FTIR Accessory Flow Cell <i>Includes mount for your FTIR, exhaust line and high-temperature O-rings</i>
----------	--

Notes: Replace **XX** with your spectrometer's Instrument Code. [Click for List >](#)
Complete accessory requires selection of IR transparent windows, heated transfer line and temperature controller. The TGA/FTIR accessory requires installation by a trained service representative – please consult with your FTIR manufacturer.

IR TRANSPARENT WINDOWS FOR TGA/FTIR ACCESSORY

(must select 2 or more)

PART NUMBER DESCRIPTION

160-1320	Window, KBr, 38 x 6 mm
160-1329	Window, ZnSe, 38 x 6 mm

Note: For window compatibility please consult our Materials Properties table on page 128 of this catalog.

HEATED TRANSFER LINE FOR TGA/FTIR ACCESSORY

(must select one)

PART NUMBER DESCRIPTION

115-0001	Heated Transfer Line for Shimadzu TGA50 <i>Includes evolved gas port modifications</i>
115-0005	Heated Transfer Line for Mettler 851 TGA
115-0006	Heated Transfer Line for Mettler 851e/LF or TGA-DSC1/2/3 TGA
115-0007	Heated Transfer Line for TA Instruments Q600 TGA
115-0008	Heated Transfer Line for TA Instruments Discovery/Q5000R
115-0009	Heated Transfer Line for TA Instruments Q50/Q500 TGA
115-0010	Heated Transfer Line for TA Instruments 2050/2950
115-0011	Heated Transfer Line for Netzsch TGA
115-0012	Heated Transfer Line for PESTA6/4000 110V TGA
115-0013	Heated Transfer Line for SETARAM
115-0014	Heated Transfer Line for PESTA6/4000 220V TGA
115-0017	TGA Universal Transfer Line <i>Includes the following adapters; 1/8" to 1/8" union, 1/4" to 1/8" reducing union, 3-mm to 1/8" union, 6-mm to 1/8" reducing union and 6-mm PTFE ferrules</i>
115-0018	PTFE TGA Transfer Line, 230 °C max. <i>Recommended for TGAs with evolved gas ports made of ceramic or moving furnace heads</i>

Notes: We will need to know the make and model number of your TGA. Please consult your TGA supplier to ensure compatibility with evolved gas analysis. Contact PIKE Technologies about interfacing to other TGA instruments. Unless noted otherwise, all PIKE transfer lines are 1/8" OD, silica-lined stainless steel, 48" in length and offers a maximum temperature of 300 °C .

TEMPERATURE CONTROLLERS FOR TGA/FTIR ACCESSORY

(must select one)

PART NUMBER DESCRIPTION

076-1120	Dual Digital Temperature Control Module
076-1130	4-Zone Digital Temperature Control Module for Shimadzu TGA

Note: These temperature controllers provide setting for the heated gas cell and the heated transfer line.

REPLACEMENT PARTS AND OPTIONS

PART NUMBER DESCRIPTION

162-2309	High-Temperature O-Rings, max temp 325 °C, (1 ea.)
162-2308	High-Temperature O-Rings, max temp 325 °C, (4 ea.)

Note: Gas cell requires 4 O-rings. For high-temperature purge tubes and other options, please contact PIKE Technologies.

GC-FTIR Accessory – Combining GC Separation with Identification Power of FTIR

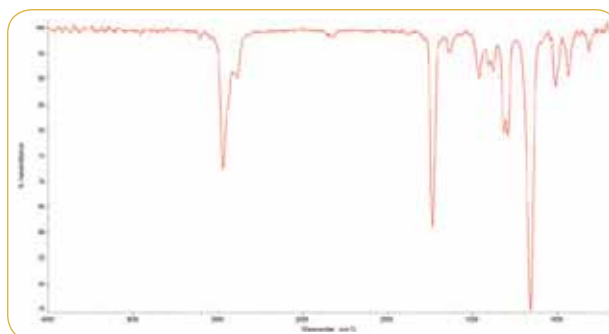

GC-FTIR data for IBMA.

FEATURES

- Isomer identification
- Secondary confirmation of GC-MS results
- 120-mm IR beam pathlength for maximized FTIR sensitivity
- Temperature control settable up to 300 °C for flow cell and transfer line
- Purgeable module

The PIKE Technologies GC-FTIR Accessory is an interface between the GC and the FTIR instruments. When fully installed, the sample pathway from the end of the GC column is diverted to a heated gas cell and back to the GC detector through the use of temperature controlled transfer lines. To maximize sensitivity, the light pipe is gold-coated and the accessory includes an on-board MCT detector.

Coupling gas chromatography with infrared spectroscopy provides an effective method of separating compounds as the

sample moves through the GC column and identifying these compounds by spectroscopy. GC-FTIR is a preferred method for identifying isomers, which may be incorrectly identified using GC-MS. In addition, GC-FTIR may be used as a complementary analytical technique to confirm GC-MS results. Typical applications of GC-FTIR include the analysis of drugs, fragrances, and other organic compounds found in mixtures.

SPECIFICATIONS

Dimensions (W x D x H)	51 x 45 x 27 cm
Weight	16 kg
FTIR Placement	Right or Left Side
Beam Height	Specific for FTIR
Detector Options	Yes
Purge	Purgeable
Light Pipe Diameter	1 mm
Light Pipe Pathlength	120 mm
Maximum Temperature	300 °C

ORDERING INFORMATION

GC-FTIR BASE ACCESSORY (must select external beam direction)

PART NUMBER	DESCRIPTION
140-10XXR	GC-FTIR Accessory, Right Side
140-10XXL	GC-FTIR Accessory, Left Side

Notes: Replace **XX** with your spectrometer's Instrument Code. [Click for List >](#) GC-FTIR Accessory includes optics, mounting hardware, narrow-band MCT detector and detector electronics, heated gas cell and temperature controller. The GC-FTIR accessory requires installation by a trained service representative; please consult with your FTIR and GC manufacturer.

TRANSFER LINE FOR GC-FTIR (must select transfer line)

PART NUMBER	DESCRIPTION
115-0050	GC-FTIR Accessory Transfer Line

REPLACEMENT PARTS

PART NUMBER	DESCRIPTION
160-1135	Window, KBr, 13 x 2 mm (single)
160-1008	Window, KBr, 13 x 2 mm (6-pack)
140-2001	GC Graphite Window Gasket
140-2010	Ferrule for 0.25-mm coupling (5 ea.)
140-2015	Ferrule for 0.32-mm coupling (5 ea.)
140-2020	Ferrule for 0.53-mm coupling (5 ea.)

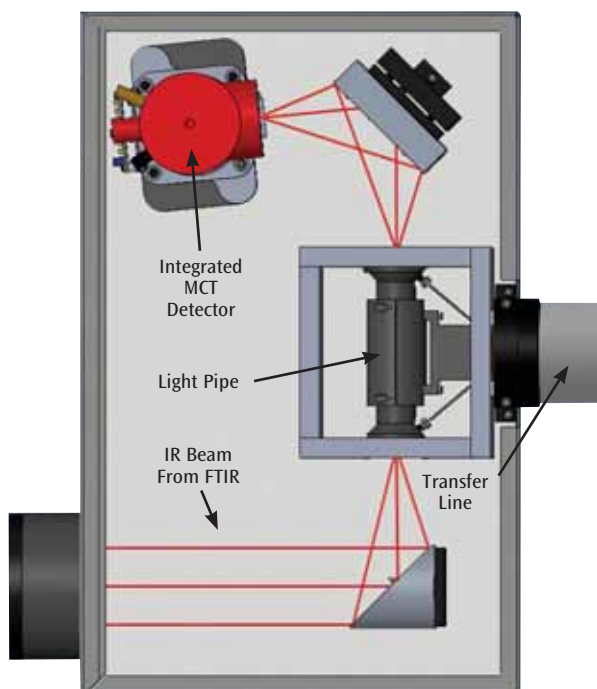

Optical geometry of the GC-FTIR Accessory.

External Sample Module – Extending Sampling Efficiency



FEATURES

- Utilizes external beam of FTIR – keeps main sample compartment free for general sampling
- Right and left external beam versions
- Full sized dimensions – for all sample compartment accessories
- Choice of integrated detector
- Ideal for heated applications or a difficult experimental setup – saving time and improving reproducibility
- Customizable configuration – removable sample compartment walls for specific optical layouts
- Vibration isolated design – providing highest spectral quality
- Compatible with most FTIR spectrometers
- 1" x 1" 1/4–20 hole grid

The External Sample Module from PIKE Technologies is a versatile sampling station for FTIR spectrometers. It provides an additional sample compartment to keep the main sample compartment of the FTIR free for routine sampling and also provides a location for a more complex sampling setup. Examples of experiments ideally suited to using the External Sample Module include a long-path gas cell, PIKE TGA/FTIR accessory, MappIR™ and the AutoDiff™ (PIKE's automated diffuse reflectance accessory). The sample compartment of the External Sample Module is full sized, and compatible with all PIKE Technologies accessories.

In addition to being a traditional sample compartment, the External Sample Module has a screw-hole grid for customized optical layouts with removable inner and outer walls.

The External Sample Module is compatible with either sealed and desiccated or purged FTIR spectrometers. It may be paired with most FTIR spectrometers with an external beam.

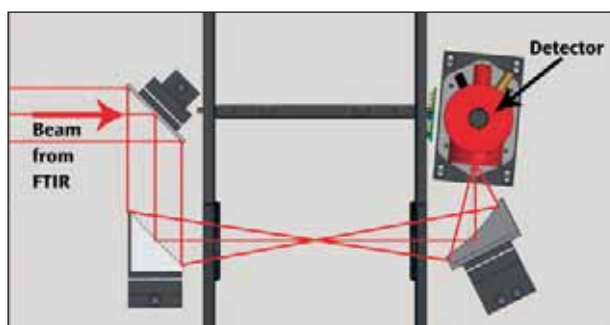

Optical geometry for right side External Sample Module

SPECIFICATIONS

Dimensions (W x D x H)	615 x 490 x 205 mm
Weight	28 kg
FTIR Placement	Right or Left Side
Beam Height	Specific for FTIR
Sample Compartment Size) (W x D x H)	190 x 265 x 155 mm
Detector Options	DTGS, MCT, others inquire
Screw Hole Grid	1" OC, 1/4-20, sealed
Sample Compartment EFL	6"
Purge	Purgeable
Inner, Outer Walls	Removable
FTIR Compatibility	Most

ORDERING INFORMATION

EXTERNAL SAMPLE MODULE (must select external beam direction)

PART NUMBER	DESCRIPTION
155-10XXR	External Sample Module, Right Side <i>Includes optics, mounting hardware, electrical cabling for FTIR, sample compartment windows, purge tubing and fittings to connect to purge gas</i>
155-10XXL	External Sample Module, Left Side <i>Includes optics, mounting hardware, electrical cabling for FTIR, sample compartment windows, purge tubing and fittings to connect to purge gas</i>

Notes: Replace **XX** with your spectrometer's Instrument Code. [Click for List >](#) FTIR must be capable of interfacing with an external detector and have optics required for the external beam. Requires installation by your FTIR spectrometer provider. A conversion kit may be required to use your sampling accessory in the sample compartment – contact PIKE Technologies.

DETECTOR FOR EXTERNAL SAMPLE MODULE

(must select one or more)

PART NUMBER	DESCRIPTION
155-2010	DLATGS Detector for External Sample Module
155-2020	MCT Detector (mid band) for External Sample Module
155-2030	MCT Detector (narrow band) for External Sample Module
155-2040	MCT Detector (wide band) for External Sample Module

Notes: Detectors for the ESM may be exchanged by the customer and are pin-mounted for easy exchange without alignment. Please ask us about other detector options.

REPLACEMENT WINDOWS

PART NUMBER	DESCRIPTION
160-1186	Window, KBr, 50 x 3 mm
160-5030	Window, BaF ₂ , 50 x 3 mm
160-1165	Window, NaCl, 50 x 3 mm

Semiconductor Applications – FTIR Sampling Techniques Overview

FTIR spectroscopy has established itself as a method of choice in several areas of industrial manufacturing. One of them is the quality control of semiconductor wafers. Here, the FTIR spectrometers are commonly used to measure Phosphosilicate glass (PSG) and Borophosphosilicate glass (BPSG) films, epitaxial film (EPI) thickness and interstitial oxygen and substitution carbon content.

Addition of boron and phosphorus to silicate glass during manufacturing improves the final product uniformity and reduces glass forming temperatures. Borophosphosilicate glass (BPSG) melts 100 °C lower than Phosphosilicate glass (PSG) and offers better flow characteristics. To maintain and optimize production processes, evaluation and verification of doping levels is required. FTIR allows simultaneous measurements of boron and phosphorus as well as the thickness of the glass in a quick and nondestructive procedure. The measurements are based on the interpretation of transmission spectra and quantification of boron, phosphorus and Si-O bands. K-matrix or Partial Least Squares (PLS) methods are used for concentration/thickness calculations.

The epitaxial film (EPI) is a grown crystal layer having the same crystallographic orientation as the substrate crystal wafer. The epitaxial film differs from the substrate base as it is modified with various additives. Accurate, fast and precise determination of the EPI film thickness is important in the manufacturing process since film thickness and uniformity play a critical role in etching time and device yield across the wafer surface. Specular reflectance is used in FTIR measurements of the epitaxial layer thickness. The infrared beam enters the EPI layer, reflects off the substrate surface and makes another pass through the film when exiting. The film thickness calculations are based on one of the following methods:

- **Interference measurements** – also called Constant Angle Reflection Interference Spectroscopy or CARIS. This method uses the interference fringe pattern obtained in the specular reflectance experiment.
- **Interferogram subtraction** – based on the measurement of the primary and secondary interferogram of the sample and subtraction of this signal from that of the reference material.
- **Second Fourier Transform** of spectral response data (CEPSTRUM). This method takes the difference of two spectral response curves and performs a second Fourier transform which provides signal intensity versus sample thickness information.

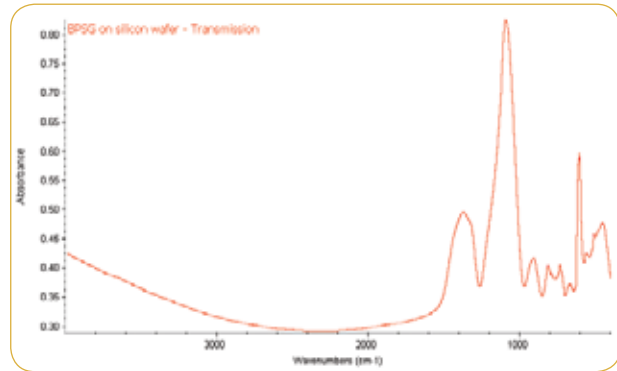

FTIR spectrum of BPSG on silicon wafer – transmission sampling mode.

Oxygen and carbon may be introduced to the molten silicon during the manufacturing process. These impurities can be trapped in the crystal lattice and affect final product characteristics. For these reasons, both need to be monitored and quantified. FTIR spectroscopy (transmission measurements) provides excellent means to perform this analysis. The application uses the absorption bands of Si-C and Si-O-Si to calculate concentration levels of substitution carbon and interstitial oxygen. Beer's law is typically used to determine their concentrations.

UV-VIS ACCESSORIES

PIKE is addressing the growing need for more sophisticated UV-Vis accessories by featuring research-style specular reflectance accessories, polarizers and automated sampling stages. We also include a selection of most commonly used UV-Vis cuvettes and cuvette holders. Please contact us to discuss customized options.

UV-Vis Cuvettes, Cells, Vials, Holders [Page 140](#)

Peltier-Controlled Cuvette Holders [Page 142](#)
For Experiments Under Tightly Controlled Temperature Conditions

Falcon UV-Vis [Page 144](#)
Precise Cell Temperature Control Accessory

UV-Vis DiffusIR™ [Page 145](#)
Diffuse Reflectance Accessory

UV-Vis Polarizers [Page 147](#)
Manual and Automated

UV-Vis Spec [Page 149](#)
Slide Mounted Specular Reflectance Accessories

UV-Vis 10Spec and 85Spec [Page 150](#)
Fixed Angle Specular Reflectance Accessories

UV-Vis VeeMAX™ [Page 152](#)
Variable Angle Specular Reflectance Accessory

Microplate Reader [Page 153](#)
Out-of-compartment plate reading

Automated R-Theta Stages [Page 154](#)
For UV-Vis Spectrophotometers

UV-Vis Cuvettes, Cells, Vials and Holders

PIKE Technologies offers a selection of the most popular cuvettes, vials and cell holders used in the field of UV-Vis spectrophotometry. The cuvettes are manufactured using a heat fusing method which ensures that they are fused into a single homogeneous unit. Cuvettes are carefully annealed to remove any residual strain for maximum cell integrity and physical strength.

The cells can be used with most solvents and acidic solutions. Hydrofluoric acid (HF) and strong bases (pH >9) will negatively affect the cell surfaces.

SPECIFICATIONS	
Window Thickness	1.25 mm
Beam Height (Z-dimension)	8.5 mm and 11 mm
Optical Glass Spectral Range	334 to 2500 nm
Far UV Quartz Spectral Range	170 to 2700 nm
NIR Quartz Spectral Range	220 to 3800 nm

ORDERING INFORMATION

STANDARD RECTANGULAR CUVETTES

PATHLENGTH mm	VOLUME mL	OPTICAL GLASS (334–2500 nm)		FAR UV QUARTZ (170–2700 nm)		NIR QUARTZ (220–3800 nm)	
		With PTFE Cover Part Number	With PTFE Stopper Part Number	With PTFE Cover Part Number	With PTFE Stopper Part Number	With PTFE Cover Part Number	With PTFE Stopper Part Number
1	0.40	162-0220	162-0228	162-0236	162-0244	162-0252	162-0260
2	0.70	162-0221	162-0229	162-0237	162-0245	162-0253	162-0261
5	1.70	162-0222	162-0230	162-0238	162-0246	162-0254	162-0262
10	3.50	162-0223	162-0231	162-0239	162-0247	162-0255	162-0263
20	7.00	162-0224	162-0232	162-0240	162-0248	162-0256	162-0264
40	14.00	162-0225	162-0233	162-0241	162-0249	162-0257	162-0265
50	17.50	162-0226	162-0234	162-0242	162-0250	162-0258	162-0266
100	35.00	162-0227	162-0235	162-0243	162-0251	162-0259	162-0267

SEMI-MICRO RECTANGULAR CUVETTES – 4-mm OPENING

PATHLENGTH mm	VOLUME mL	WITH PTFE COVER/CLEAR PART NUMBER	WITH PTFE COVER/BLACK WALLED PART NUMBER	WITH PTFE STOPPER/CLEAR PART NUMBER	WITH PTFE STOPPER/BLACK WALLED PART NUMBER
OPTICAL GLASS (320–2500 nm)					
5	0.70	162-0268	162-0273	162-0278	162-0283
10	1.40	162-0269	162-0274	162-0279	162-0284
20	2.80	162-0270	162-0275	162-0280	162-0285
40	5.60	162-0271	162-0276	162-0281	162-0286
50	7.00	162-0272	162-0277	162-0282	162-0287
FAR UV QUARTZ (170–2700 nm)					
5	0.70	162-0288	162-0293	162-0298	162-0303
10	1.40	162-0289	162-0294	162-0299	162-0304
20	2.80	162-0290	162-0295	162-0300	162-0305
40	5.60	162-0291	162-0296	162-0301	162-0306
50	7.00	162-0292	162-0297	162-0302	162-0307

MICRO RECTANGULAR CUVETTES – 2-mm OPENING

PATHLENGTH mm	VOLUME mL	WITH PTFE COVER/CLEAR PART NUMBER	WITH PTFE COVER/BLACK WALLED PART NUMBER	WITH PTFE STOPPER/CLEAR PART NUMBER	WITH PTFE STOPPER/BLACK WALLED PART NUMBER
OPTICAL GLASS (320–2500 nm)					
5	0.35	162-0308	162-0313	162-0318	162-0323
10	0.70	162-0309	162-0314	162-0319	162-0324
20	1.40	162-0310	162-0315	162-0320	162-0325
40	2.80	162-0311	162-0316	162-0321	162-0326
50	3.50	162-0312	162-0317	162-0322	162-0327
FAR UV QUARTZ (170–2700 nm)					
5	0.35	162-0328	162-0333	162-0338	162-0343
10	0.70	162-0329	162-0334	162-0339	162-0344
20	1.40	162-0330	162-0335	162-0340	162-0345
40	2.80	162-0331	162-0336	162-0341	162-0346
50	3.50	162-0332	162-0337	162-0342	162-0347

ORDERING INFORMATION

CYLINDRICAL CELLS WITH TEFLON STOPPERS –22-mm DIAMETER

PATHLENGTH mm	VOLUME mL	OPTICAL GLASS (334–2500 nm)	FAR UV QUARTZ (170–2700 nm)	NIR QUARTZ (220–3800 nm)
10	2.80	162-1831	162-1841	162-1801
20	5.60	162-1832	162-1842	162-1802
50	14.10	162-1835	162-1845	162-1805
100	28.20	162-1840	162-1850	162-1810

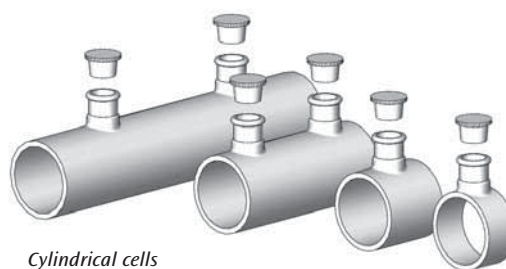

Cylindrical cells

VIALS AND DISPOSABLE CUVETTES

PART NUMBER	DESCRIPTION
162-0205	5-mm Disposable Glass Vials, 5 x 42 mm (200 ea.)
162-0208	8-mm Glass Vials, 8 x 43 mm (200 ea.)
162-0212	12-mm Glass Vials, 12 x 32 mm (200 ea.)
162-0348	Polystyrene, Disposable Cuvettes, 10-mm pathlength, 4.5 mL (100 ea.)
162-0349	Polystyrene, Semi-micro Disposable Cuvettes, 10-mm pathlength, 1.5 mL (100 ea.)

CELL HOLDERS, SPACERS AND STOPPERS

PART NUMBER	DESCRIPTION
111-3650	Cuvette Holder, 10 mm
111-3660	Adjustable Cuvette Holder, 10–100 mm
161-2530	Slide Sample Holder, Cylindrical Cell, 10–20 mm
161-2540	Slide Sample Holder, Cylindrical Cell, 50 mm
161-2550	Slide Sample Holder, Cylindrical Cell, 100 mm
162-1201	Spacer for 1-mm pathlength cuvette
162-1202	Spacer for 2-mm pathlength cuvette
162-1205	Spacer for 5-mm pathlength cuvette
162-3685	Vial Holder, 5 mm
162-3688	Vial Holder, 8 mm
162-3682	Vial Holder, 12 mm

Notes: Please contact PIKE Technologies for replacement Teflon stoppers, covers, and for items not described on this list.

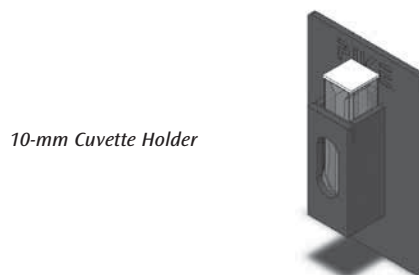

10-mm Cuvette Holder

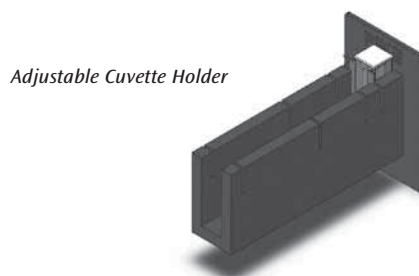

Adjustable Cuvette Holder

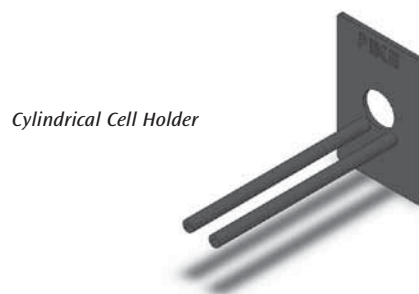

Cylindrical Cell Holder



Spacers for 1-, 2- and 5-mm cells



Vial Holders for 12-, 8- and 5-mm cells

Peltier-Controlled Cuvette Holders for UV-Vis Spectrophotometers – Experiments Under Tightly Controlled Temperature Conditions



FEATURES

- Fast temperature response
- Precision temperature control
- Variable built-in magnetic stirring
- Single- and dual-beam configuration

The new series of PIKE Technologies Peltier accessories includes liquid-cooled cuvette holders, two-channel Temperature Controller and optional Liquid Recirculator. The complete PIKE Peltier Cuvette Accessory requires Peltier cuvette holders, Temperature Controller and Liquid Recirculator. With its efficient design, the Peltier Accessory offers precision temperature control and highly responsive ramping.

The cuvette holder can be used with single- and dual-beam spectrophotometers, and is offered in single or twin configurations. Each temperature-controlled cuvette holder features an efficient heat exchange design, variable speed magnetic stirrers, and a thermoelectric cooler based on Peltier principle. Liquid flow is used to remove excess heat from Peltier elements.

The Peltier cuvette holders are designed to accommodate standard size 10-mm pathlength cuvettes and shorter path cuvettes with appropriate spacers. The holders accommodate 8.5-mm and 15-mm beam Z-height configurations.

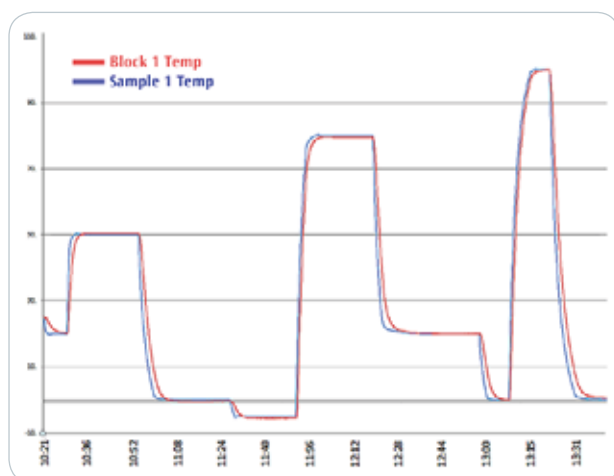

Accessory performance showing block temperature (red) and sample probe temperature (blue).

The temperature controller is configured for a single or dual channel used with the single and twin design, respectively. Within each channel, temperature may be controlled from the precision block RTD sensor or from an optional external temperature RTD probe inserted into the sample cell. All temperature controllers have a USB for PC communication and may be used with PIKE TempPRO software, which provides functions for accessory programming, setting of temperature points and ramping. Temperature controllers have a touchscreen LCD panel featuring intuitive, menu-driven programming. Single set points or simple ramping functions can be preprogrammed and performed.

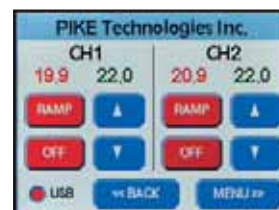

Dedicated temperature controller main menu



PIKE TempPro software for kinetic experiments

SPECIFICATIONS

Cuvette Holders	
Temperature Range	-5 °C–110 °C
Precision	+/- 0.05 °C
Temperature Accuracy	+/- 0.3 °C from -5 °C to 110 °C
RTD Probe	2 Wire Pt RTD (low drift, high stability)
Stirring Speeds	10 Steps, Variable
Cuvette Size	12.5 mm x 12.5 mm (accommodates smaller size with appropriate spacers)
Z-height	8.5 mm and 15 mm
Temperature Controller	
Precision	+/- 0.1 °C
Channels	Single or Dual
Functions	Set point, temperature ramping
Computer Interface	USB
Input Voltage	90–264 V, auto setting, external power supply
Output Voltage	15 VDC/60 W maximum
Dimensions (W x D x H)	83 x 105 x 85 mm

ORDERING INFORMATION

PART NUMBER	DESCRIPTION
171-70XXX	Peltier Cuvette Holder, single – liquid regulated
171-80XXX	Peltier Cuvette Holder, twin – liquid regulated
171-1250	Temperature Control Unit, LCD/PC, single channel
171-2250	Temperature Control Unit, LCD/PC, dual channel
171-1905	RTD Probe for Peltier cuvette
170-1100	Liquid Recirculator for Peltier cuvette
162-1905	Micro Stir Bar, 6.35 mm (l) x 3 mm (dia)

SPACERS

PART NUMBER	DESCRIPTION
162-1201	Spacer for 1-mm pathlength cuvette
162-1202	Spacer for 2-mm pathlength cuvette
162-1205	Spacer for 5-mm pathlength cuvette

Notes: Replace XXX with your spectrophotometer's Instrument Code. [Click for List >](#)
 Temperature control unit must be selected.

STANDARD RECTANGULAR CUVETTES

PATHLENGTH mm	VOLUME mL	OPTICAL GLASS (334–2500 nm)		NIR QUARTZ (220–3800 nm)	
		With PTFE Cover PART NUMBER	With PTFE Stopper PART NUMBER	With PTFE Cover PART NUMBER	With PTFE Stopper PART NUMBER
1	0.40	162-0220	162-0228	162-0252	162-0260
2	0.70	162-0221	162-0229	162-0253	162-0261
5	1.70	162-0222	162-0230	162-0254	162-0262
10	3.50	162-0223	162-0231	162-0255	162-0263
20	7.00	162-0224	162-0232	162-0256	162-0264
40	14.00	162-0225	162-0233	162-0257	162-0265
50	17.50	162-0226	162-0234	162-0258	162-0266
100	35.00	162-0227	162-0235	162-0259	162-0267

Note: Refer to page 140 for a full selection of cuvettes.

Falcon UV-Vis – Precise Cell Temperature Control Accessory



FEATURES

- Fast and easy analysis of samples under precise Peltier temperature control
- Choice of cuvette and vial adapters
- Compatible with 1-mm to 10-mm pathlength cuvettes and disposable vials
- Excellent thermal accuracy and precision
- Available for selected UV-Vis spectrophotometers

The PIKE Technologies UV-Vis cell temperature control accessory is an excellent choice for analysis of liquid samples that require precise temperature control. The accessory is well suited for pharmaceutical, life science and general industrial applications. Temperature range of the accessory is 5 °C to 130 °C with +/- 0.5% accuracy. Heating and cooling is controlled by a built-in Peltier device. The Peltier element provides for reproducible ramping and for reaching target temperatures quickly and reliably. The system is driven by a digital temperature controller – directly, or via PC. Individual sample holders are designed to accommodate standard 1-mm to 10-mm cuvettes (1-, 2- and 5-mm cuvettes require use of spacers) and 5-, 8- and 12-mm glass vials. Sample holders are pin positioned to ensure maximum reproducibility.

The complete Falcon UV-Vis configuration requires the accessory base, vial or cuvette holder, and one of the available temperature controllers. The Falcon accessory is compatible with a selected range of UV-Vis spectrophotometers.



PIKE Liquid Recirculator

ORDERING INFORMATION

PART NUMBER	DESCRIPTION
110-60XXX	Falcon UV-Vis Base <i>Includes temperature controlled base (digital temperature controller and sample holder need to be selected from the tables below for complete system)</i>

Note: Replace XXX with your spectrophotometer's Instrument Code. [Click for List >](#)

TEMPERATURE CONTROLLERS (must choose one)

PART NUMBER	DESCRIPTION
076-1230	Digital Temperature Control Module
076-1430	Digital Temperature Control Module, PC Control (USB)

SAMPLE HOLDERS (must choose at least one)

PART NUMBER	DESCRIPTION
111-3610	Vial Holder, 5 mm
111-3620	Vial Holder, 8 mm
111-3630	Vial Holder, 12 mm
111-3640	Cuvette Holder, 1 cm

Notes: Spacers for short pathlength cuvettes are designed to work only with 1-cm cuvette holder.

OPTIONS

PART NUMBER	DESCRIPTION
162-0205	Glass Vials, 5 mm, 5 x 42 mm OD (200 ea.)
162-0208	Glass Vials, 8 mm, 8 x 43 mm OD (200 ea.)
162-0212	Glass Vials, 12 mm, 12 x 32 mm OD (200 ea.)
162-0255	Falcon Quartz Cuvette, 1 cm
162-1201	Spacer for 1-mm Cuvette
162-1202	Spacer for 2-mm Cuvette
162-1205	Spacer for 5-mm Cuvette
170-1100	Liquid Recirculator

Note: Please see more cuvette options on page 140.

SPECIFICATIONS

Temperature Control	Peltier (cooling and heating)
Temperature Range	5 °C to 130 °C
Accuracy	+/- 0.5% of set point
Sensor Type	3 wire Pt RTD (low drift, high stability)
Temperature Controllers	
Digital	+/- 0.5% of set point
Digital PC	+/- 0.5% of set point, graphical setup, USB interface
Input Voltage	90–264 V, auto setting, external power supply
Output Voltage	16 VDC/150 W maximum
Dimensions (W x D x H)	89 x 121 x 83 mm (without FTIR baseplate and mount)

Notes: Peltier device must be water-cooled for proper operation – this is achieved by running cold tap water through the water jacket integrated into the accessory shell, or by the use of an external liquid circulator.

UV-Vis DiffusIR – Highly Efficient Collection Optics for Maximum Sensitivity



For advanced temperature studies, environmental chambers are available and may be configured for temperatures from -150 °C to 1000 °C. Using the chamber's porous ceramic sample cups, reaction gases may be flowed through the sample. All chambers are compatible with the FT-IR/ NIR DiffusIR also.



Environmental Chamber for the UV-Vis DiffusIR

Coupling the UV-Vis DiffusIR and environmental chambers with the PIKE PC controlled temperature module and TempPRO™ software provides the ability to graphically set up the experiment with multiple ramps and hold times.

FEATURES

- Micrometer-controlled sample focus to optimize results for every sample
- Optional environmental chambers for heating, cooling and high-vacuum applications
- Quick-release feature of environmental chambers for easy insertion and removal of sealed chambers
- Digital PC temperature controller option for programming ramping rates and isothermal hold times

PIKE Technologies introduces the UV-Vis DiffusIR™ diffuse reflectance accessory for research and routine measurements. Powered optical mirrors are diamond-turned aluminum for optimal performance and reflectivity. The UV-Vis DiffusIR base is completely enclosed to shield against external light. To avoid additional stray light from filtering into the accessory, a magnetically-attached light shield is included to cover the sample slide. The standard configuration offers a two-position slide to accommodate reference and sample cups.

The heart of the UV-Vis DiffusIR is a unique monolithic ellipsoidal reflector permanently fixed in place – eliminating the need for repositioning the focus optics for sample placement. The optical design efficiently collects diffuse radiation generated from the sample. The sample Z-position can be optimized by using the micrometer sample focusing adjustment. In this manner the sensitivity of the accessory is maximized without sacrificing precision. The UV-Vis DiffusIR comes equipped with a Sample Preparation and Loading Kit.

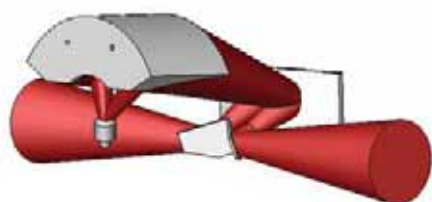

Optical geometry of the UV-Vis DiffusIR

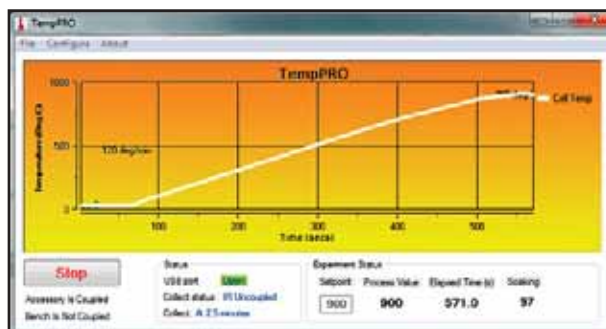

PIKE Technologies TempPRO software provides a graphical interface for temperature control and kinetic measurements.

ORDERING INFORMATION

PART NUMBER	DESCRIPTION
041-10XXX	UV-Vis DiffusIR Accessory <i>Includes Sample Preparation Kit with 2 micro and 2 macro sample cups, sample loading tools, alignment mirror, 35-mm mortar with pestle and KBr powder (100 g)</i>

Notes: Replace XXX with your spectrophotometer's Instrument Code. [Click for List >](#)

OPTIONS

PART NUMBER	DESCRIPTION
162-4150	UV-Vis DiffusIR Environmental Chamber, HTV, ambient to 500 °C
162-4200	UV Vis DiffusIR Environmental Chamber, HTV, ambient to 1000 °C
162-4140	UV-Vis DiffusIR Environmental Chamber, LTV, -150 to 500 °C

Notes: HTV and LTV chambers require the selection of a temperature control module. UV-Vis DiffusIR chambers include front plate accommodating environmental chamber (easily changeable with standard UV-Vis DiffusIR front plate), Pin-Loc chamber insertion for easy sample exchange, KBr window, ceramic sampling cups compatible with vacuum and reaction formats, ports and 2 shut-off valves for vacuum operation and ports for connection of water cooling. Operation of the LTV at sub-ambient temperatures requires PN 162-4165 Liquid Nitrogen-Cooled System and Temperature Control Module, and rotary pump for vacuum insulation.

TEMPERATURE CONTROL MODULES

PART NUMBER	DESCRIPTION
076-2450	PC Controlled Temperature Module, HTV Chambers <i>Includes digital temperature selection and TempPRO software</i>
076-2250	Digital Temperature Control Module, HTV Chambers
162-4165	Liquid Nitrogen Cooled System and Temperature Control Module, DiffusIR Environmental Chamber, LTV, -150 to 500 °C

Notes: PC controlled temperature module with TempPRO software provides a graphical user interface for setting experiment parameters. Please contact PIKE for PC compatibility. The temperature control modules for the HTV and LTV chambers are not interchangeable.

REPLACEMENT PARTS AND SUPPLIES

PART NUMBER	DESCRIPTION
170-1100	Liquid Recirculator
042-2010	Sample Cup, micro, 6-mm diameter, 1.6 mm deep (2 ea.)
042-2020	Sample Cup, macro, 10-mm diameter, 2.3 mm deep (2 ea.)
042-3010	Abrasion Sampling Kit
042-3020	Abrasion Disks, silicon carbide (100 ea.)
042-3025	Abrasion Disks, diamond (50 ea.)
042-3030	Sample Cup Holder and Base
160-8010	KBr Powder, 100 g
042-3040	Sample Preparation Kit
042-3060	Flat Sample Post
042-3080	Alignment Mirror, aluminum
162-4303	Rotary Pump for vacuum insulation

REPLACEMENT PARTS AND SUPPLIES (cont.)

PART NUMBER	DESCRIPTION
160-1132	Disk, KBr, 32 x 3 mm
160-1113	Disk, ZnSe, 32 x 3 mm
160-1372	Disk, UV-Vis SiO ₂ , 32 x 3 mm
160-5049	Disk, SiO ₂ , 32 x 3 mm
160-5125	Disk, low OH SiO ₂ , 32 x 3 mm
160-1143	Disk, CaF ₂ , 32 x 3 mm
162-4210	O-Ring for UV-Vis DiffusIR chamber (10 ea.)
162-4215	O-Ring for UV-Vis DiffusIR chamber cooling line (10 ea.)
162-4251	Ceramic Cup for UV-Vis DiffusIR chamber, porous
162-4270	Alignment Mirror for UV-Vis DiffusIR chamber

Note: Please contact PIKE Technologies for items not described in this list.

SPECIFICATIONS

Optical Design	3X ellipsoidal
Angle of Incidence	30 degrees, nominal
Dimensions (W x D x H)	102 x 225 x 201 mm (excluding light guard tubes and baseplate)
Sample Focus	Micrometer
Sample Positions	2 positions, slide stops for background and sample with no purge loss
Sample Cups	Micro: 6 x 1.6 mm deep Macro: 10 x 2.3 mm deep

ENVIRONMENTAL CHAMBER SPECIFICATIONS

Temperature Range, HTV	Ambient to 500 or 1000 °C
Temperature Range, LTV	-150 to 500 °C
Accuracy	+/- 0.5% of set point
Input Voltage	100–240 VAC (HTV version) 110/220 V switchable (LTV version)
Operating Voltage	28 VDC/84 W (HTV and LTV versions)
Temperature Control	Digital or Digital PC
Heating Rate, Maximum	120 °C/min
Kinetic Setup (requires digital PC controller, includes PIKE TempPRO software)	<ul style="list-style-type: none"> • 100 temperature ramps • Individual ramp rate and hold time settings • Graphical display of experiment settings • USB interface
Sensor	K Type (for HTV) RTD Type, Pt100 (for LTV)
Vacuum Achievable	1 x 10 ⁻⁶ Torr (13 x 10 ⁻⁴ Pa)
Window Size	32 x 3 mm disk
Leaking Rate	< 6.0 x 10 ⁻¹¹ Pa m ³ /sec
Sample Cup Size	6.0-mm OD, 4.0-mm height 4.7-mm ID, 2.0-mm depth
Sample Cup Design	Porous ceramic compatible with powders and gas flow
Cooling Ports	Quick-Fit, 6-mm ID
Gas/Vacuum Ports	1/8" Swagelok®



UV-Vis Calcite Polarizers – Manual and Automated Versions

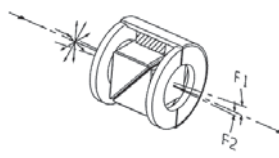

Glan-Taylor field of view

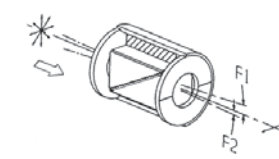
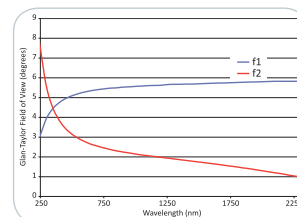

UV Glan-Thompson field of view

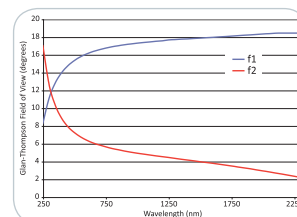

FEATURES

- Glan-Taylor and UV Glan-Thompson designs
- High-grade calcite
- High extinction ratio
- Manual versions – 1 degree settable angular resolution
- Automated version – 0.5 degree angular resolution
- Fits in a standard 2 x 3 inch mount

PIKE Technologies offers Glan-Taylor and Glan-Thompson UV-Vis polarizers. These take advantage of the birefringent properties of UV-quality calcite. An air interface is assembled between two right angle calcite prisms in the Glan-Taylor polarizer whereas a UV-transparent cement separates the calcite prisms in the Glan-Thompson polarizer. In both styles, the polarized extraordinary ray passes through both prisms and the ordinary ray is internally reflected and absorbed. The spectral range of these polarizers is 250–2300 nm. Due to the natural origin of calcite the achievable minimum wavelength fluctuates from polarizer to polarizer. However, at 250 nm the transmission throughput is no less than 25%.

Wavelength (nm)	250	300	400	> 500
Minimum Transmission (%)	25	40	65	85

Each polarizer type has a different field of view where the UV-Vis beam is polarized. The UV Glan-Thompson field of view is wider compared to the Glan-Taylor as shown in the figure.

Enhanced angular resolution of 0.5° is gained with the automated version of the PIKE UV-Vis polarizer. This automated feature is advantageous where highly precise angular settings are required and for increasing the measurement simplicity for determining the polarized orientation of a sample. By evaluating the transmission or reflectance of a sample as a function of the automated polarizer angle at a given wavelength, parallel and perpendicular orientation of the sample relative to the polarizer degree setting may be determined. The automated version includes integrated data collection with some commercial UV-Vis spectrophotometer software packages.

The sample material and sampling configuration dictate the need for a UV-Vis polarizer. Typical materials that may require a polarizer during sampling are often crystals, films, paints, beam splitters, coated glass, and anti-reflective, and anti-glare coatings. Additionally, we recommend using a polarizer for specular reflectance sampling at an angle of incidence greater than 15 degrees where the reflectivity becomes polarization dependent.

SPECIFICATIONS

	Glan-Taylor	UV Glan-Thompson
Material	Calcite	Calcite
Spectral Range	250–2300 nm	250–2300 nm
Clear Aperture	12 mm	14 mm
Extinction Ratio	5 x 10 ⁻⁵	1 x 10 ⁻⁴
Manual Polarizer Dimensions (W x D x H)	29 x 50 x 146 mm	49 x 50 x 146 mm
Automated Polarizer Dimensions (W x D x H)	56 x 50 x 146 mm	56 x 50 x 146 mm
Angular Resolution, Manual	1°	1°
Angular Resolution, Auto	0.5°	0.5°

ORDERING INFORMATION

PART NUMBER	DESCRIPTION
198-1623	Manual Glan-Taylor
198-1624	Manual UV Glan-Thompson
198-1625	Automated Glan-Taylor
198-1626	Automated UV Glan-Thompson

Note: Polarizers may not fit in the sample compartments of some smaller spectrophotometers. The automated polarizers include the PIKE Technologies Motion Control Unit and AutoPRO software for automated operation. Please consult PIKE Technologies before placing an order or to inquire about spectrophotometer side mount holders.



AUTOMATED ACCESSORY

UV-Vis Nanowire Grid Polarizers – Manual and Automated Versions



Automated UV-Vis
Nanowire Grid Polarizer

FEATURES

- Thin profile
- Large acceptance angle, up to 20 degrees
- High transmission and high contrast choices
- Manual and automated versions

PIKE Technologies introduces an innovative new line of high-contrast polarizers covering the UV region and the Vis to NIR region. Using nanofabricating techniques, wire grid lines at a 100-nm pitch are etched on fused silica or glass substrate resulting in a high-performance polarizer. Compared to a traditional calcite polarizer, the large acceptance angle of the nanowire grid polarizer, greater than 20 degrees, eases alignment concerns during use. Additionally, the compact size makes these polarizers ideal for use in confined spaces. The element diameter is 25 mm and has a clear aperture of 19 mm. The polarizer fits a 2 x 3 inch slide mount.

Transmission and contrast ratio of the UV ultra contrast and the broadband polarizers are shown in the next column. Contrast ratio greater than 10,000:1 may be found, making these high-performance polarizers a competitive alternative to calcite polarizers.

There are two manual polarizer types available. The short form has 5 degree scale resolution and the long form has scale resolution of 1 degree. The automated precision polarizers are fully computer controlled and offer the added benefit of increased setting reproducibility with accuracy of +/- 0.5 degree. With automated polarizers an analysis program can be set up through PIKE AutoPRO software, and includes data collection with some spectrophotometer software packages.

SPECIFICATIONS

Substrate	Fused Silica
Performance Range	240–400 nm
UV, Ultra Contrast	300–3200 nm
Vis/NIR	
Element Diameter	25 mm
Clear Aperture	19 mm
Dimensions (W x D x H)	
Manual	50 x 86 x 17 mm
Precision	50 x 146 x 17 mm
Automated	50 x 146 x 55 mm

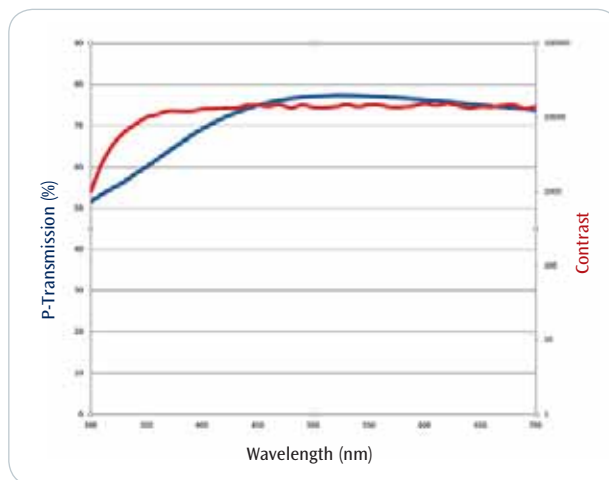

UV Ultra-Contrast Polarizer performance data

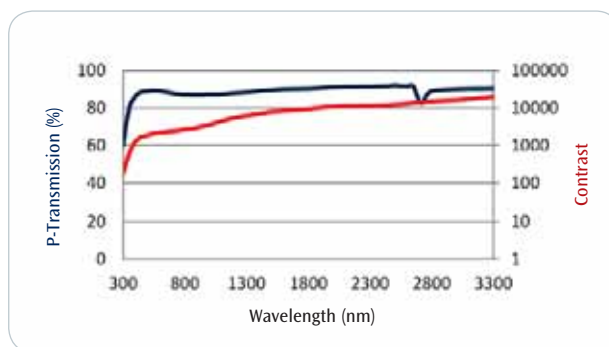

Broadband Polarizer performance data

ORDERING INFORMATION

PART NUMBER	DESCRIPTION
190-2010	Precision UV Polarizer, Ultra Contrast
190-2012	Manual UV Polarizer, Ultra Contrast
190-2015	Precision UV Polarizer, Ultra Contrast, Automated
190-2020	Precision Vis/NIR Broadband Polarizer, High Contrast
190-2022	Manual Vis/NIR Broadband Polarizer, High Contrast
190-2025	Precision Vis/NIR Broadband Polarizer, High Contrast, Automated

Notes: The element diameter is 25 mm. Polarizers may not fit in the sample compartments of some smaller spectrophotometers. The automated polarizers include the PIKE Technologies Motion Control Unit and AutoPRO software for automated operation. Please consult PIKE Technologies before placing an order or to inquire about spectrophotometer slide mount holders.

UV-Vis Spec – Slide Mounted Specular Reflectance Accessories

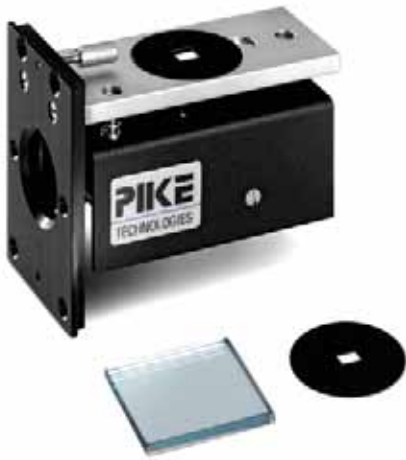

FEATURES

- Fixed angle reflectance accessories including 15, 20, 30, 45 and 60 degrees
- Slide mount design for easy installation
- Optical and anti-reflective coatings testing
- Gloss measurements
- Determining reflectivity of mirrors
- Film thickness calculations

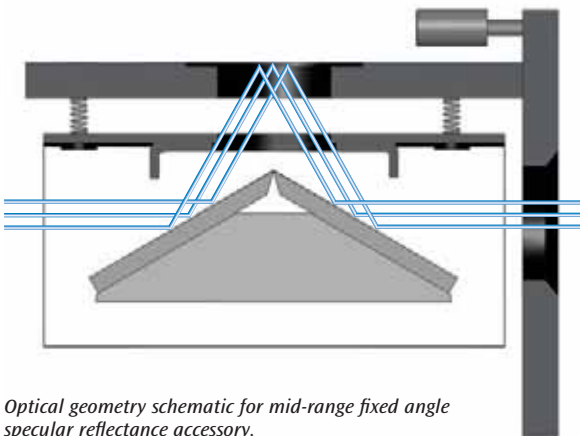

Optical geometry schematic for mid-range fixed angle specular reflectance accessory.

PIKE Technologies relative fixed angle specular reflectance accessories for UV-Vis spectrophotometers span from near-normal to grazing angle. This product sheet highlights our specular reflectance accessories featuring slide mount design. These cover mid-range angles of incidence, between 15–60°, and may be aligned to maximize throughput.

In specular reflectance sampling, the light source is directed to contact the sample at a given angle of incidence. Measured light is collected from the equivalent angle. Typical samples include semiconductors, anti-reflective coatings, color filters, semi-transparent and highly reflective mirrors, optical materials, reflection filters, multiple layers, solar mirrors and solar controlling films on glass. Measured parameters of interest include film thickness, material reflectivity, and coating uniformity and homogeneity.

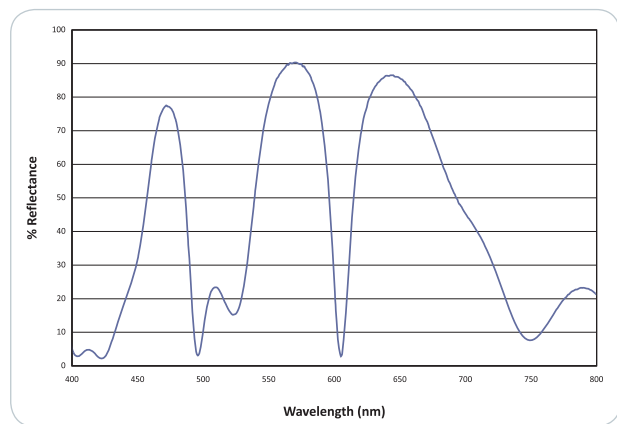

Anti-reflective optics coating spectrum collected using the PIKE UV-Vis 60Spec.

SPECIFICATIONS

Mounting Method	Slide mount
Accessory Dimensions	
Slide Mount (W x D x H)	95 x 51 x 76 mm
Mask Aperture	4 mm x 7 mm
Optical Mirrors	UV-optimized aluminum

ORDERING INFORMATION

FIXED ANGLE SPECULAR REFLECTANCE ACCESSORIES

PART NUMBER	DESCRIPTION
121-1500	UV-Vis 15Spec
121-2000	UV-Vis 20Spec
121-3000	UV-Vis 30Spec
121-4500	UV-Vis 45Spec
121-6000	UV-Vis 60Spec
300-0300	UV Aluminum Mirror, 25.4 mm x 25.4 mm
121-0500	Aperture Mask, 4 mm x 7 mm

Note: Please contact PIKE Technologies to inquire about spectrophotometer sample compartment slide mounts.

UV-Vis 10Spec – Near-normal Sample Reflectivity Measurements



FEATURES

- Measure sample reflectance
- Fixed 10 degree angle of incidence
- Sample illumination using collimated beam precisely fixed at 10 degrees
- Sampling mask sizes of 7, 13 and 25 mm x 4 mm
- Baseplate mount design for stable operation and collection of high-quality spectra

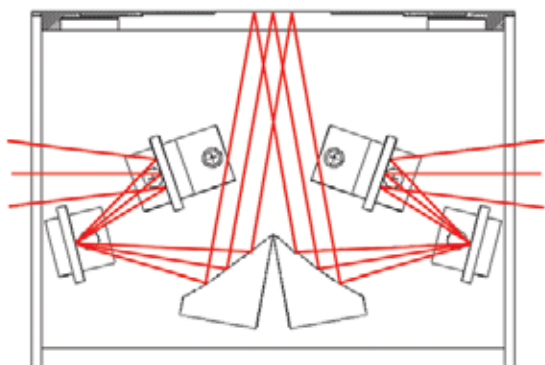

Beam path within the UV-Vis 10Spec specular reflectance accessory.

The PIKE Technologies UV-Vis 10Spec is an optimized specular reflectance accessory designed to make high-performance measurements of sample reflectivity. For slightly focused beams, the UV-Vis 10Spec produces a collimated beam to illuminate the sample area such that the reflectivity measurement is uniformly 10 degrees and not an average of angles produced by a focused beam accessory design. This accessory fits most research-grade spectrophotometers.

The UV-Vis 10Spec may also be used to measure near-normal reflectivity of a wide variety of surfaces including military devices, reflecting optics, anti-reflective (AR) coated surfaces, and other reflecting and non-reflecting materials.

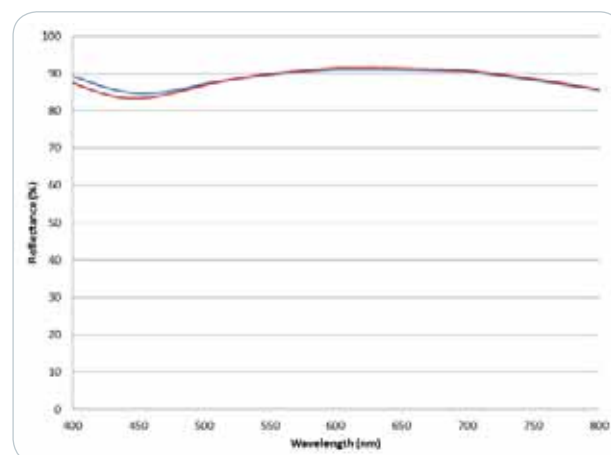

FTIR spectra measuring the reflectivity of SiO₂ coated aluminum mirror with the UV-Vis 10Spec.

ORDERING INFORMATION

PART NUMBER	DESCRIPTION
010-10XXX	UV-Vis 10Spec – 10 Degree Specular Reflectance Accessory Includes 3 sample masks (7, 13 and 25 mm x 4 mm), aluminum alignment mirror and base mount

Note: Replace XXX with your spectrophotometer's Instrument Code. [Click for List >](#)

REPLACEMENT PARTS AND SAMPLING OPTIONS

PART NUMBER	DESCRIPTION
013-4015	Aperture Mask Set, 7, 13, 25 mm x 4 mm
300-0300	UV-Aluminum Mirror, 25.4 mm x 25.4 mm

SPECIFICATIONS

Optics	All reflective
Angle of Incidence	10 degrees
Sample Masks	7, 13 and 25 x 4 mm
Purge Sealing	Purge tubes and purge barb included
Dimensions (W x D x H)	149 x 88 x 118 mm (excludes baseplate)

UV-Vis 85Spec – Specular Reflectance Accessory

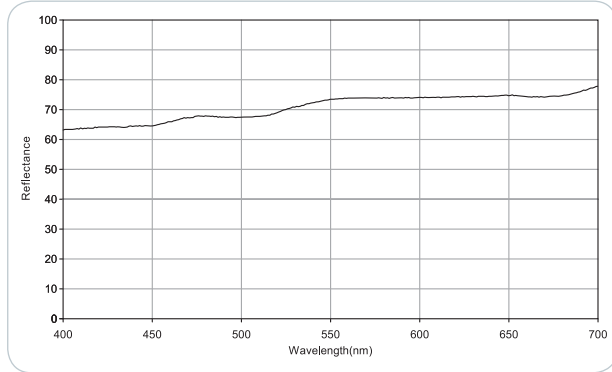

AR-coated ZnSe crystal measured using the 85Spec specular reflectance accessory.

FEATURES AND APPLICATIONS

- Small footprint, compact design
- Fixed 85-degree angle of incidence
- Baseplate mount for stable operation and collection of high-quality spectra
- Thin film and coating measurements

SPECIFICATIONS	
Angle of Incidence	85 degrees
Mounting Method	Baseplate
Dimensions (W x D x H)	105 x 84 x 76 mm
Mask Aperture	35 x 3 mm
Optical Mirrors	UV-optimized aluminum

ORDERING INFORMATION

PART NUMBER	DESCRIPTION
121-85XXX	UV-Vis 85Spec – 85 Degree Specular Reflectance Accessory Includes an Al substrate alignment mirror and sample mask

Note: Replace XXX with your spectrophotometer's Instrument Code. [Click for List >](#)

REPLACEMENT PARTS	
PART NUMBER	DESCRIPTION
300-0301	UV-Aluminum Mirror, 38.1 mm x 38.1 mm
121-0501	Aperture Mask, 35 mm x 3 mm

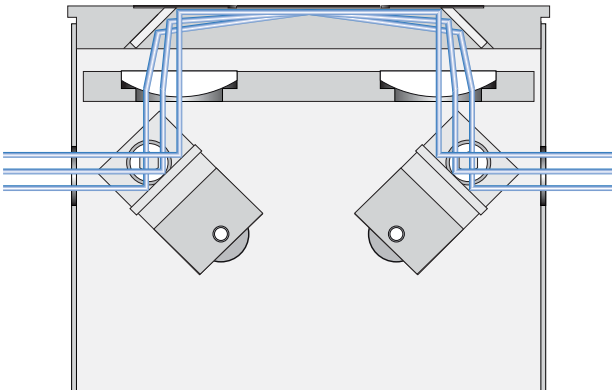

Optical diagram of the UV-Vis 85Spec specular reflectance accessory.

The 85Spec is an 85-degree specular reflectance accessory developed for UV-Vis applications. The accessory is used to analyze mirror-like planar surfaces and thin films on planar surfaces. The grazing angle measurements give the longest possible pathlength through coated samples.

Pre-mounted on a baseplate specific to your UV-Vis spectrophotometer, the 85Spec is an easy-to-use accessory. The mounting allows the 85Spec to be inserted and removed from the sample compartment without alignment.

UV-Vis VeeMAX – Variable Angle Specular Reflectance Accessory



FEATURES AND APPLICATIONS

- Selectable angle of incidence – from 30 to 80 degrees in one degree increments
- Film and coating thickness measurements at optimized angle of incidence
- Grazing angle measurements for the longest path through ultra-thin films
- Characterization of variable reflectivity materials

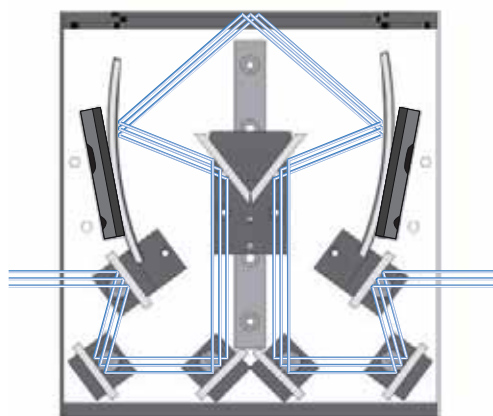

Optical geometry schematic for UV-Vis VeeMAX variable angle specular reflectance accessory.

In specular reflectance sampling, the light source is directed to contact the sample at a given angle of incidence. Measured light is collected from the equivalent angle. Typical samples include semiconductors, anti-reflective coatings, spectral wavelength filters, semi-transparent and highly reflective mirrors, optical materials, reflection filters, multiple layers, solar mirrors, and solar controlling films on glass. Measured parameters of interest include film thickness, material reflectivity, and coating uniformity and homogeneity.

With the UV-Vis VeeMAX™ accessory find versatility for specular reflectance measurements. The angle of incidence from 30 degrees to 80 degrees is easily changed by turning the angle setting dial.

This flexibility allows for optimization of spectral quality for film and coating measurements. In other applications where it is desirable to study the effect of incident angle upon reflected radiation, the UV-Vis VeeMAX offers a sampling solution. For samples such as reflectors, bandpass filters, and hot and cold mirrors. The UV-Vis VeeMAX makes an ideal accessory used to replicate real-world situations such as the effect of a rising and setting sun on absorbance efficiency of solar collectors and architectural glass performance.

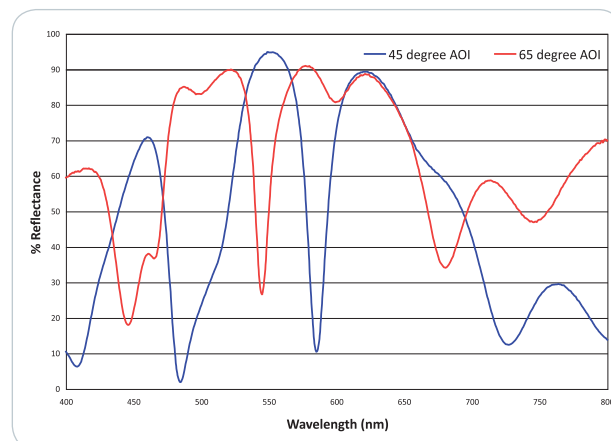

Specular reflectance collected at two different angles of incidence of an anti-reflective coating.

SPECIFICATIONS

Angle of Incidence	30–80 degrees
Mounting Method	Baseplate
Nominal Accessory Dimensions (W x D x H) (dimensions vary with spectrophotometer type)	145 x 135 x 158 mm
Minimum Beam Height	50 mm
Mask Aperture	7 mm x 4 mm 13 mm x 4 mm 25 mm x 4 mm
Optical Mirrors	UV-optimized aluminum

ORDERING INFORMATION

PART NUMBER	DESCRIPTION
013-10XXX	UV-Vis VeeMAX Variable Angle Specular Reflectance Accessory <i>Includes masks and aluminum mirror</i>

Note: Replace XXX with your spectrophotometer's Instrument Code. [Click for List >](#)

REPLACEMENT PARTS

PART NUMBER	DESCRIPTION
300-0300	UV Aluminum Mirror, 25.4 mm x 25.4 mm
013-4015	Aperture Mask Set, 7, 13 and 25 mm x 4 mm

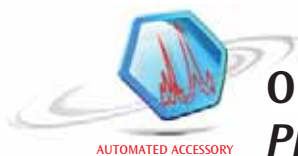

Out-of-Compartment Microplate Reader – Plate Reading Option for UV-Vis Spectrophotometers

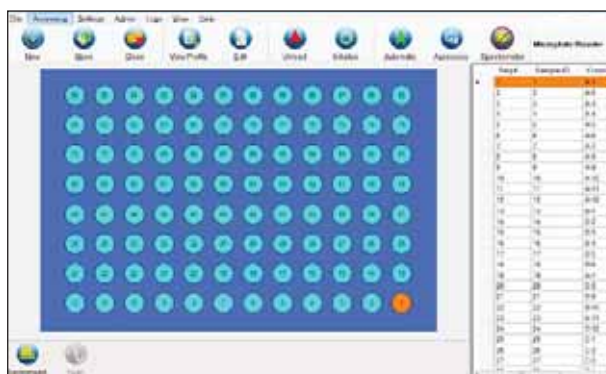
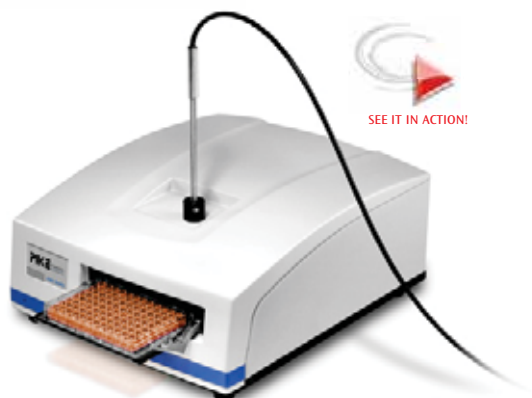

AutoPRO Software – Microplate Reader configuration screen.

FEATURES

- Microplate reading option for standard UV-Vis spectrophotometers
- Scanning and fixed wavelength measurements (spectrophotometer dependent)
- On-board detector
- 6-well to 384-well microplate reading capability
- Custom configurations for automated sampling
- CD-style loading for autoloader interface

The PIKE Technologies Out-of-Compartment Microplate Reader is a unique option available for UV-Vis spectrophotometers. It offers high throughput plate reading capability to a wide range of traditional instruments with standard sample compartments. This allows for flexibility when conducting experiments that require optical configuration for cuvettes, temperature control, integrating spheres (among others) and extra microplate reading functionality when needed. Microplate reading capability is often required in research, drug discovery, bioassay validation, quality control and manufacturing processes in the pharmaceutical and biotechnological industry and academia. The PIKE Microplate Reader can also be adapted to perform automated measurements of filters, optical components and other materials.

The Microplate Reader module features a small footprint and can be positioned next to or above the spectrophotometer. Using a fiber coupler in the sample compartment, the light is sent to the accessory via a single optical fiber probe and collected by an on-board photodiode detector.

The mechanical design of the accessory relies on an X, Y stage with both axes driven by high-precision servo motors with optical encoders for speed and reproducibility. USB and DC power are the only external connections required for this accessory.

Programming and control of the Microplate Reader is done through PIKE Technologies AutoPRO software, which can be integrated with many third-party UV-Vis software packages.

SPECIFICATIONS

Optics	Transfer optics module, optical fiber probe and photodiode detector
Accuracy	+/- 25 μ m
Mechanical Specifications	
Repeatability	+/- 5 μ m
Resolution	1 μ m
Run Time	96-well plate – 32 seconds 384-well plate – 84 seconds
Computer Interface	USB
Power Requirements	100–240 Volts AC 50/60 Hz
Dimensions (W x D x H)	11.6 x 13.7 x 6"
Weight	15 lbs

ORDERING INFORMATION

PART NUMBER	DESCRIPTION
047-10XXX	Microplate Reader Accessory

Note: Replace XXX with your spectrophotometer's Instrument Code. [Click for List >](#)

OPTION

PART NUMBER	DESCRIPTION
162-1910	96-Well Polystyrene Sample Plate

REQUIRED OPTICAL COMPONENTS (must select fiber optic probe and photodiode detector)

PART NUMBER	DESCRIPTION
047-3011	Photodiode Detector, Cary 50/60
047-3030	Optical Fiber Probe

Note: Contact PIKE Technologies to verify that the accessory is compatible with your spectrophotometer. Requires fiber optic launch optics or fiber couple from spectrophotometer manufacturer.

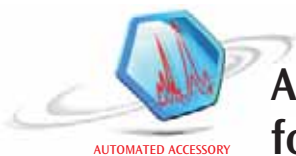

Automated Transmission R-Theta Rotational Stages for UV-Vis Spectrophotometers



FEATURES

- R-theta motion mapping optical samples
- Complete hardware and software interface package for automated, multi-position measurements
- Light-tight enclosure included
- Custom inserts available

PIKE Technologies' vertical R-theta computer controlled accessories for translating and rotating samples in the spectrophotometer beam. These tools enable transmission mapping of sample surfaces and generating spectroscopy data as a function of sample position. Suitable for determination of film and coating thickness, multilayer film analysis, reflectivity studies and characterization of optical materials. Using the standard sample wheel and custom inserts, these accessories are suitable for analyzing small and large size samples including coated and uncoated glass, optical filters, solar panels and similar materials. Support ring mounts on the accessory's drive and is rotated and translated laterally to produce an R-theta motion covering the entire sampling range of the accessory. Each system incorporates two precision stepper motors for the plate movement.

The operation is managed by PIKE AutoPRO™ software which provides full user programmability and an easy to learn “point-and-click” environment. Polar or X and Y coordinates may be used to define test points. The AutoPRO software allows complex test sequences to be set up, stored as methods and implemented for full flexibility. Each automated accessory is tailored to meet specific sampling needs. This includes adjustments for sample shape/size, and the type of spectroscopic data required. Please contact PIKE Technologies to verify that the selected stage can be integrated into your spectrophotometer's sample compartment and for custom sample inserts.

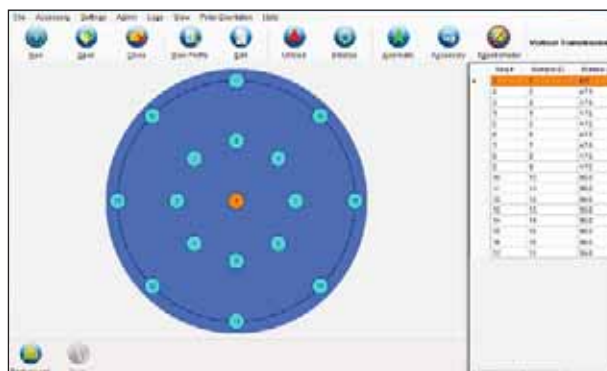

AutoPRO software configured for the Vertical Transmission Accessory.

ORDERING INFORMATION

PART NUMBER	DESCRIPTION
073-4011	Vertical 12 inch (300 mm) Transmission Accessory – Cary 5000/6000 <i>Includes vertical mapping stage with light enclosure, motor controller</i>
073-5100	Vertical 12 inch (300 mm) Transmission Accessory – Lambda 750/850/950/1050 <i>Includes vertical mapping stage with light enclosure, motor controller</i>
073- 5011	Vertical 8 inch (200 mm) Transmission Accessory – Cary 5000/6000 <i>Includes vertical mapping stage with light enclosure, motor controller</i>
073-5010	Vertical 8 inch (200 mm) Transmission Accessory – Cary 500/500 <i>Includes vertical mapping stage with light enclosure, motor controller</i>

Note: For sizes not listed here or custom inserts, please contact PIKE Technologies. Ask about X, Y movement accessories and horizontal stages.



STANDARDS, SOFTWARE, DATABASES

We strive to provide you with useful sampling tools for spectroscopy and offer these additional products and information to serve your laboratory requirements. If you have not found the ideal sampling tool, please contact us. Your spectroscopy sampling requirements may become one of our product offerings in the future.

Reference Standards [Page 156](#)
For calibrating your spectrometer

PIKECalc™ [Page 159](#)
For FTIR sampling computations

Spectral Databases [Page 160](#)
ATR and transmission versions for your FTIR

Reference Standards – For Calibrating FTIR Spectrometers

FEATURES

- Mid-IR and NIR spectral regions products
- Transmission, reflection and ATR versions
- Traceable versions available

FTIR spectrometers are highly accurate and reliable measurement tools. Their internal referencing laser (Connes advantage) is a great leap forward in wavenumber accuracy and repeatability. Still, it is often required by regulatory agencies and operating procedures to calibrate the spectrometer. PIKE Technologies offers several new products to assist in this task

PIKE Technologies offers several versions of **polystyrene reference materials** for FTIR spectrometer calibration. The 1.5 mil and 55 micron thick polystyrene are generally specified for calibrating wavenumber accuracy. A NIST traceable polystyrene version of these products is available which includes the reference material, calibration result for the material and its traceability documentation.



Polystyrene Reference Standards – for calibrating FTIR wavenumber accuracy

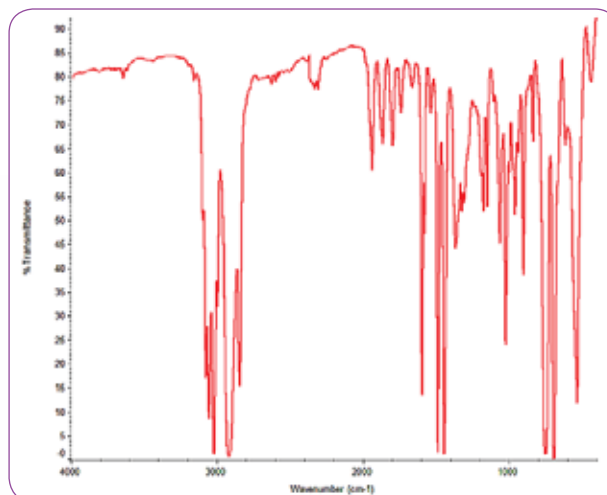

Polystyrene Reference Standard spectrum.

To evaluate FTIR instrument photometric linearity, PIKE offers the **NG11 Reference Standard** traceable to National Research Council of Canada. The traceability documentation included shows transmission values at seven band assignments. The range covered is 4000 to 2000 cm^{-1} . The NG11 element comes mounted in a standard 2 x 3 inch slide.



NG11 Linearity Reference Standard

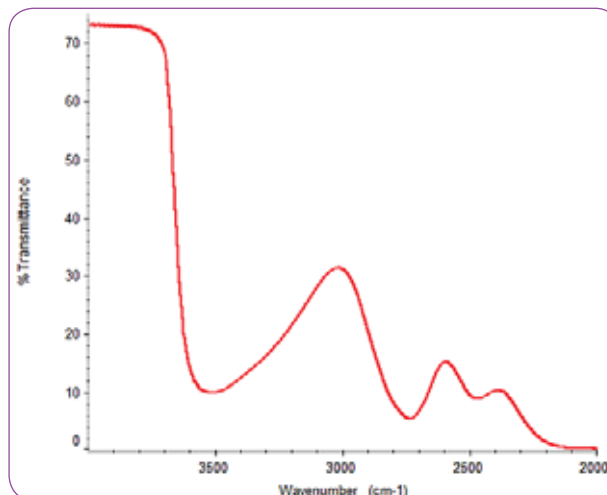

NG11 Reference Standard spectrum.

For diffuse reflectance measurements in the NIR and UV-Visible spectral region, it is often desirable to measure against the highest possible reflectance material. **NIR and UV-Vis Diffuse Reflectance Standards** are available in highly reflective diffuse gold and PTFE. Each standard is certified to a National Research Council of Canada traceable plaque standard.

Diffuse Gold Reference Standard

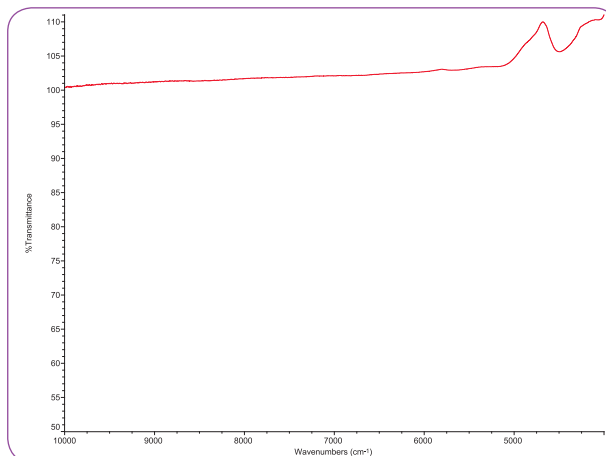

Measured reflectivity of Diffuse Gold Reference Standard.

Diffuse reflectance sampling in the mid-infrared region is used to measure the reflectance of powders, films, painted panels and other samples. Exhibiting sharp peaks throughout the mid-IR spectral region, the **Mid-IR Diffuse Reflectance Wavelength Standard** is used to verify and calibrate for wavelength accuracy or diffuse reflectance measurements. This standard is NIST traceable to NIST 1921b and an analysis certificate is included.

Mid-IR Diffuse Reflectance Wavelength Standard

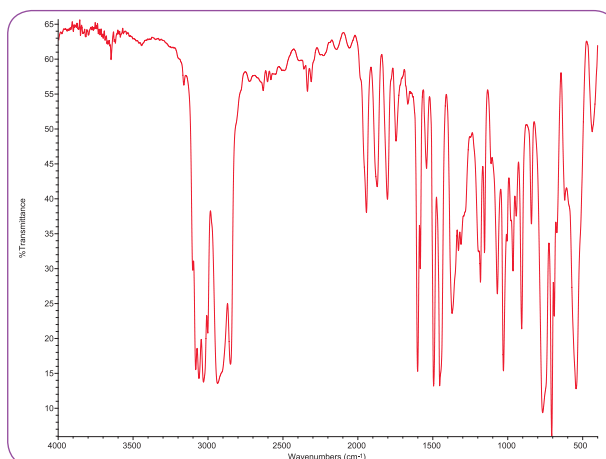

Mid-IR Diffuse Reflectance Standard spectrum.

The **Specular Reflectance Standard** is a unique material for calibration of your reflectance measurement system. The standard is a specially treated germanium element which only allows reflection from its front surface – thereby providing a reflection value which can be calculated relative to Fresnel equations.

The Specular Reflectance Standard includes documentation to trace the specular reflectance to published refractive index data. It is compatible with the following PIKE Technologies specular reflectance accessories: VeeMAX III, 10Spec, 30Spec, 45Spec and 80Spec.

Specular Reflectance Standard – for calibrating reflectance measurement system

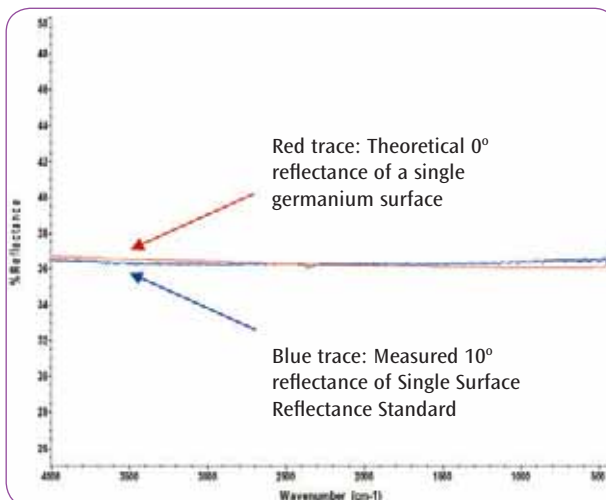

Comparison of measured and calculated reflectance for the Specular Reflectance Standard using the PIKE 10Spec accessory.

In the near infrared (NIR) spectral region, PIKE Technologies offers its **NIR Wavelength Standard** for calibrating a NIR spectrometer. The NIR Wavelength Standard meets USP wavelength requirements, provides calibration beyond 2.0 μm and is NIST traceable. This standard is compatible with NIR analysis in the diffuse reflectance sampling mode. The NIR Wavelength Standard includes analysis certificate and traceability documentation.

NIR Wavelength Standard

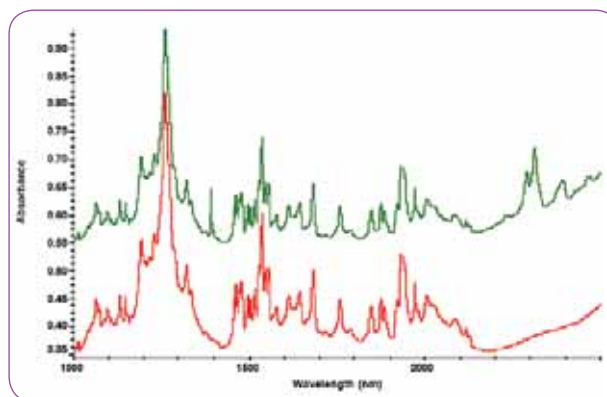

NIR Wavelength Standard spectral data. PIKE NIR Wavelength Standard (upper green spectrum), NIR standard from another supplier (lower red spectrum).

ATR spectra are somewhat different than those produced by transmission sampling techniques – both in relative intensity of the absorbance bands and also the position of the bands. To assist with calibrating your ATR/FTIR system, PIKE Technologies offers an **ATR Reference Standard**. The ATR Reference Standard is available as a standard material and also in a version which includes a recommended validation procedure for your ATR/FTIR system.

ATR Reference Standard

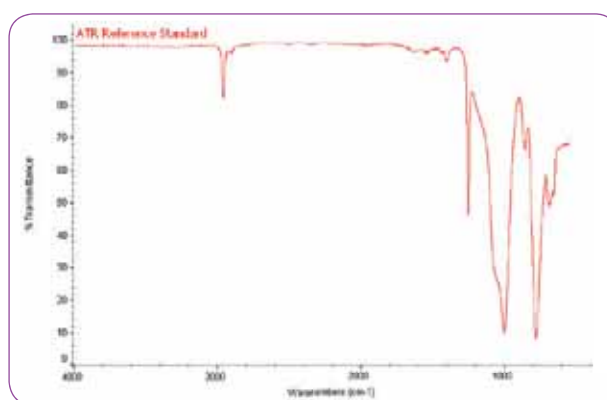

ATR Reference Standard spectrum.



ORDERING INFORMATION

POLYSTYRENE REFERENCE STANDARDS

PART NUMBER	DESCRIPTION
162-5450	NIST Traceable Polystyrene Reference Standard, 1.5 mil
162-5420	Polystyrene Reference Standard, 1.5 mil (38 micron)
162-5440	Polystyrene Reference Standard, 2.2 mil (55 micron)

Note: Polystyrene reference standards are mounted in a 2" x 3" card and are compatible with all FTIR spectrometers.

NG11 LINEARITY REFERENCE STANDARD

PART NUMBER	DESCRIPTION
162-5490	NG11 Transmission Standard

SPECULAR REFLECTANCE STANDARD

PART NUMBER	DESCRIPTION
162-5460	Specular Reflectance Standard

Note: Compatible with 10Spec, 30Spec, 45Spec, 80Spec and VeeMAX III accessories.

NIR AND UV-VIS DIFFUSE REFLECTANCE STANDARDS

PART NUMBER	DESCRIPTION
162-5480	Diffuse PTFE Reference, 0.9" optical diameter
162-5481	Diffuse Gold Reference, 0.9" optical diameter
162-5482	Diffuse Gold Reference, 1.7" optical diameter

MID-IR DIFFUSE REFLECTANCE STANDARDS

PART NUMBER	DESCRIPTION
162-5485	Mid-IR Diffuse Reflectance Wavelength Standard, 1.75" optical diameter
162-5486	Mid-IR Diffuse Reflectance Wavelength Recertification

ATR REFERENCE STANDARD

PART NUMBER	DESCRIPTION
162-5470	ATR Reference Standard
162-5475	ATR Reference Standard with Recommended Validation Procedure and Validation Certificate, ZnSe
162-5473	ATR Reference Standard with Recommended Validation Procedure and Validation Certificate, Diamond
162-5474	ATR Reference Standard with Recommended Validation Procedure and Validation Certificate, Ge
162-5476	ATR Reference Standard Recertification

Note: Compatible with MIRacle, GladiATR and VeeMAX III with ATR accessories.

NIR WAVELENGTH STANDARD

PART NUMBER	DESCRIPTION
162-5483	Traceable NIR Reference Standard, 0.9" optical diameter
162-5484	Traceable NIR Reference Standard Recertification

Note: Includes traceability measurement documentation.

PIKECalc Software – For FTIR Sampling Computations

FEATURES

- Convert from wavelength (micron and nanometer) to wavenumber
- Calculate depth of penetration, critical angle, effective pathlength, effective angle of incidence and number of reflections for ATR
- Calculate cell pathlength, thickness of free-standing film and thickness of coating
- FREE access online at www.piketech.com

PIKECalc software is easy to use – just select the type of computation, enter values from your spectral data and click on the calculate button. An instant calculation is performed.

PIKECalc eliminates the need to search through literature references to find the correct conversions and formulae and gives you immediate results. All formulae and equations are documented in the software, if you wish to reference our mathematics. Help and how to use PIKECalc is included within the software.

Please ask us about other FTIR spectroscopy calculations you may need.

To activate our free on-line interactive Crystal Properties program and FTIR Calculator, select a gold button on the homepage of our website: www.piketech.com. The FTIR Calculator allows for wavelength to wavenumber conversion, pathlength and film thickness determination, and ATR calculations. Refer to our Crystal Properties program to choose the best crystal to use for your application.

CRYSTAL
PROPERTIES >>

FT-IR
CALCULATOR >>

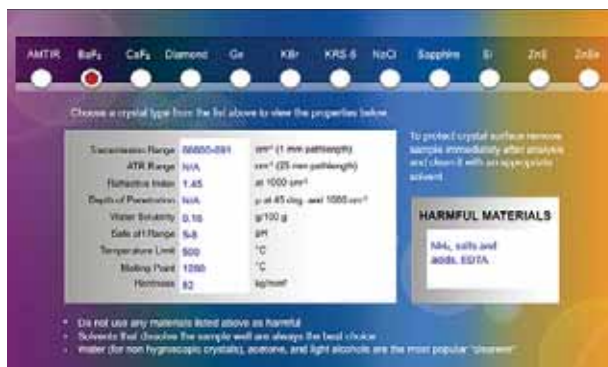

Crystal Properties program available online.



Conversions function of the online FTIR Calculator.

ORDERING INFORMATION

PART NUMBER	DESCRIPTION
007-0300	PIKECalc Software on CD

Notes: PIKECalc is loaded on a CD disk for upload to your PC and operates with current versions of Microsoft operating systems.

ATR Spectral Databases – Optimize Search Results for ATR Spectral Data

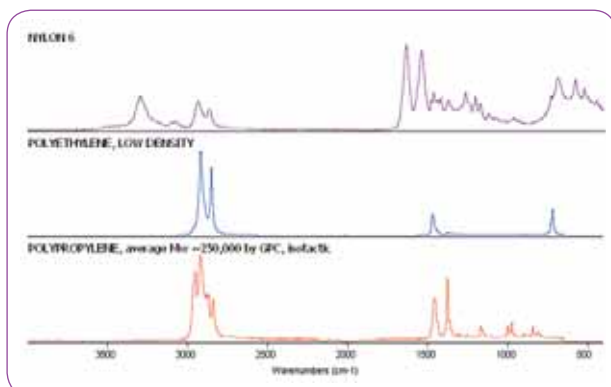

FEATURES

- Select from databases with over 40,000 ATR spectra
- All spectra collected using FTIR spectrometers and a single reflection ATR
- Complete collections and applications databases available
- Compatible with most FTIR software

Spectral search is greatly improved when using databases collected using the same sampling mode – especially when the sampling mode is ATR. PIKE Technologies offers a large selection of ATR spectral databases.

The Aldrich ATR Spectral Database contains 18,513 spectra produced by the Aldrich Chemical Company. The collection includes organic and inorganic compounds and also includes polymers and industrial chemicals. Spectral range is 4000–650 cm^{-1} .

The IChem ATR Spectral Database contains 13,557 spectra produced by Fine Chemical manufacturers in Japan. This collection includes organic and inorganic compounds, basic polymers and industrial chemicals. Spectral range is 4000–650 cm^{-1} .

The Aldrich-IChem ATR Spectral Database Package includes 40,810 spectra, a combination of all ATR spectra from both databases – with no duplicate entries.

A wide variety of applications spectral database packages are formed from the Aldrich ATR and the IChem ATR databases.

These spectral databases are compatible with ABB Horizon MB™, ACD/Labs, Bruker Opus, Jasco Spectra Manager™ Suite, Lumex SpectraLUM/Pro®, PerkinElmer Spectrum 10™, WinFirst™, Shimadzu IRSolution and HyperIR, LabControl SPECTACLE, Thermo Scientific OMNIC™, Varian Resolutions Pro™, GRAMS and Spectral ID software packages and more. A USB port is required on your PC where a dongle is installed for copy protection.

ORDERING INFORMATION

ATR SPECTRAL DATABASES

PART NUMBER	DESCRIPTION
008-1000	Aldrich ATR Spectral Database (18,513 spectra)
008-2000	IChem ATR Spectral Database (13,557 spectra)
008-3000	Aldrich-IChem ATR Spectral Database Package (40,810 spectra)

Notes: The spectral databases include a USB-based device – dongle for copy protection. Please designate either 2 cm^{-1} or 4 cm^{-1} spectral data format.

ATR APPLICATION SPECIFIC SPECTRAL DATABASES

PART NUMBER	DESCRIPTION
008-3002	ATR Applications – Polymers and Polymer Additives (7,970 spectra)
008-3003	ATR Applications – Food Additives and Food Packaging (4,239 spectra)
008-3004	ATR Applications – Solvents (1,313 spectra)
008-3005	ATR Applications – Organometallics and Inorganics (2,125 spectra)
008-3006	ATR Applications – Biochemicals (7,529 spectra)
008-3007	ATR Applications – Aldehydes and Ketones (5,162 spectra)
008-3008	ATR Applications – Alcohols and Phenols (3,700 spectra)
008-3009	ATR Applications – Esters and Lactones (8,326 spectra)
008-3010	ATR Applications – Hydrocarbons (1,141 spectra)
008-3011	ATR Applications – Flavors, Fragrances and Cosmetic Ingredients (4,060 spectra)
008-3012	ATR Applications – Pesticides (3,211 spectra)
008-3013	ATR Applications – Semiconductor Chemicals (1,379 spectra)
008-3014	ATR Applications – Forensic (3,770 spectra)
008-3015	ATR Applications – Dyes, Pigments and Stains (3,561 spectra)
008-3016	ATR Applications – Sulfur and Phosphorus Compounds (5,655 spectra)
008-3017	ATR Applications – Hazardous Chemicals (6,698 spectra)
008-3018	ATR Applications – Hazardous and Toxic Chemicals (4,022 spectra)
008-3020	ATR Applications – Pharmaceuticals, Drugs and Antibiotics (4,796 spectra)
008-3021	ATR Applications – High Production Volume (HPV) Chemicals (2,032 spectra)
008-3025	ATR Applications – Coatings (2,433 spectra)
008-3026	ATR Applications – Paints (3,426 spectra)

Notes: The spectral databases include a USB-based device – dongle for copy protection. Please designate either 2 cm^{-1} or 4 cm^{-1} spectral data format. Specify your FTIR software for correct format. Due to new additions or revisions to databases, spectral quantities may fluctuate. Please call for exact specifications at time of order.

Transmission Spectral Databases – High-Quality Spectral Data for Optimized Search Results

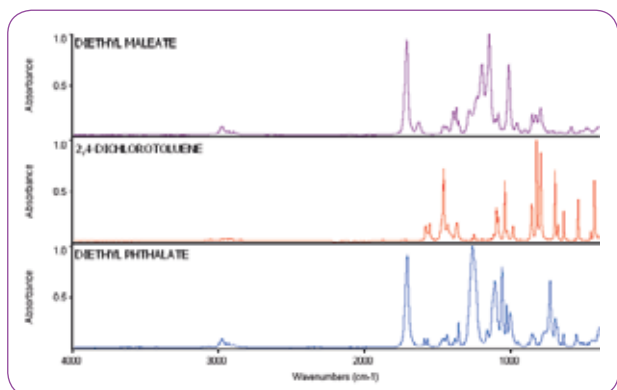

FEATURES

- Select from databases with over 50,000 transmission spectra
- All spectra collected using FTIR spectrometers and transmission sampling mode
- Complete collections and applications databases available
- Compatible with most FTIR software

PIKE Technologies offers a large collection of high-quality, spectral databases collected in the transmission sampling mode.

The **SDBS Transmission Spectral Databases** include over 50,000 spectra produced by Fine Chemical manufacturers in Japan. All spectra were collected at the Japanese National Laboratories under highly controlled conditions with secondary verification of the materials by NMR and MS. Data is measured using several sample preparation methods. Spectral range is 4000–400 cm^{-1} .

The **SDBS Transmission by KBr Pellet Spectral Database** contains 22,995 spectra. This collection includes organic and inorganic compounds, basic polymers and industrial chemicals.

The **SDBS Transmission by Liquid Film Spectral Database** contains 7,018 spectra. This collection includes organic compounds and industrial chemicals.

The **SDBS Transmission by Nujol Mull Spectral Database** contains 21,127 spectra. This collection includes organic and inorganic compounds and industrial chemicals.

A wide variety of applications spectral database packages are formed from the KBr Pellet and Liquid Film Spectral Databases.

These spectral databases are compatible with ABB Horizon MB™, ACD/Labs, Bruker Opus, Jasco Spectra Manager™ Suite, Lumex SpectralUM/Pro®, PerkinElmer Spectrum 10™, WinFirst™, Shimadzu IRSolution and HyperIR, LabControl SPECTACLE, Thermo Scientific OMNIC™, Varian Resolutions Pro™, GRAMS and Spectral ID software packages and more. A USB port is required on your PC where a dongle is installed for copy protection.

ORDERING INFORMATION

TRANSMISSION SPECTRAL DATABASES

PART NUMBER	DESCRIPTION
008-4001	SDBS Transmission by KBr Pellet Spectral Database (22,995 spectra)
008-4004	SDBS Transmission by Liquid Film Spectral Database (7,018 spectra)
008-4005	SDBS Transmission by Nujol Mull Spectral Database (21,127 spectra)

Notes: The spectral databases include a USB based device – dongle for copy protection. Please designate either 2 cm^{-1} or 4 cm^{-1} spectral data format.

APPLICATION BASED SPECTRAL DATABASES

PART NUMBER	DESCRIPTION
008-5002	Transmission Applications – Polymers and Polymer Additives (1,273 spectra)
008-5003	Transmission Applications – Food Additives and Food Packaging (1,684 spectra)
008-5004	Transmission Applications – Solvents (668 spectra)
008-5005	Transmission Applications – Organometallics and Inorganics (1,445 spectra)
008-5006	Transmission Applications – Biochemicals (4,590 spectra)
008-5007	Transmission Applications – Aldehydes and Ketones (4,226 spectra)
008-5008	Transmission Applications – Alcohols and Phenols (2,744 spectra)
008-5009	Transmission Applications – Esters and Lactones (4,335 spectra)
008-5010	Transmission Applications – Hydrocarbons (1,417 spectra)
008-5011	Transmission Applications – Flavors, Fragrances and Cosmetic Ingredients (1,912 spectra)
008-5012	Transmission Applications – Pesticides (958 spectra)
008-5013	Transmission Applications – Semiconductor Chemicals (664 spectra)
008-5014	Transmission Applications – Forensic (1,555 spectra)
008-5015	Transmission Applications – Dyes, Pigments and Stains (1,473 spectra)
008-5016	Transmission Applications – Sulfur and Phosphorus Compounds (5,025 spectra)
008-5017	Transmission Applications – Hazardous Chemicals (2,664 spectra)
008-5018	Transmission Applications – Toxic Chemicals (6,604 spectra)
008-5020	Transmission Applications – Pharmaceuticals, Drugs and Antibiotics (2,806 spectra)
008-5021	Transmission Applications – High Production Volume (HPV) Chemicals (1,123 spectra)
008-70051	Transmission Applications – Kidney Stones (1,668 spectra)

Notes: The spectral databases include a USB-based device – dongle for copy protection. Please designate either 2 cm^{-1} or 4 cm^{-1} spectral data format. Specify your FTIR software for correct format. Due to new additions or revisions to databases, spectral quantities may fluctuate. Please call for exact specifications at time of order.

ALPHABETICAL INDEX

10Spec, Specular Reflectance	54, 150
15Spec, Specular Reflectance	149
20Spec, UV-Vis Specular Reflectance	149
30Spec Specular Reflectance	55, 149
45Spec, Specular Reflectance	55, 149
60Spec, UV-Vis Specular Reflectance	149
80Spec, Specular Reflectance	56
85Spec, UV-Vis Specular Reflectance	151

A

Abrasion Sampling Kit	42, 44, 48
Absolute Reflectance Accessory	58
AGA, Specular Reflectance	57
Alignment Mirror, 10Spec, 80Spec and VeeMAX III	53, 54, 56
Alignment Mirror, 30Spec and 45Spec	55
Alignment Mirror, UV-Vis	150, 152
Anvils for KBr Pellet Dies	105, 106
ATR Crystal Properties	39, 128
ATR, Multiple Reflection	6, 10, 21, 26
ATR, Single Reflection	7, 10, 15, 18
ATR, Variable Angle	26, 29
ATR Theory	37
AutoATR	32
AutoDiff, Automated Diffuse Reflectance	46
Automated Wafer Analysis	130, 131

B

BaF ₂ Disks/Windows	114
BaF ₂ Properties	128
Beam Condensers	88
Bolt Press	105

C

CaF ₂ Properties	128
CaF ₂ Disks/Windows	114
Card, Disposable Sample Holder	113
Catalytic Heat Chambers	43
Cell Holders	100, 113, 118
Cells, Long-Path Quartz	100
Chunks, KBr	114
Comprehensive Transmission Kit	4
Compression Cells	85, 86
Compression Cell, Diamond	86
CrushIR Hydraulic Press	108
Crystal Polishing Kit	117
Crystal Properties	39, 128
CsI Properties	111
CsI Disks/Windows	114, 115, 116
Cuvettes	140
Cuvette Holders	141, 142, 144

D

Demountable Liquid Cell	97
Diamond ATR Accessory	7, 10, 15, 18, 74
Diamond ATR Probe	74
Diamond Compression Cell	86
Diamond Properties	39, 128
Diffuse Reflectance, Automated	46, 47
Diffuse Reflectance, Heating	43
Diffuse Reflectance Products	40
Diffuse Reflectance Theory	49
DiffusIR Diffuse Reflectance Accessory	43
Digital Force Adapter for High-Pressure Clamp	12, 14, 17
Disks, UV-Vis, NIR and IR Windows	114

E

EasiDiff Diffuse Reflectance Accessory	42
Education Sampling Kit	5
Electrochemistry	30, 53
External Sample Module	136

F

Falcon Mid-IR Transmission Accessory	101
Falcon NIR Transmission Accessory	103
Falcon UV-Vis Transmission Accessory	144
Fiber Optic Accessories	74, 77
Film Maker	108, 110
FlexIR, Mid-IR Hollow Waveguide Accessory	74
FlexIR, NIR Fiber Optic Accessory	77
Fluorolube	112
FTIR Instrument Codes	165

G

Gas Cell, Heated	119, 120, 121, 123, 133
Gas Cell Holders	113, 118
Gas Cells, Long-Path	123
Gas Cell, Low-Volume	120
Gas Cells, Short-Path Stainless Steel	121
Gas Cells, Short-Path Glass	118
GC-FTIR Interface Accessory	135
Ge Disks/Windows	114
Ge Properties	128
GladiATR	15, 18
GladiATR Options	20
GladiATR Vision	18
Grazing Angle, Specular Reflectance	52, 56, 57
Grinders, ShakIR and Super ShakIR	111

H

Hand Press	3, 4, 105
HATR	6, 21
HATRPlus	21
Heated, ATR	10, 15, 18, 21, 26, 29
Heated, Diffuse Reflectance	43
Heated, Liquid Sample Holder	101, 103, 142, 144
Heated Platens Accessory	110
Heated S100-R Microscope Stage	87
Heated Solid Transmission Accessory	104
Heated Transmission Cell	101, 103, 104, 142, 144
Holders, Sample	113
Holder, Pellets	113
Holder Sample Cards	113
Hydraulic Die	105, 106, 107, 108, 109
Hydraulic Press	2, 107, 108, 109

I

Instrument Codes	165
Integrating Sphere, Mid-IR	66, 68, 69
Integrating Sphere, NIR	69
Infrared Disks/Windows	114

J

JetStream ATR	34
---------------	----

K

KBr, Chunks and Powder	112
KBr Disks/Windows	114, 115, 116
KBr Pellet Making Press	105, 106, 107, 108, 109
KBr Properties	128

L

Luer Syringes	98, 99, 102
Library Spectra	160, 161
Liquid Transmission Cells	2, 3, 4, 5, 98, 99, 101
Liquid Cell, Demountable	98
Liquid Cell, Sealed	99
Liquid Recirculator	44, 101, 103, 104, 143, 144, 145
Liquids Retainer and Volatiles Cover	13, 14, 17, 19, 20
Liquid Sampling, ATR	6, 7, 10, 15, 18, 21, 26, 29, 32
Liquid Sampling, Transmission	97, 89, 99, 100, 101, 102
Long-Path Gas Cells	123
Long-Path Quartz Liquid Cells	100, 141

M

Magnetic Film Holder	113
MappIR Automated Wafer Analyzer	131
MAP300 Automated Wafer Analyzer	131
Materials, IR Properties	128
Micro Compression Cell	85, 86
Micro Diamond Compression Cell	86
μMAX IR Microscope	82
Micro Plane	85
Microplate Reader	47, 95, 153
Microscope, Heated Stage	87
Microscope, μMAX	82
Microtiter Plates	47, 95, 153
Micro TouchPick Pen	85
MIRacle ATR Accessory	10
Mirror, Alignment 30Spec and 45Spec	55
Mirror, Alignment 10Spec, 80Spec and VeeMAX III	53, 54, 56
Mirror, Alignment UV-Vis Spec Accessories	149, 150, 151, 152
Monolayer Analysis	29, 52, 56
Mortar and Pestle	112
Motorized Polarizer	62, 147, 148
Motorized VeeMAX III	29, 52
Mull Cell	97
Mull Agents	112
Multi-Reflection ATR	6, 12, 21, 26, 34, 36
Multi-SampIR, Transmission	92, 94

N

NaCl Disks/Windows	114
NaCl Properties	128
NIR, AutoDiff	46
NIR, Heated Transmission	103
NIR, Diffuse Reflectance	42, 43, 45, 46, 47, 77
NIR Falcon Accessory	103
NIR, XY Autosampler	47, 95
NIST Traceable NIR Standard	157, 158
NIST Traceable Polystyrene Film	156
Nujol	112

O

Oil in Water Analysis	100, 141
Optical Materials	114
Ordering Information	166

P

Parallelogram ATR Crystal	36
Pellet Press	105, 106, 107, 108, 109
Peltier Cuvette Holders	140, 142
Pestle and Mortar	112
PIKECalc Software	159
Pixie Hydraulic Press	2, 107
Plate Reader	47, 95, 153
Polarizers	62, 147, 148
Polyethylene Disk/Windows	114

Polyethylene Properties	128
Polystyrene Reference Material	158
Powder, KBr	106, 107, 108, 109, 112
Premium Sampling Kit	2
Press, Hydraulic	2, 107, 108, 109
Press-On Mull Cell	97
PressPRO Programmable Hydraulic Press	109

Q

Quartz Liquid Cells, Long-Path	100, 141
Quartz Cuvettes	140

R

RotatIR	93
---------	----

S

S100-R Heated Microscope Stage	87
Sampling Cards, Disposable	113
Sample Grinder	111
Sample Holders, Transmission	113
Sampling Kits	2–7
Sample Module, External	136
Sealed Liquid Cell	99
Semiconductor Applications	130, 131, 137
Semiconductor Wafers	130, 131, 137
ShakIR Sample Grinder	111
Short-Path Gas Cells	118, 119, 120, 121, 131
Si Disks/Windows	114, 116
Si Properties	128
Single Reflection ATR, GladiATR	15, 18
Single Reflection ATR, MIRacle	7, 10
Single Reflection ATR, VeeMAX III	29
SiO ₂ Disks/Windows	111
SiO ₂ Properties	128
SmartSeal Liquid Transmission Cell	99
Solid Sampling, Transmission	92, 93, 94, 96, 104
Spacers	97, 98
Spectral Databases	160, 161
Specular Reflectance Accessories	51

T

Temperature Control, Diffuse	41
Temperature Control, ATR	10, 14, 15, 18, 20, 21, 26, 29, 32
Temperature Control, Transmission	98, 100, 101, 102
Terms and Conditions	163
TGA/FTIR Accessory	131
Theory, ATR	35
Theory, Diffuse Reflectance	47
Theory, Integrating Sphere	69
Theory, Polarization	61
Theory, Specular Reflectance	57
Theory, Transmission	123
Transmission, Auto Samplers	90, 91, 92, 93
Transmission Liquid Cell	95, 96
Transmission Liquid Cell, Heated	98
Transmission Sampling Kits	2, 3, 4, 5

U

Ultima Sampling Kit	7
Universal Sample Holder	113
UpIR Diffuse Reflectance Accessory	45
UV-Vis 85Spec	151
UV-Vis Accessories	139
UV-Vis Cuvettes	140
UV-Vis Holders	141, 142
UV-Vis Instrument Codes	165
UV-Vis Polarizers	147, 148
UV-Vis Specular Reflectance Accessories	149, 150, 151, 152
UV-Vis VeeMAX	152

V

Vacuum Pump	43, 106, 108, 109
Value-Line Sampling Kit	6
Variable Angle ATR, ATRMax II	26
Variable Angle ATR, VeeMAX III	29
Variable-Path Gas Cell	123
VATR	36
VeeMAX III, ATR	29
VeeMAX III, Motorized	29, 52
VeeMAX III, Specular Reflectance	52
VeeMAX, UV-Vis Specular Reflectance	152
Vertical Wafer Transmission Accessory	130

W

Wafer Analyzers	130, 131, 137
Windows Properties	128
Windows/Disks	114–116
Wire-Grid Polarizers	62

X

XY Autosampler, Diffuse Reflectance	47
XY Autosampler, Transmission	95

Z

ZnS Disks/Windows	114
ZnS Properties	128
ZnSe Disks/Windows	114
ZnSe Properties	128

FTIR AND UV-VIS INSTRUMENT CODES

When ordering a PIKE accessory, replace the **XX** or **XXX** portion of the product's part number with your spectrometer's instrument code below. For assistance, please contact a PIKE customer service representative at (608) 274-2721 or info@piketech.com.

FTIR INSTRUMENT CODES (XX)

ABB Bomem

FTLA2000-100 (Arid Zone)	80
Michelson 100, MB Series	81
MB 3000	82

Agilent

Excalibur™, Scimitar™, FTS, 600-IR Series	10
Excalibur™, Scimitar™, 600-IR Series with recognition	13

Analect (See Hamilton Sundstrand)

Bio-Rad (See Agilent)

Bruker Optics

IFS™, Vector™, Equinox™ Series.	50
Tensor™, Vertex™ with recognition (Quick-Lock)	51

Buck Scientific

M500	65
------	----

Digilab (See Agilent)

Hamilton Sundstrand AIT

Diamond 20	60
------------	----

Horiba

7000 Series	35
-------------	----

Interspectrum

Interspec 200-X	90
Interspec 300-X	91

Jasco

300/600 Series	56
400	57
4000/6000 Series	58

JEOL

Winspec™ Series	46
-----------------	----

Lambda Scientific

Lambda FTIR 7600	66
Lambda FTIR 8600	64

Lumex

INFRALUM FT-02	67
INFRALUM FT-08	68

Mattson (See Thermo)

Midac

M Series	30
----------	----

Nicolet (See Thermo)

Oriel	95
-------	----

PerkinElmer

1700 Series	70
Spectrum™ GX, 2000	71

PerkinElmer, continued

Spectrum BX / RX, 1600, Paragon 1000	73
Frontier, Spectrum One, 65, 100, 400 with recognition	74
Spectrum Two with recognition	75

Shimadzu

8300, 8400 Series, IRPrestige™-21, IRAffinity-1s	15
IRPrestige™-21, IRAffinity-1s with recognition (QuickStart)	16
IRTracer™-100	18
IRTracer™-100 with recognition	19
IRSpirit	11
IRSpirit with recognition	12

Thermo / Nicolet / Mattson

Infinity, Galaxy, RS Series	20
Genesis™, Satellite, IR 300	21
Impact™ 400, Magna, Protege™, 500 / 700 Series	40
Avatar™, Nexus™, Nicolet™, iS™10, iS™50	40
Model 205/210	41
Nicolet iS™5	42
Avatar, Nexus, Nicolet Series with recognition (Smart)	47

Varian (see Agilent)

UV-VIS INSTRUMENT CODES (XXX)

Agilent/Varian

Cary 50	100
Cary 60	111
Cary 100, 300	110
Cary 4000, 5000, 6000i	120

Jasco

600 Series	600
------------	-----

Oriel

	900
--	-----

PerkinElmer

Lambda 650, 750, 850, 950 and 1050	700
Lambda 365	710
Lambda 25, 35, 45	730

Shimadzu

1600 and 1700	200
1800 Series	210
2600	240
3600	220

Thermo Fisher Scientific

Evolution 300/600	400
Evolution 200	410

ORDERING TERMS, CONTACT INFORMATION AND GUARANTEE

PART NUMBERS AND PRICE

The PIKE price list includes accessories that may be used with a variety of makes and models of spectrometers. Please specify the part number and description when ordering, including your instrument type and model number. See page 164 for a list of spectrometer and spectrophotometer instrument codes. When placing an order, substitute these codes for the final digits (XX) or (XXX) in the accessory part number.

PIKE Technologies is continually extending the accessory product range. If you are unable to find a required item, please contact us to discuss your needs. We will be glad to assist.

PAYMENT TERMS

Purchase Order Number, cash in advance, MasterCard and Visa are acceptable. Payment is net 30 days, and shipments are FOB Madison, WI USA. Freight charges are prepaid and added to your invoice. If you wish to pay freight charges, please specify this on your order. Prepayment is required for international customers.

INTERNATIONAL HANDLING FEE

For orders placed from outside the United States or Canada, a handling fee of \$40 will apply per order to cover the costs associated with the additional documentation and bank charges required for international shipments.

WAYS TO ORDER

Many products are available for purchase directly through our website. These items are marked on our website with a red shopping cart icon.

Please include the following information when placing an order: your name, phone number, product part number, quantity, ship to address, bill to address, purchase order number and spectrometer model on which the accessory will be used.

Orders may be placed via mail, phone, fax, e-mail or on our website. We accept Visa and MasterCard via phone and direct online purchases. For security purposes, do not send credit card information via e-mail. An electronic order form is available on our website (for P.O. Numbers only – do not use this form for credit card orders). There is no minimum order requirement. Please use the following addresses and phone/fax numbers when placing your orders:

PIKE Technologies, Inc.
6125 Cottonwood Drive
Madison, WI 53719
(608) 274-2721 (TEL)
(608) 274-0103 (FAX)
orders@piketech.com (E-MAIL)
www.piketech.com

DELIVERY

The delivery/shipment date is confirmed upon receipt of an order. Special requirements and custom accessories are subject to different lead times. Please contact us for price quotes and delivery information on these products.

GUARANTEE

All PIKE products are guaranteed to be free from defects in material and workmanship for a period of 12 months from the date of shipment. Should you have any queries, please contact us immediately and we will promptly repair or replace the product at no charge.

PRODUCT RETURNS

Please contact PIKE to receive your Return Material Authorization (RMA) number if you wish to return any of our products. A restocking fee may apply. Customers are responsible for shipping charges for all returned products. For products under warranty, back-to-customer shipping charges will be covered by PIKE. Please do not return any products without obtaining the RMA number first.

TECHNICAL ASSISTANCE

PIKE Technologies offers comprehensive technical assistance. Please contact us via mail, phone, fax or e-mail with your questions.

INTERNATIONAL DISTRIBUTION

PIKE Products are available worldwide. Call or send us an e-mail and we will provide you with an address of the sales office closest to your location. All exports are handled in accordance with the US Export Administration Regulations.

PIKE ON THE WEB

Visit our web site to find out more information about new products, up-to-date PIKE news, pricing, and to see the latest copy of the PIKE Reflections Newsletter! www.piketech.com • info@piketech.com

Customer satisfaction is very important to all of us here at PIKE Technologies, Inc. We have hopefully made the ordering process very fast and easy for you. If you have any questions or concerns about our products or services, we encourage you to contact us. We will be happy to make adjustments to fit your needs.

Products and prices are subject to change without notification.

©2018 PIKE Technologies, Inc.

Horizon MB™ belongs to ABB; Luer-Lok™ belongs to Becton Dickinson; Equinox™, IFS™, Quick-Lock™, Tensor™, Vector and Vertex™ belongs to Bruker Optics Inc.; CAB-O-SIL® belongs to Cabot Corporation; Pyrex® belongs to Corning Glass Works; Delrin®, Kalrez®, Teflon®, and Viton® belong to E.I. du Pont de Nemours and Company; Interspec belongs to Interspectrum OU; Spectra Manager™ belongs to Jasco, Inc; Winspec™ belongs to JEOL; EMCOMPRESS® belongs to JRS Pharma; InfraLUM® and SpectraLUM/Pro® belongs to Lumex Ltd; Visual BASIC™ and Windows belongs to Microsoft Corporation; Fluorolube® belongs to OxyChem Corporation; Spectrum™ and Spectrum 10™ belongs to PerkinElmer, Inc; Nujol™ belongs to Schering-Plough; IRPrestige™ belongs to Shimadzu Corporation; Swagelok® belongs to Swagelok Company; Avatar™, Genesys™, Impact™, iS™5, iS™10, iS™50, Magna-IR™, Nexus™, Nicolet™, WinFirst™, OMNIC™ and Protégé™ belong to Thermo Fisher Scientific; Excalibur™, Resolutions Pro™ and Scimitar™ belong to Agilent, Inc. All other trademarks are the property of PIKE Technologies.

HELPFUL LINKS

[Order Form](#)

[Quote Request Form](#)

[International Sales Offices](#)

[Instrument Codes \(FTIR, UV-Vis\)](#)

[Application Notes](#)

[Video Library](#)

[Visit our Website](#)

[Contact Us](#)



PIKE
TECHNOLOGIES

6125 Cottonwood Dr.,
Madison, WI 53719
(608) 274-2721
info@piketech.com
www.piketech.com